

TECHNIK FÜR HOLZ- UND HOLZ-ALUFENSTER

SCHMIDT  **VISBEK**

Fenster. Türen. Innovationen.

INHALT

AUF KAPITEL KLICKEN,
UM AUF SEITE ZU GELANGEN!



HOLZFENSTER

IV 76 Standard	3
oben und unten Pfosten und Stulp Kämpfer mit Festverglasung Glasteilende Sprossen Festverglasung Blendrahmen-Unterstücke	
IV 76 S-Profil	34
oben und unten Pfosten und Stulp Kämpfer mit Festverglasung Glasteilende Sprossen	
IV 76 schmale Ausführung	55
oben und unten Stulp	
Holzfenstertür IV 76	62
unten mit Bodenschwelle auswärts öffnend	
Rahmenfestverglasung mit Falzwechsel	70
oben und unten	
IV 88 Standard	73
oben und unten Pfosten und Stulp Kämpfer mit Festverglasung Glasteilende Sprossen Blendrahmen-Unterstücke	
IV 88 S-Profil	86
oben und unten Pfosten und Stulp Kämpfer mit Festverglasung Glasteilende Sprossen Blendrahmen-Unterstücke	
Zubehör Holzfenster	94
Blendrahmen Sonderformen Eckverbindungen Schienenabdeckungen Deckleisten Rollladenführungen Zierprofile	

HOLZ-ALU FENSTER

DUO-86	108
oben und unten Festverglasung Pfosten und Stulp Kämpfer mit Festverglasung Sprossen unten mit Bodenschwelle	
DUO-96 mit Mira Schalen	134
oben und unten Festverglasung Pfosten und Stulp Kämpfer mit Festverglasung Sprossen	
DUO-96 mit Mira Contour Schalen	160
oben und unten Festverglasung Pfosten und Stulp Kämpfer mit Festverglasung	
DUO-83 Plano	186
oben und unten Festverglasung Pfosten und Stulp Kämpfer mit Festverglasung Sprossen unten mit Bodenschwelle	
DUO-100 Plano	212
oben und unten Festverglasung Pfosten und Stulp Kämpfer mit Festverglasung Sprossen unten mit Bodenschwelle	
Haustüren	236
Pronto Classico Holz-Alu Flächenbündig	

IV76

STANDARD

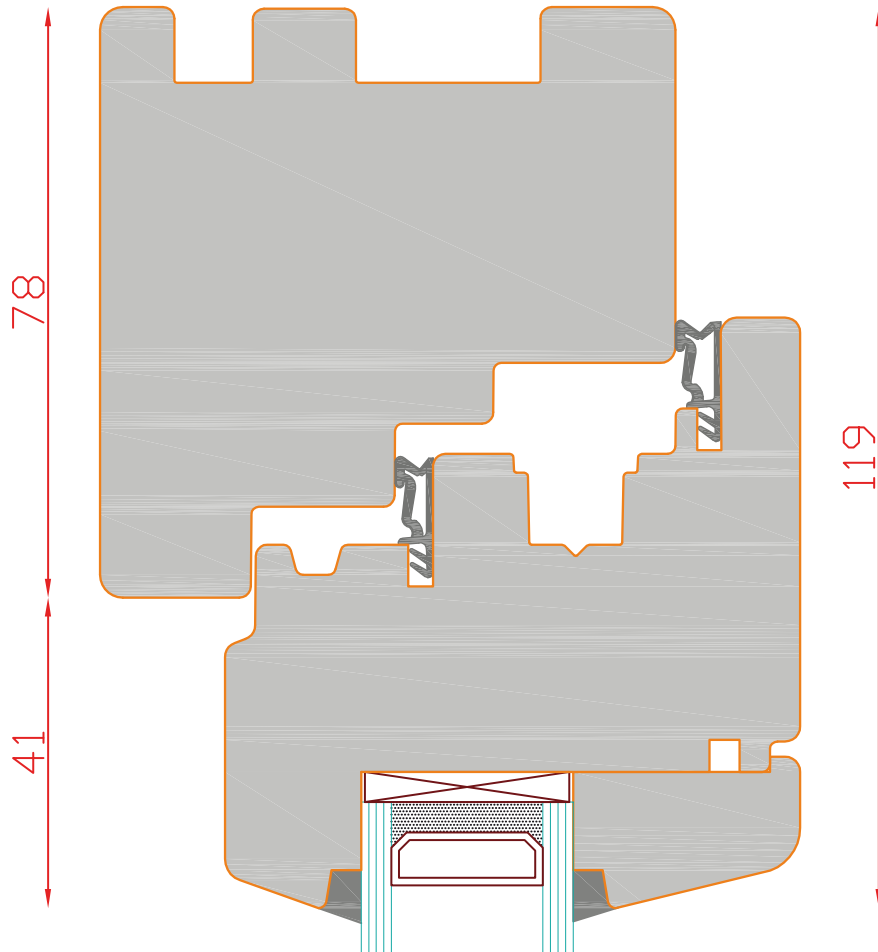
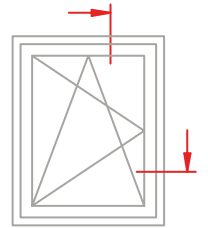

Glasstärken ab
28mm möglich



IV76
STANDARD

Schnitt : Vertikal oben und seitlich

Typ: DK

| Seite: 4

SCHMIDT VISBEK
Fenster. Türen. Innovationen.

Glasstärken ab
28mm möglich

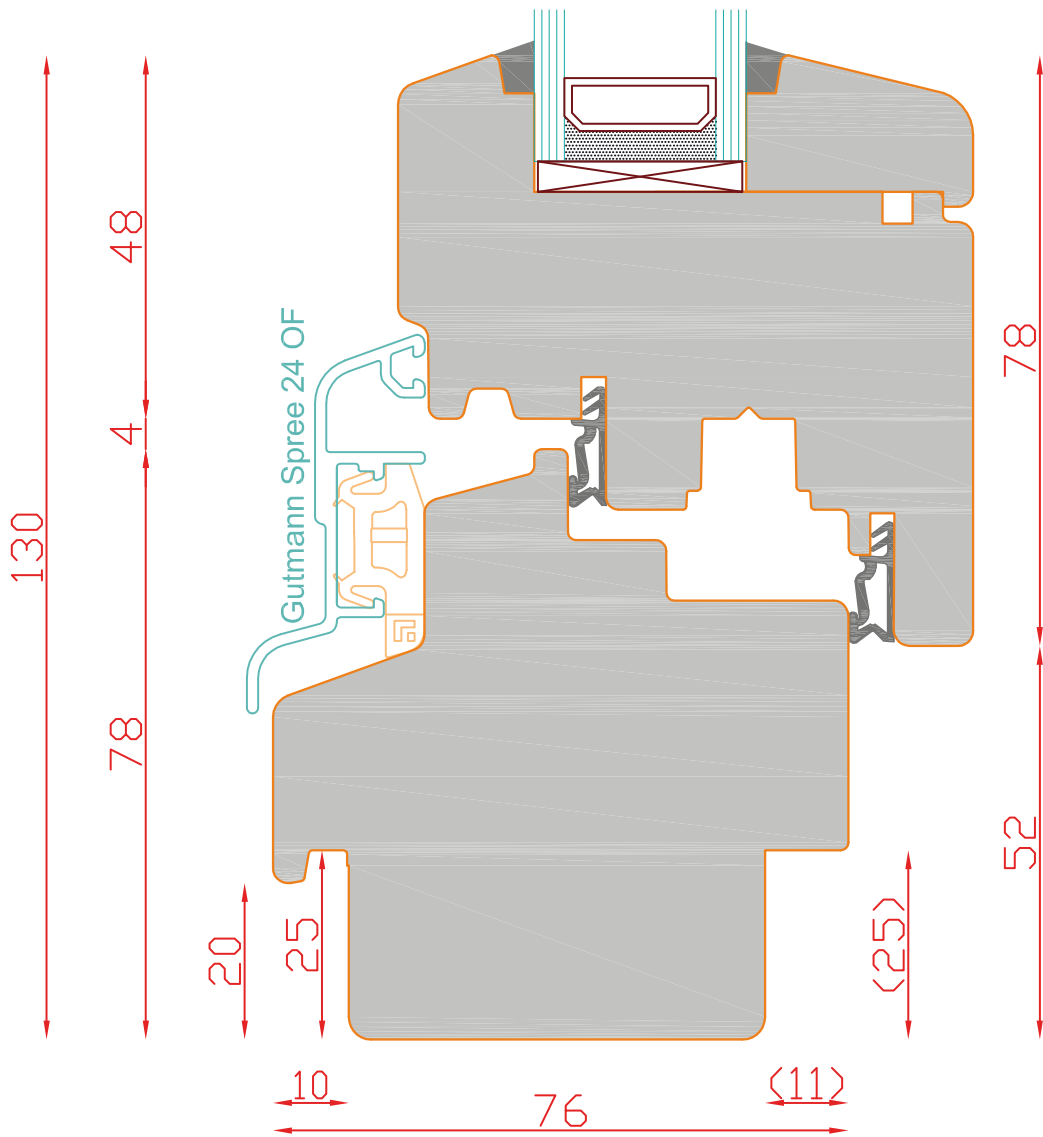
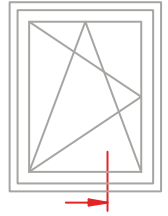

IV76
STANDARD

Schnitt : Vertikal unten

Typ: DK / Alu-Regenschiene

| Seite: 5



SCHMIDT VISBEK
Fenster. Türen. Innovationen.

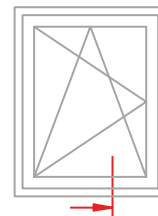

Glasstärken ab
28mm möglich

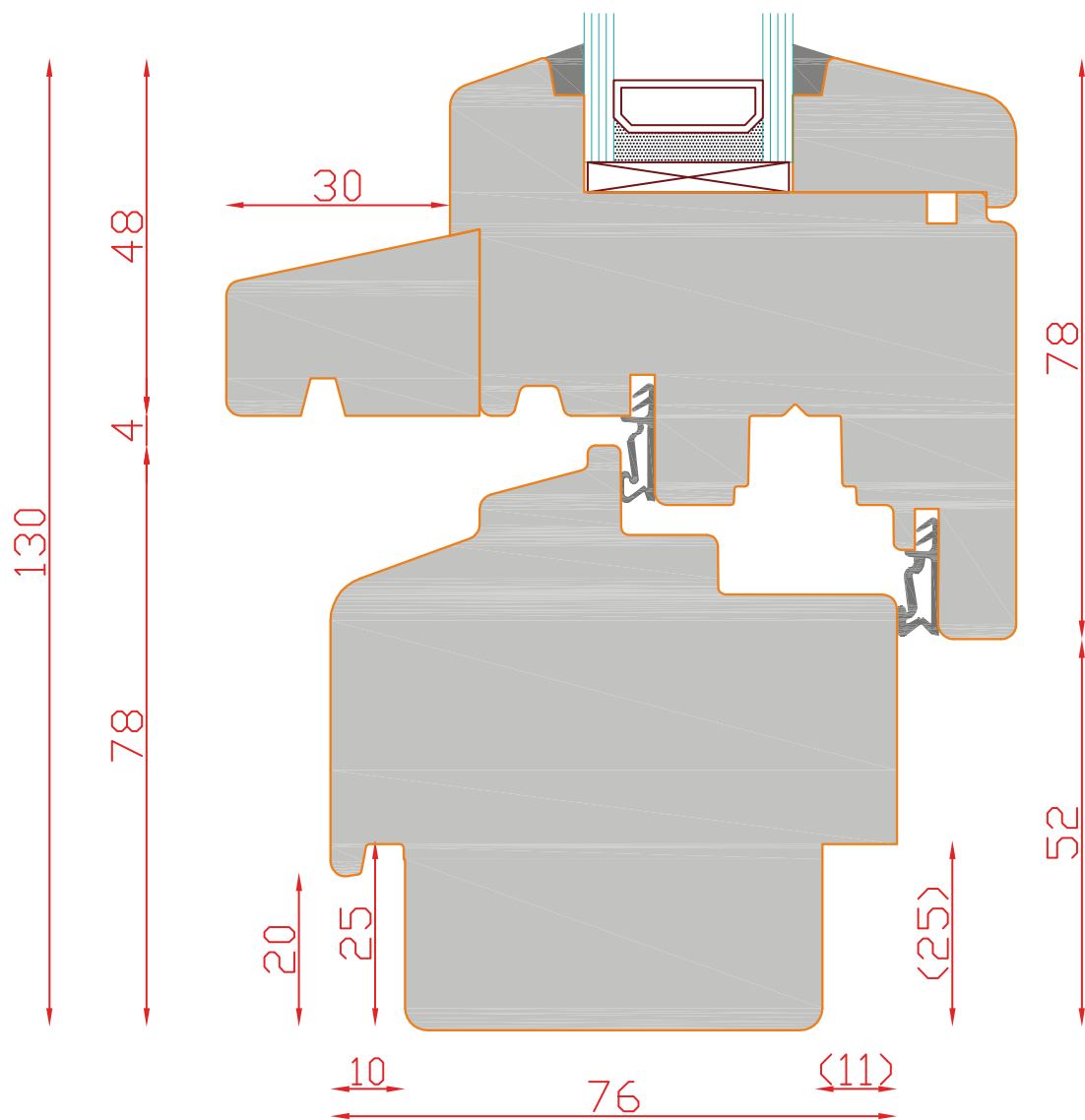

IV76
STANDARD

Schnitt : Vertikal unten

Typ: DK / ohne Regenschiene | Seite: 6

SCHMIDT VISBEK
Fenster. Türen. Innovationen.



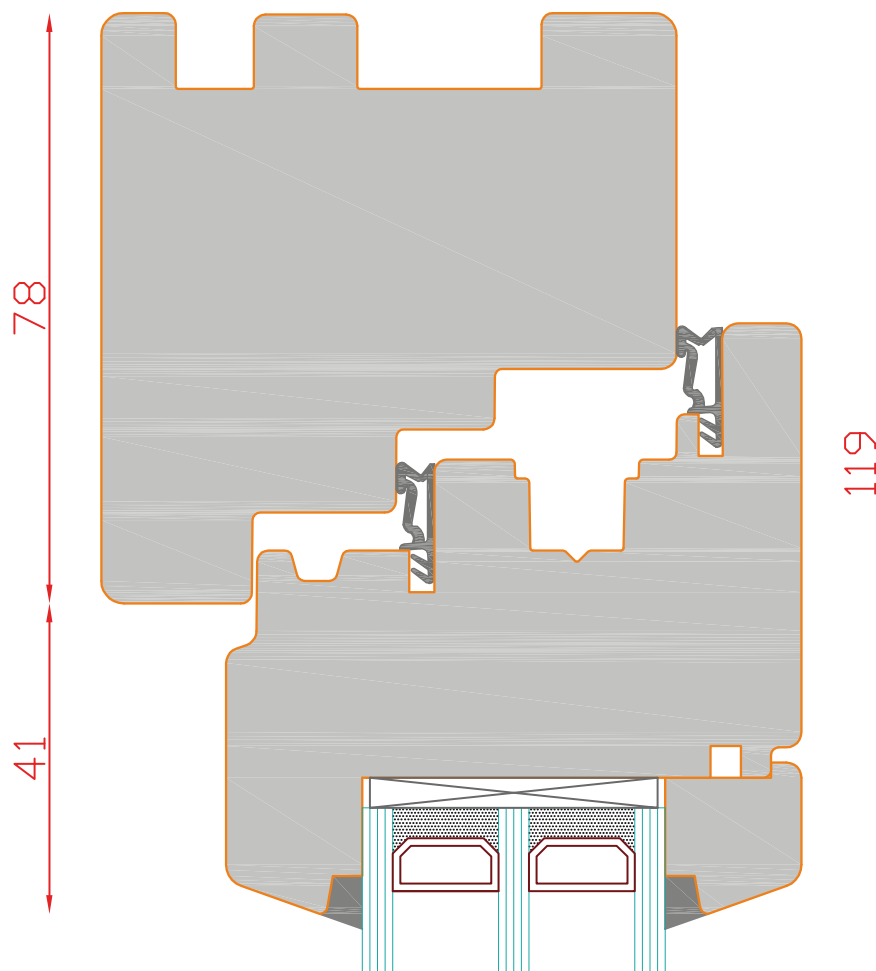
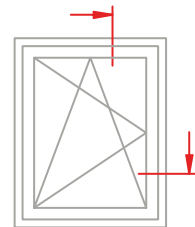

Glasstärken von
32mm-40mm möglich



IV76
STANDARD

Schnitt : Vertikal oben und seitlich

Typ: DK

| Seite: 7

SCHMIDT VISBEK
Fenster. Türen. Innovationen.

Glasstärken von
32mm-40mm möglich

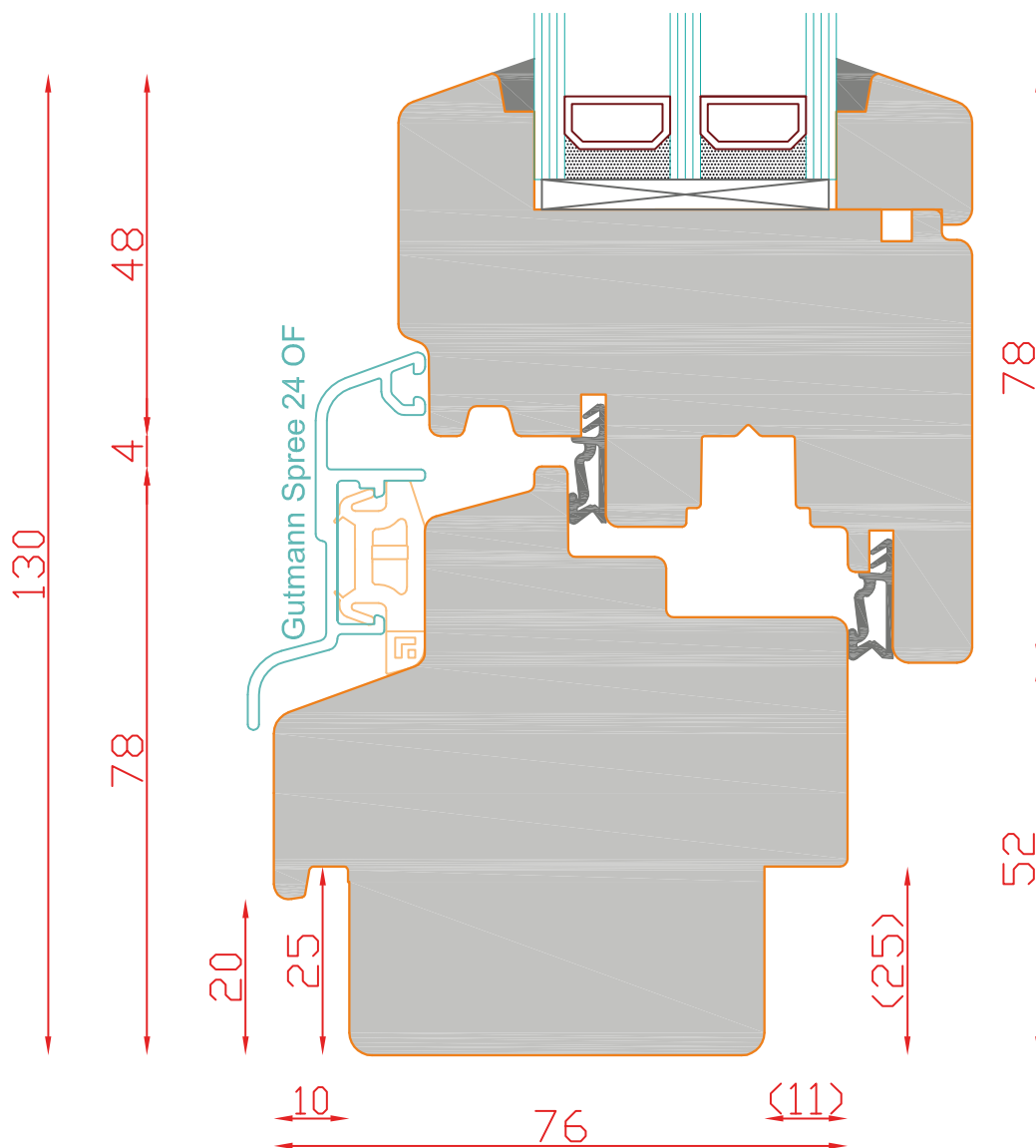
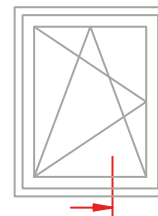

IV76
STANDARD

Schnitt : Vertikal unten

Typ: DK / Alu-Regenschiene

| Seite: 8



SCHMIDT VISBEK
Fenster. Türen. Innovationen.

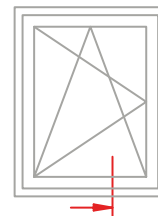

Glasstärken von
32mm-40mm möglich

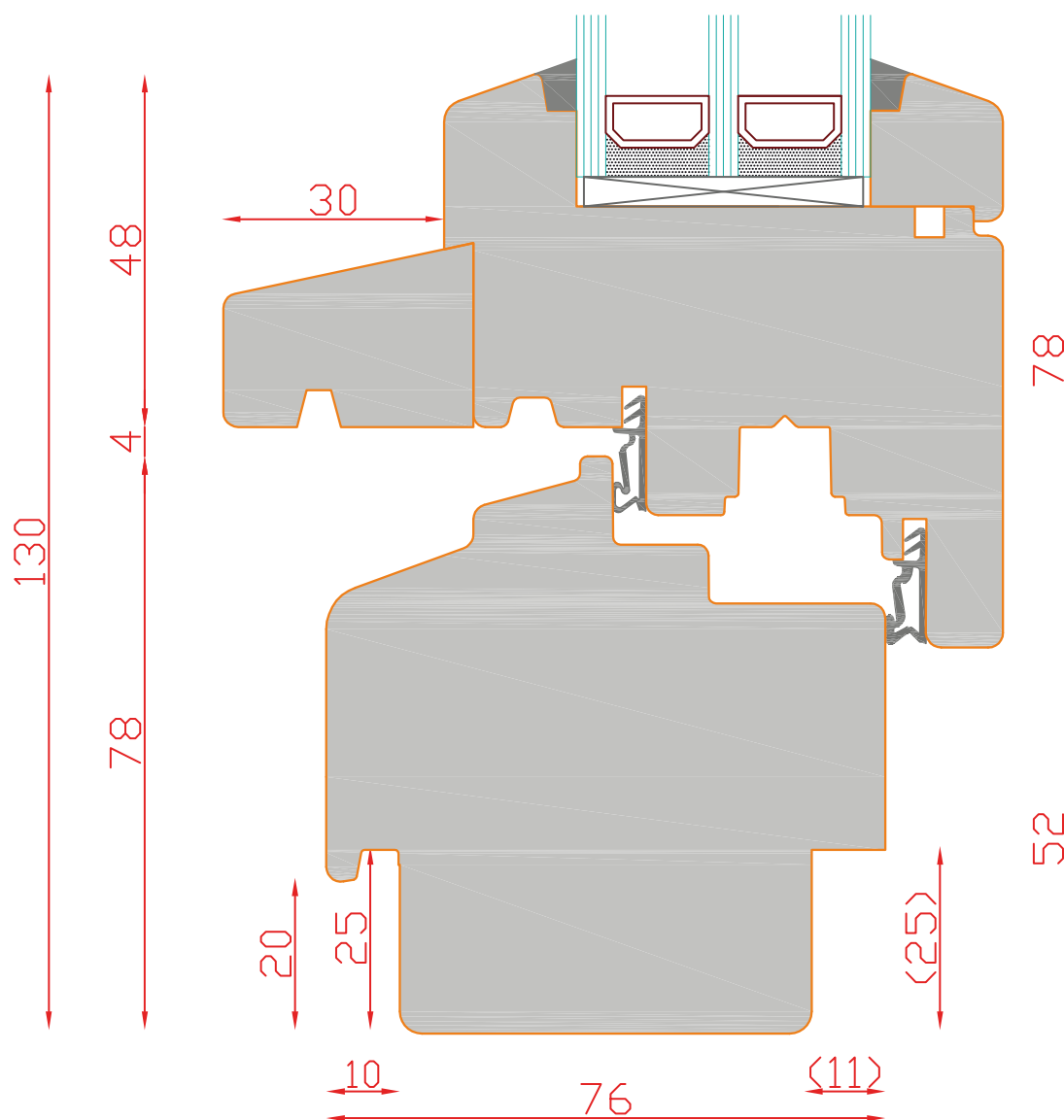

IV76
STANDARD

Schnitt : Vertikal unten

Typ: DK / ohne Regenschiene | Seite: 9

SCHMIDT VISBEK
Fenster. Türen. Innovationen.



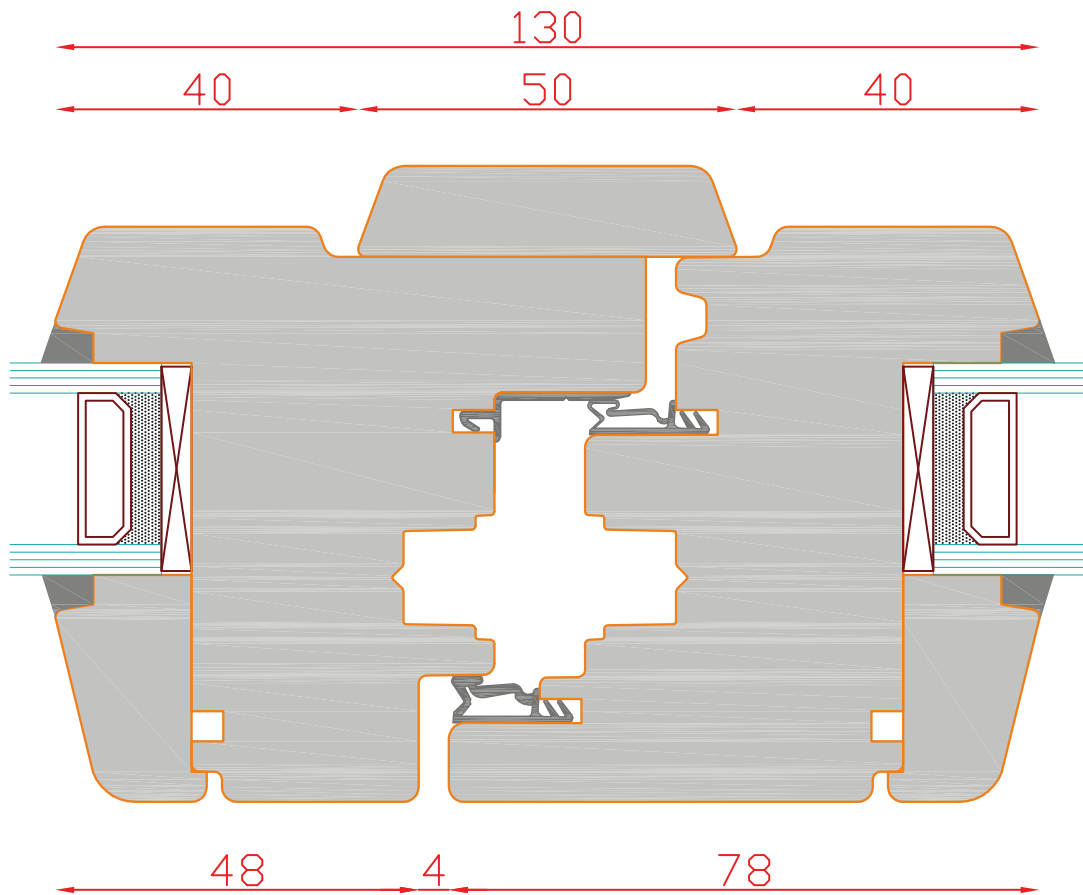
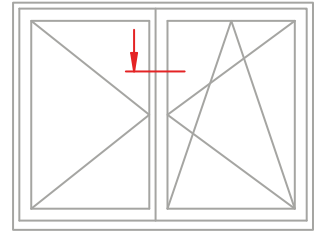

Glasstärken ab
28mm möglich



IV76
STANDARD

Schnitt :Horizontal / Stulp

Typ: D - DK / Schlagleiste aufgesetzt | Seite: 10

SCHMIDT VISBEK
Fenster. Türen. Innovationen.

Glasstärken ab
28mm möglich

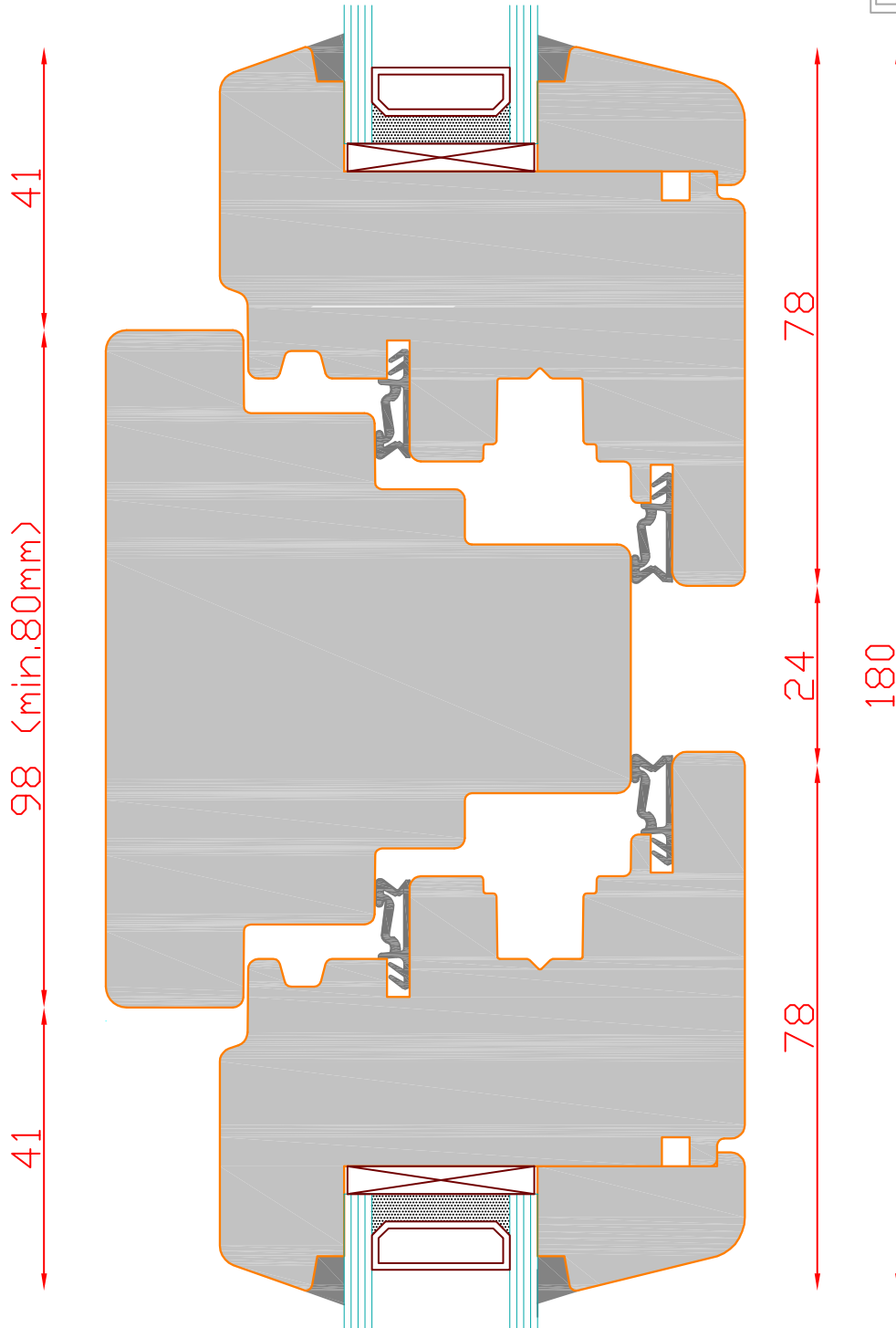
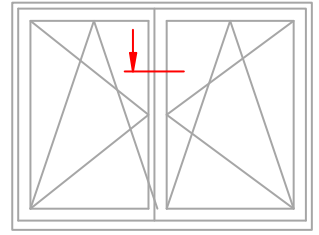

Glasstärken ab
28mm möglich



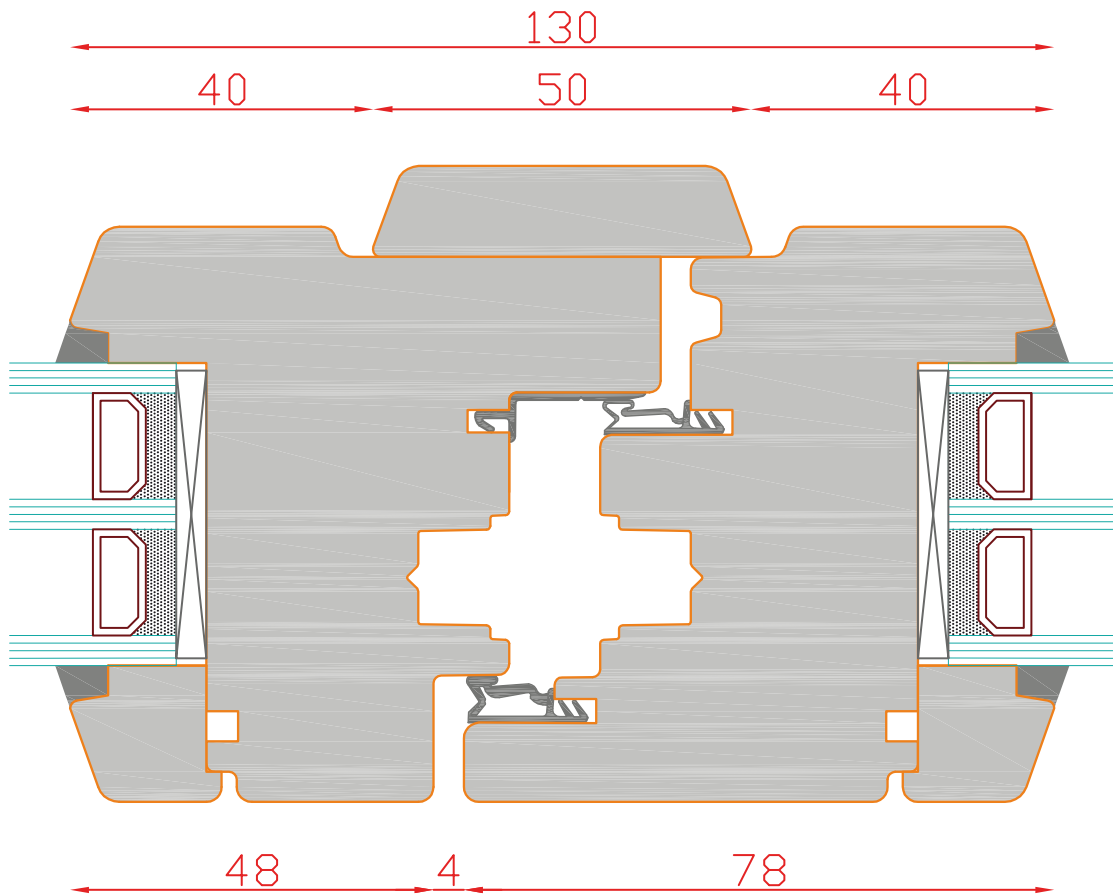
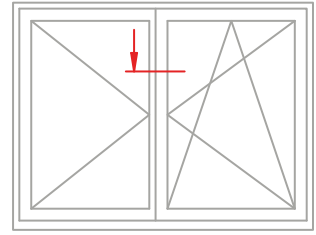

Glasstärken von
32mm-40mm möglich



IV76
STANDARD

Schnitt :Horizontal / stulp

Typ: D - DK / Schlagleiste aufgesetzt | Seite: 12

SCHMIDT VISBEK
Fenster. Türen. Innovationen.

Glasstärken von
32mm-40mm möglich

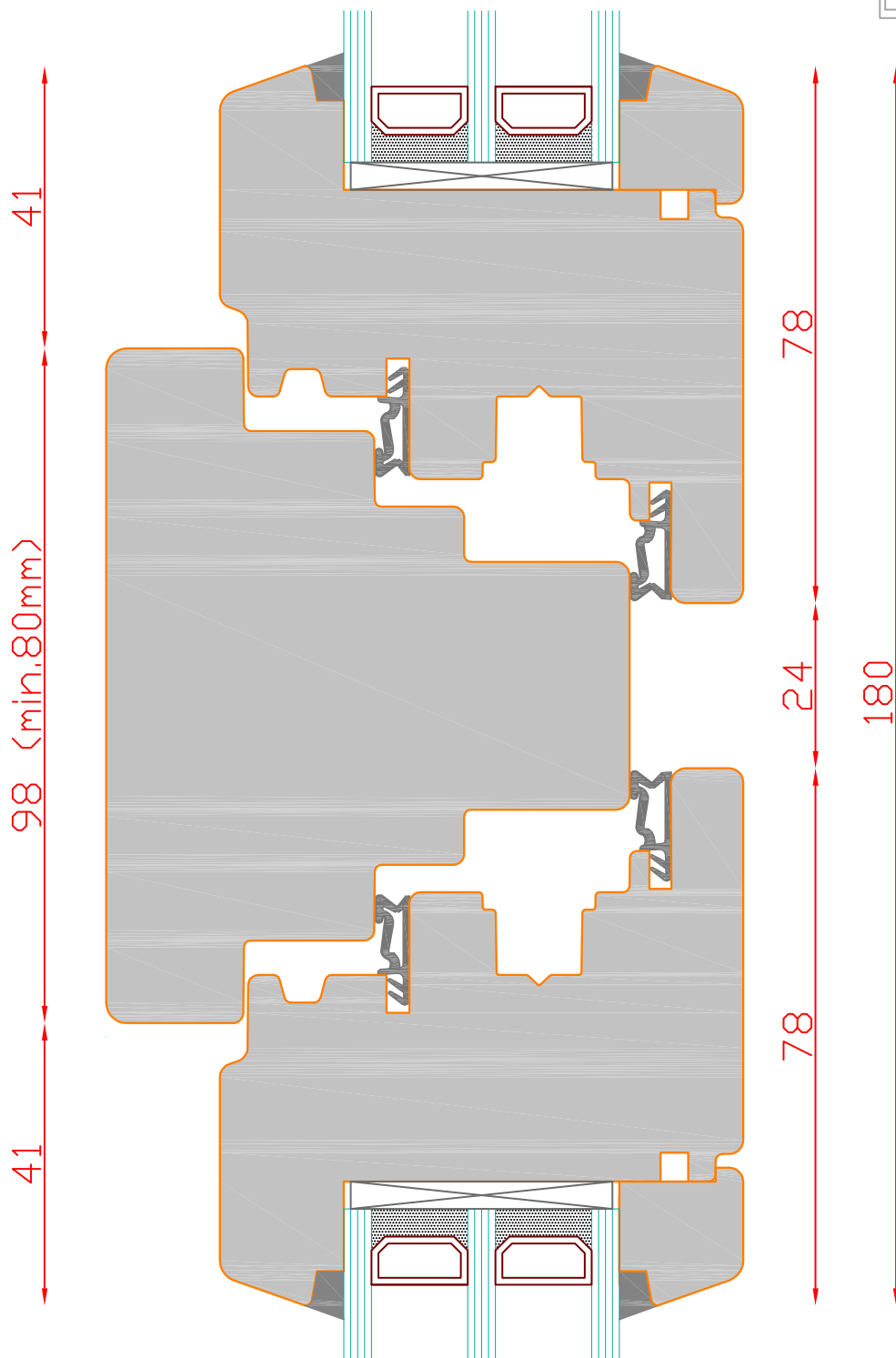
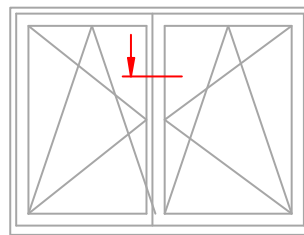

Glasstärken von
32mm-40mm möglich



IV76
STANDARD

Schnitt :Horizontal/ Pfosten 100mm

Typ: DK-DK

| Seite: 13

SCHMIDT VISBEK
Fenster. Türen. Innovationen.

Glasstärken ab
28mm möglich

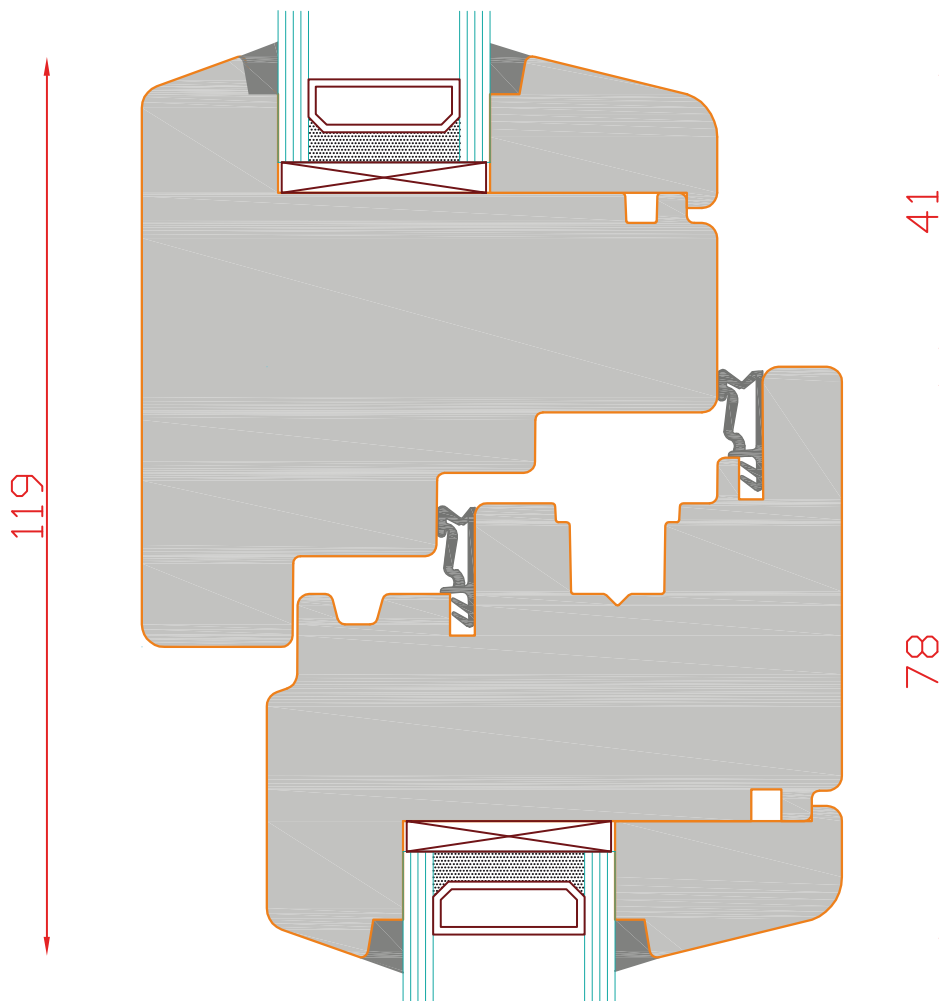
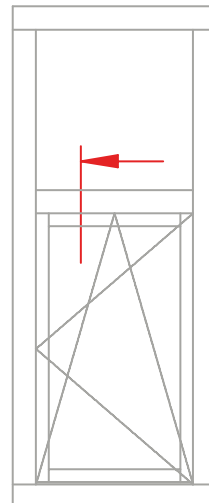

Glasstärken ab
28mm möglich



IV76
STANDARD

Schnitt : Vertikal Kämpfersituation

Typ: oben FIB / unten DK

| Seite: 14

SCHMIDT VISBEK
Fenster. Türen. Innovationen.

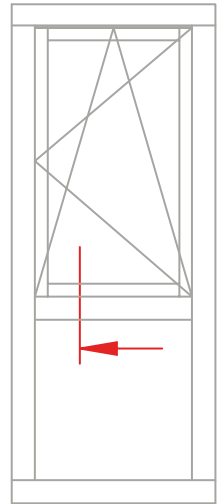

Glasstärken ab
28mm möglich

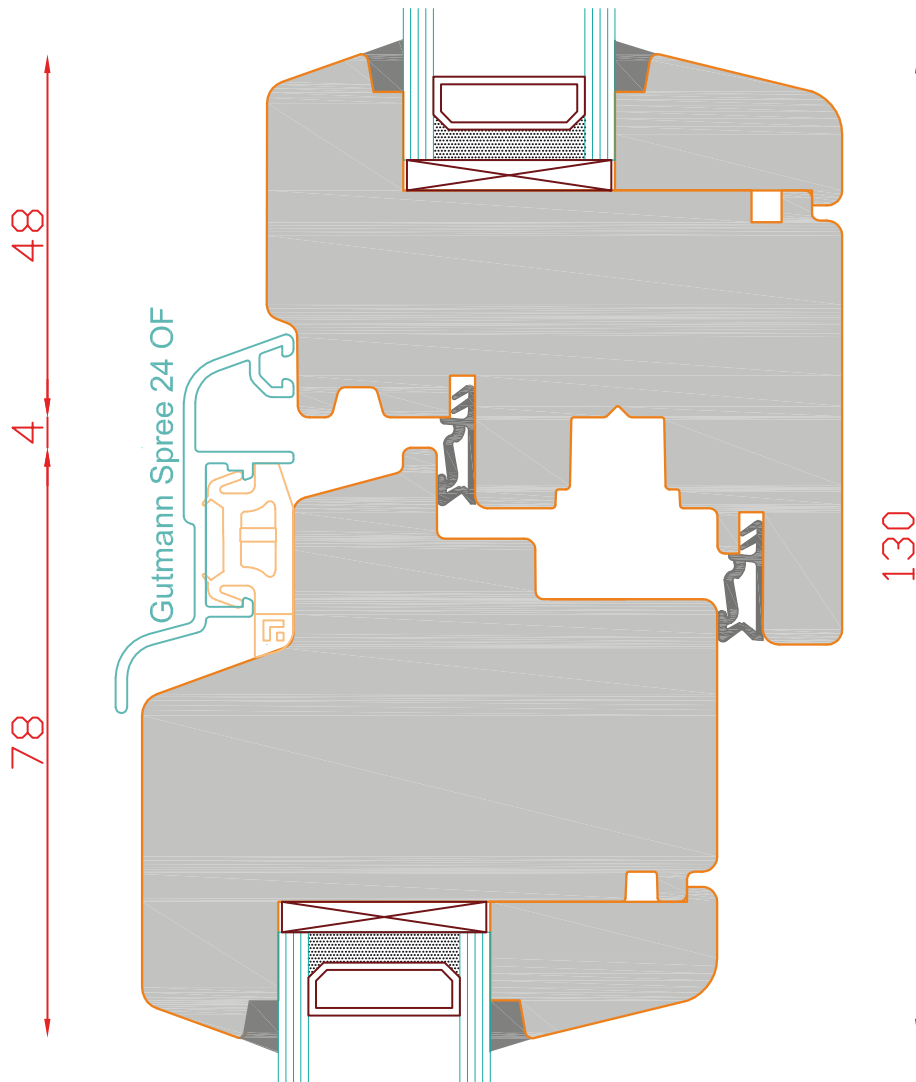

Glasstärken ab
28mm möglich



Glasstärken ab
28mm möglich

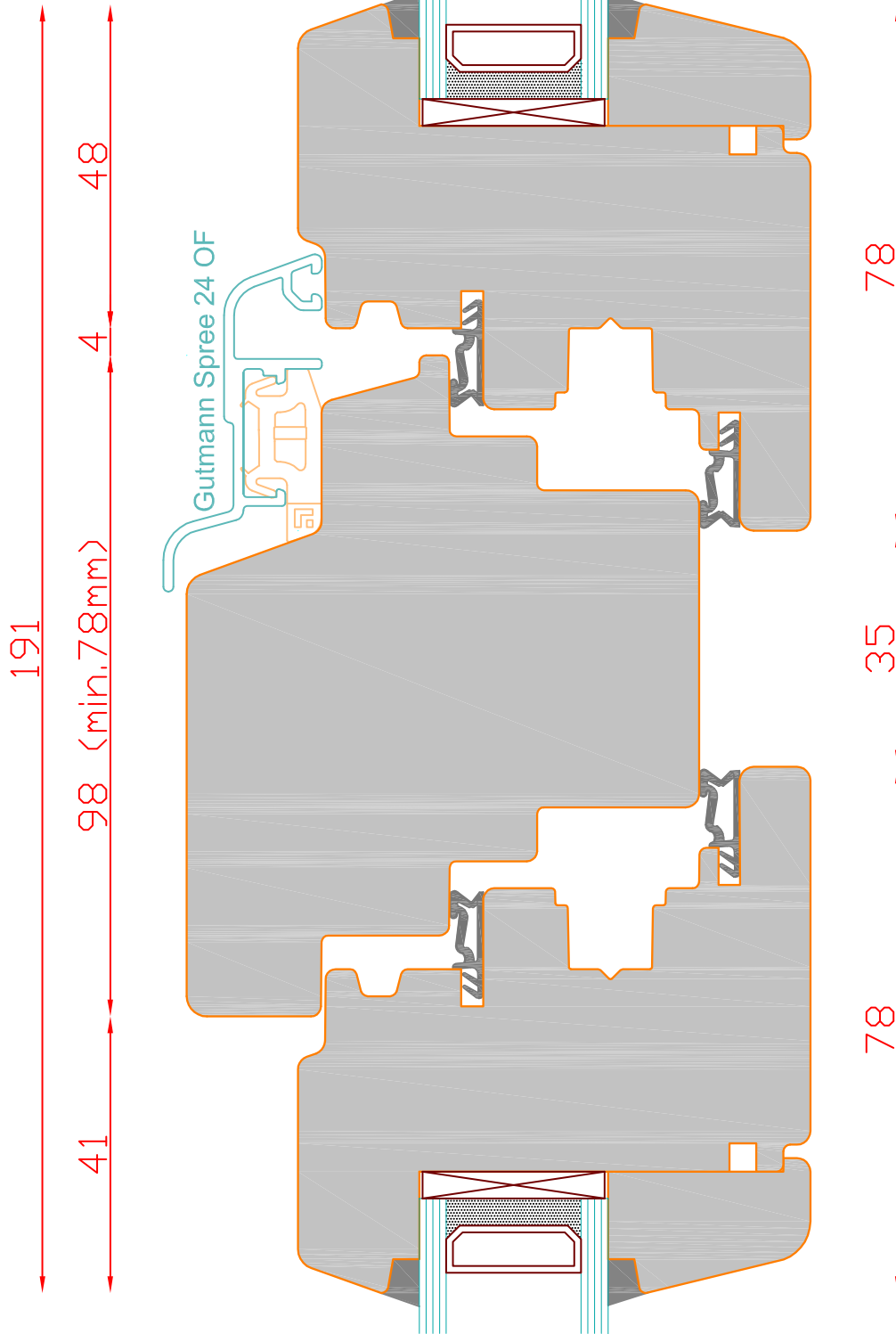
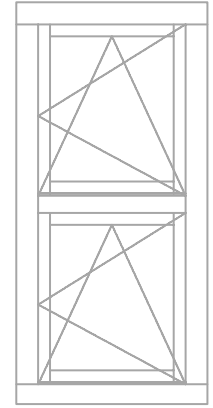

Glasstärken ab
28mm möglich



IV76
STANDARD

Schnitt : Vertikal Kämpfersituation

Typ: oben DK / unten DK

| Seite: 16

SCHMIDT VISBEK
Fenster. Türen. Innovationen.

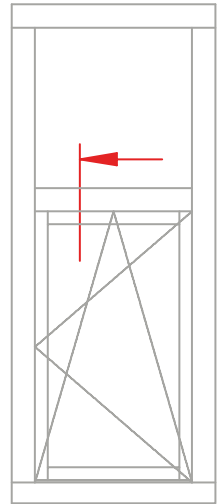

Glasstärken von
32mm-40mm möglich

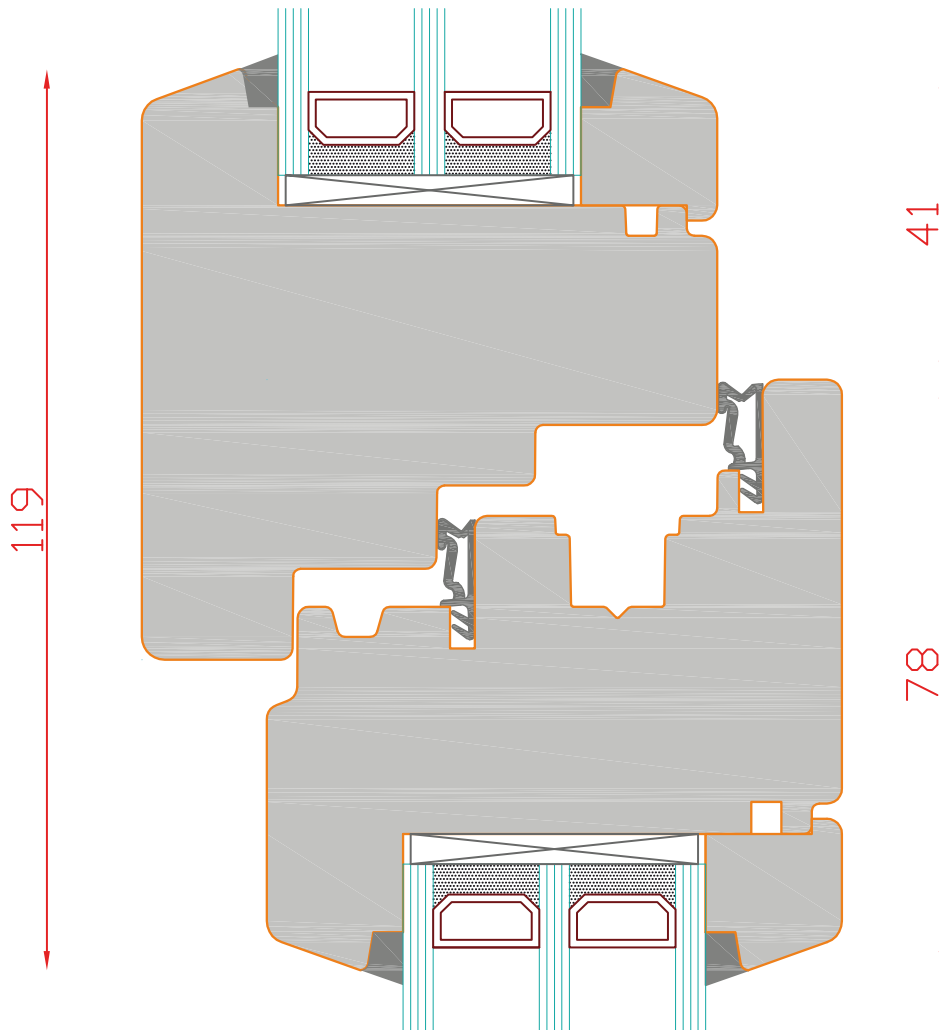

Glasstärken von
32mm-40mm möglich



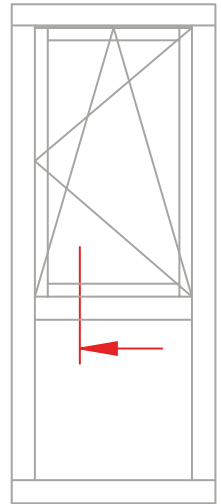

Glasstärken von
32mm-40mm möglich

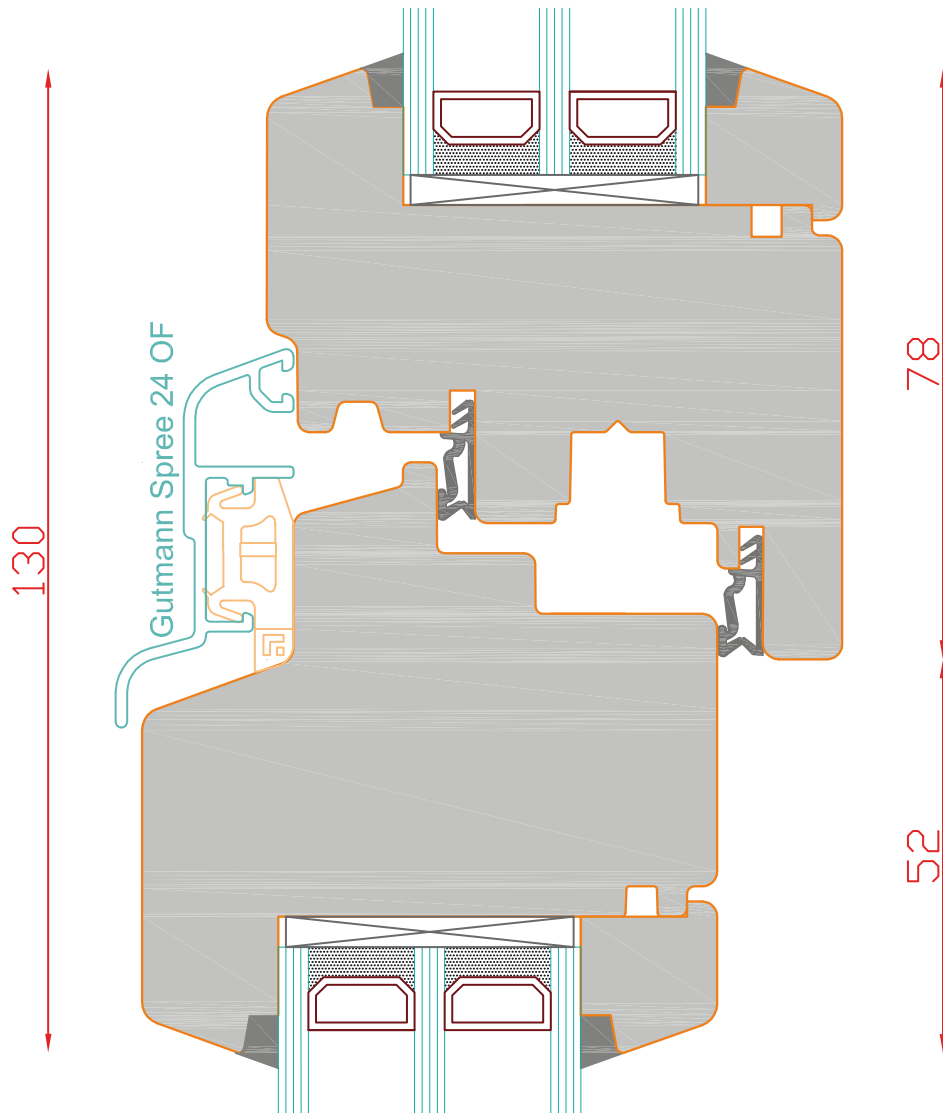

Glasstärken von
32mm-40mm möglich



Glasstärken von
32mm-40mm möglich

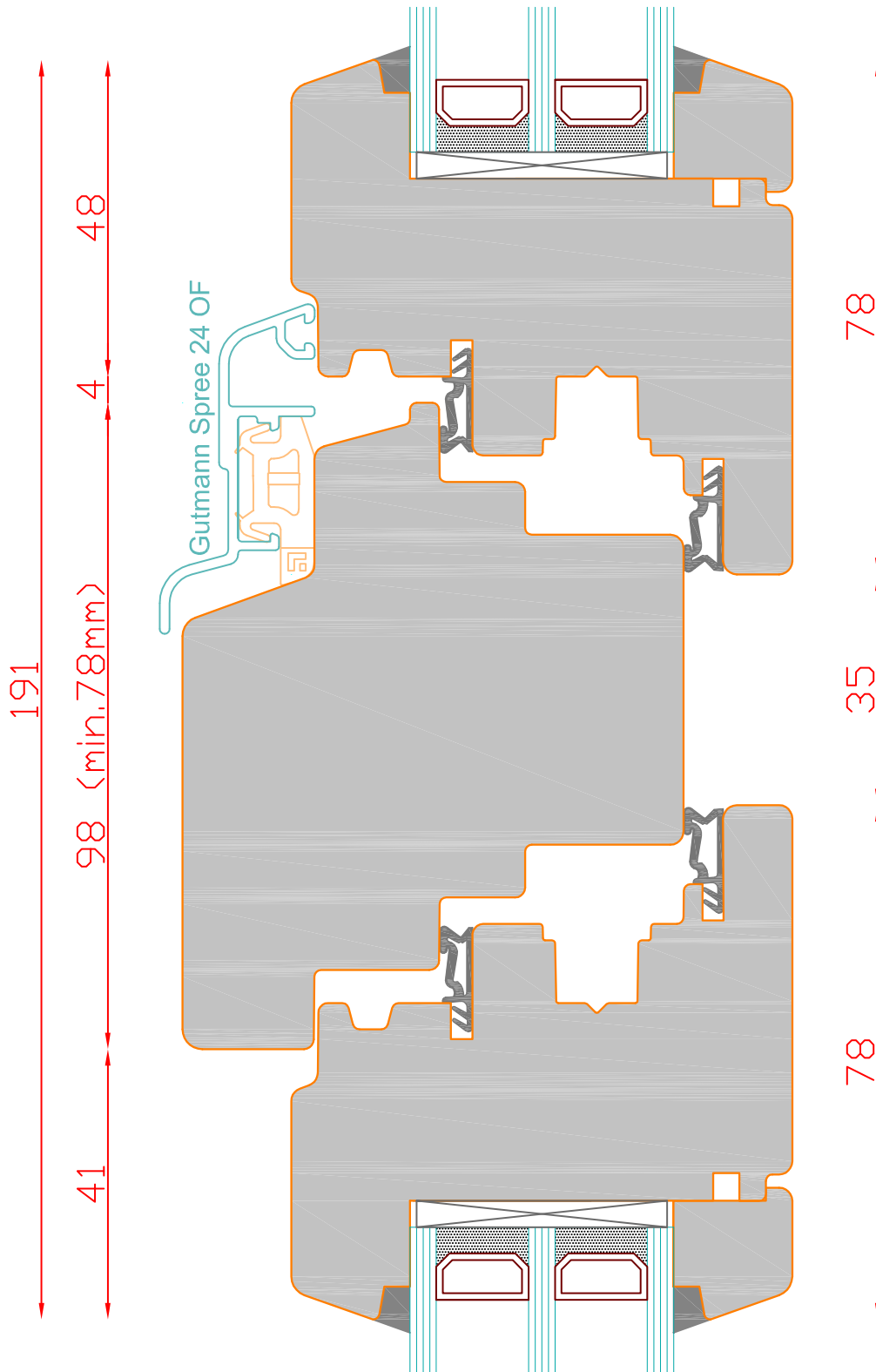
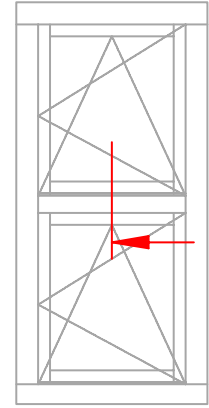

Glasstärken von
32mm-40mm möglich



IV76
STANDARD

Schnitt : Vertikal Kämpfersituation

Typ: oben DK / unten DK

Seite: 19

SCHMIDT VISBEK
Fenster. Türen. Innovationen.

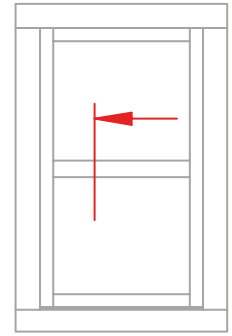

Glasstärken ab
28mm möglich

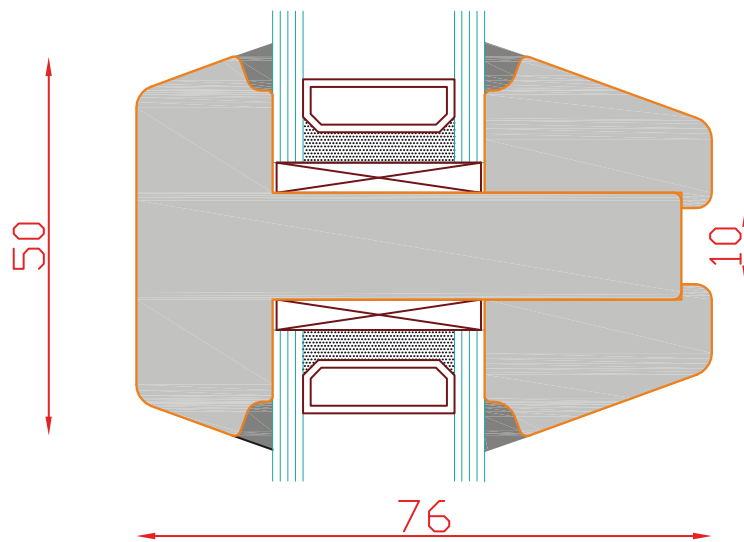

IV76
STANDARD

Schnitt : Vertikal 50mm Sprosse

Typ: Konter/Dübel

| Seite: 20

SCHMIDT VISBEK
Fenster. Türen. Innovationen.

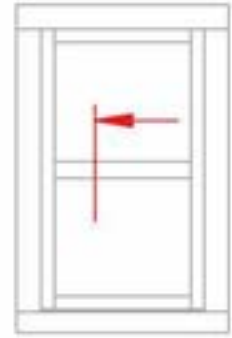

Glasstärken ab
28mm möglich

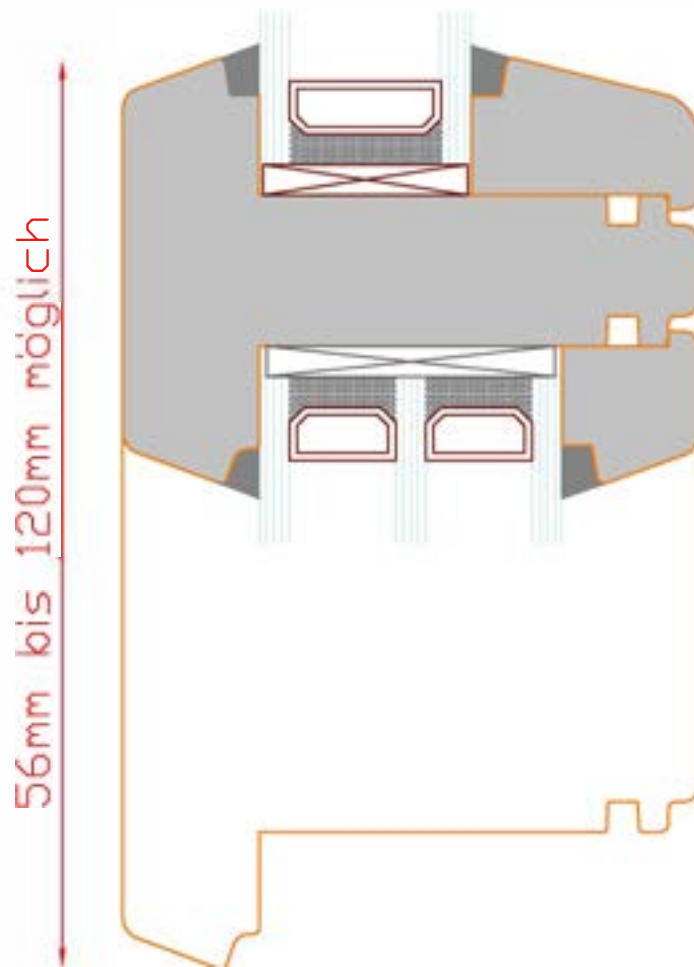

IV76
STANDARD

Schnitt : Vertikal 56-120mm Sprosse

Typ: Konter/Dübel

| Seite: 21

SCHMIDT VISBEK

Fenster. Türen. Innovationen.

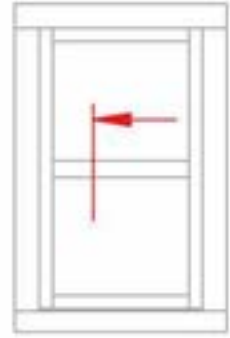

Glasstärken von
32mm-40mm möglich

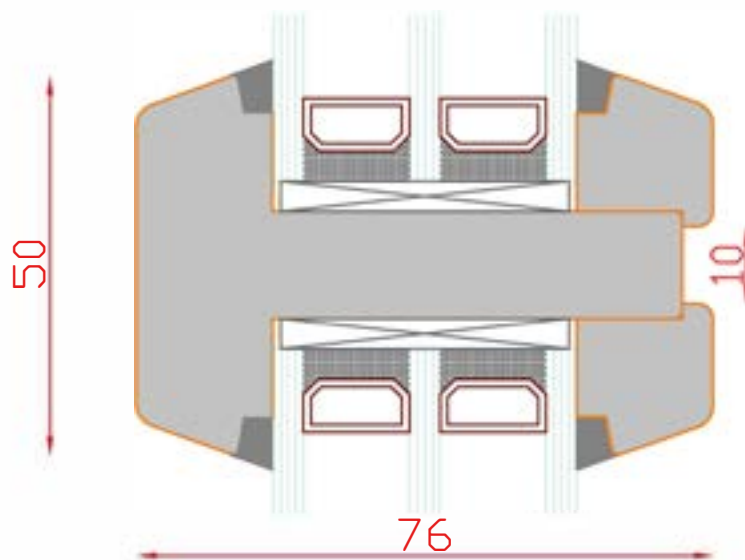

IV76
STANDARD

Schnitt : Vertikal 50mm Sprosse

Typ: Konter/Dübel

| Seite: 22

SCHMIDT VISBEK
Fenster. Türen. Innovationen.

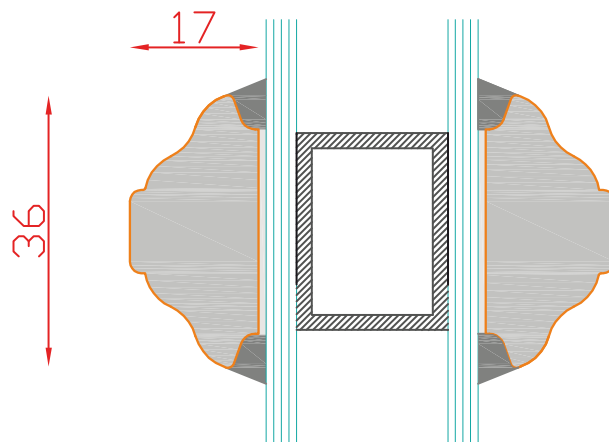
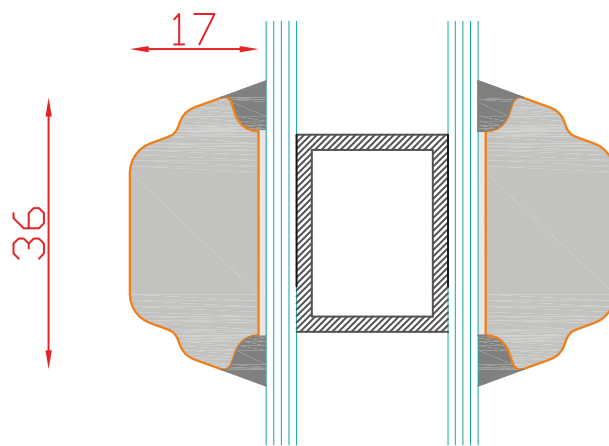
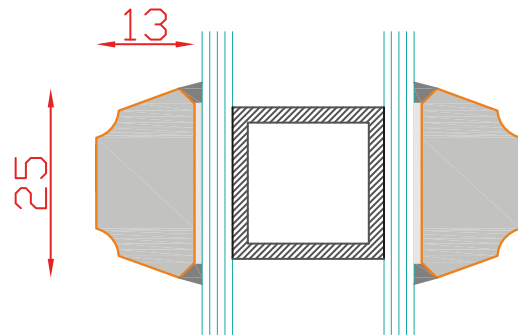
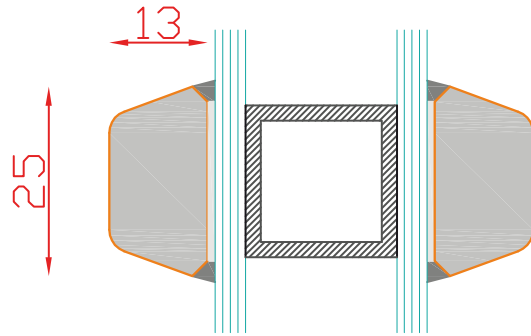
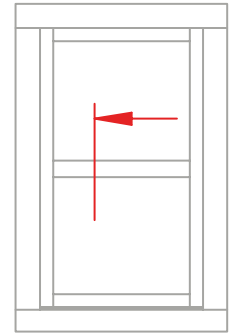

IV76
STANDARD

Schnitt : Vertikal

Typ: Sprossen, aufgeklebt

| Seite: 23

SCHMIDT VISBEK
Fenster. Türen. Innovationen.

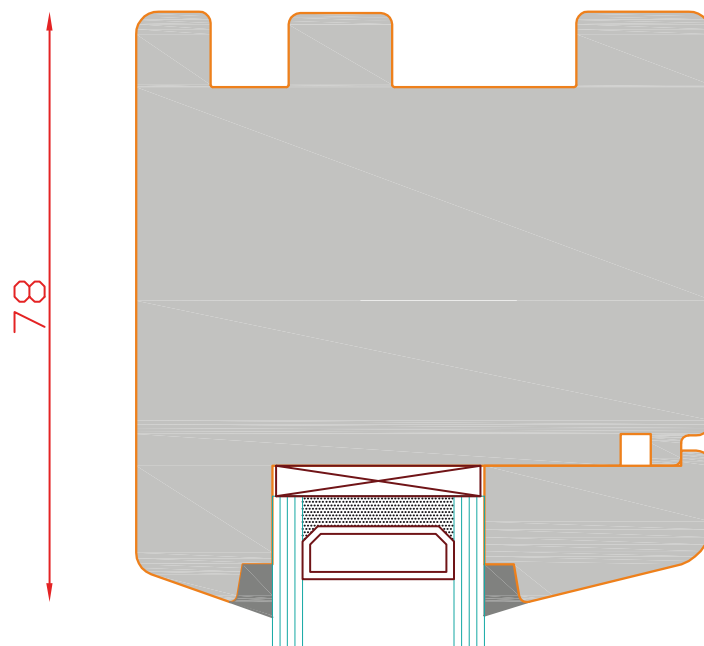
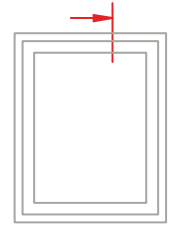

Glasstärken ab
28mm möglich



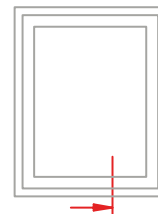

Glasstärken ab
28mm möglich

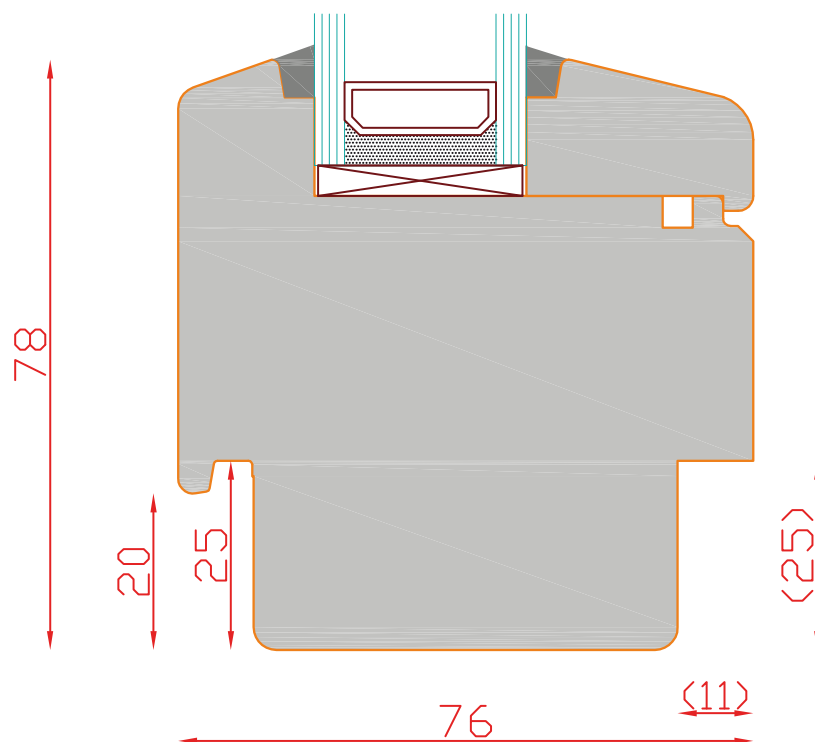

IV76
STANDARD

Schnitt : Vertikal unten

Typ: FIB

| Seite: 25

SCHMIDT VISBEK
Fenster. Türen. Innovationen.

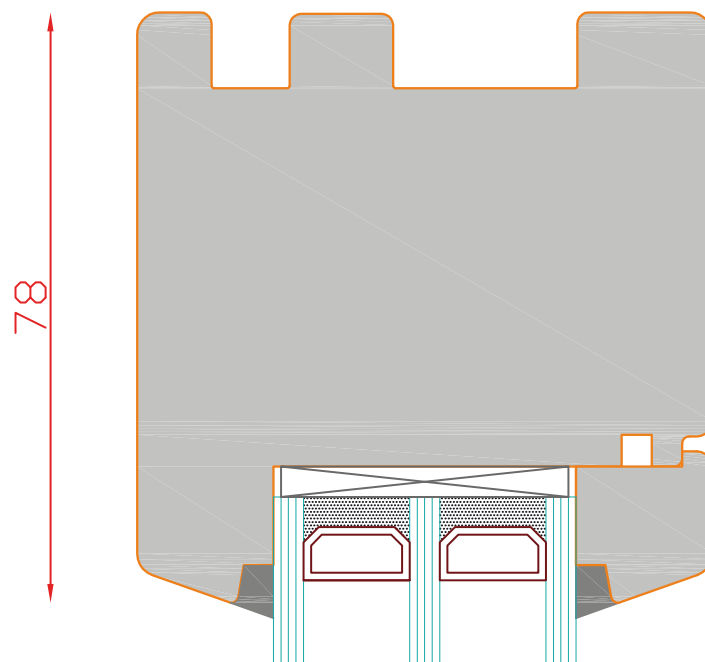
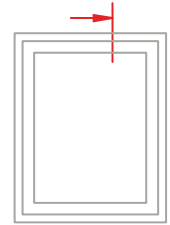

Glasstärken von
32mm-40mm möglich



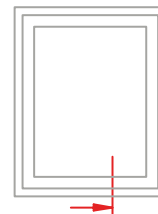

Glasstärken von
32mm-40mm möglich

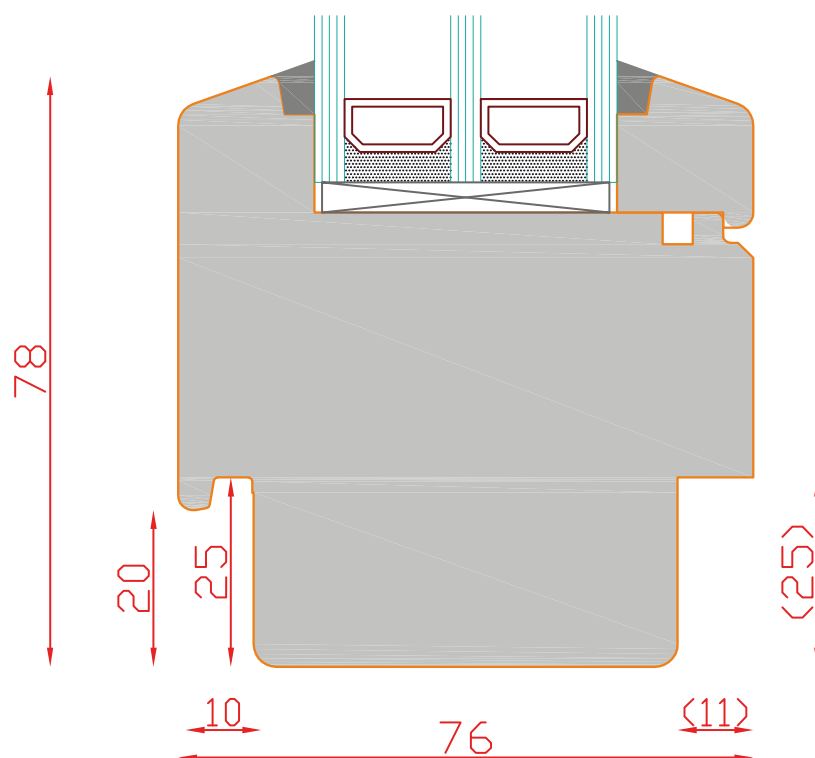

IV76
STANDARD

Schnitt : Vertikal unten

Typ: FIB

| Seite: 27

SCHMIDT VISBEK
Fenster. Türen. Innovationen.

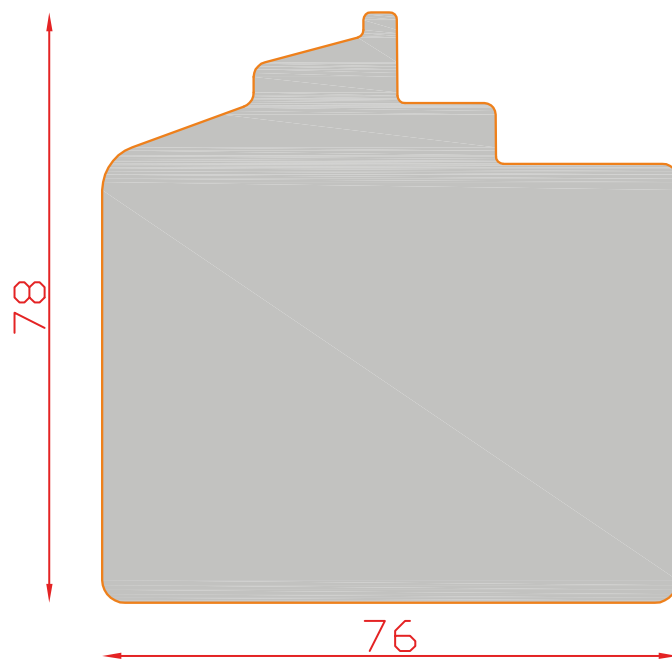

IV76
STANDARD

Schnitt : Vertikal

Typ: stumpf

| Seite: 28

SCHMIDT VISBEK
Fenster. Türen. Innovationen.

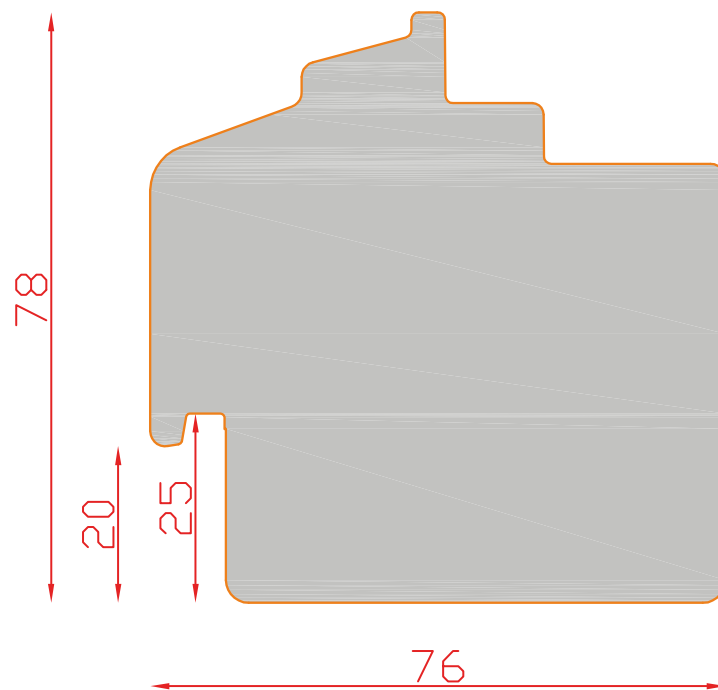

IV76
STANDARD

Schnitt : Vertikal

Typ: Alubankfalz außen

| Seite: 29

SCHMIDT VISBEK
Fenster. Türen. Innovationen.

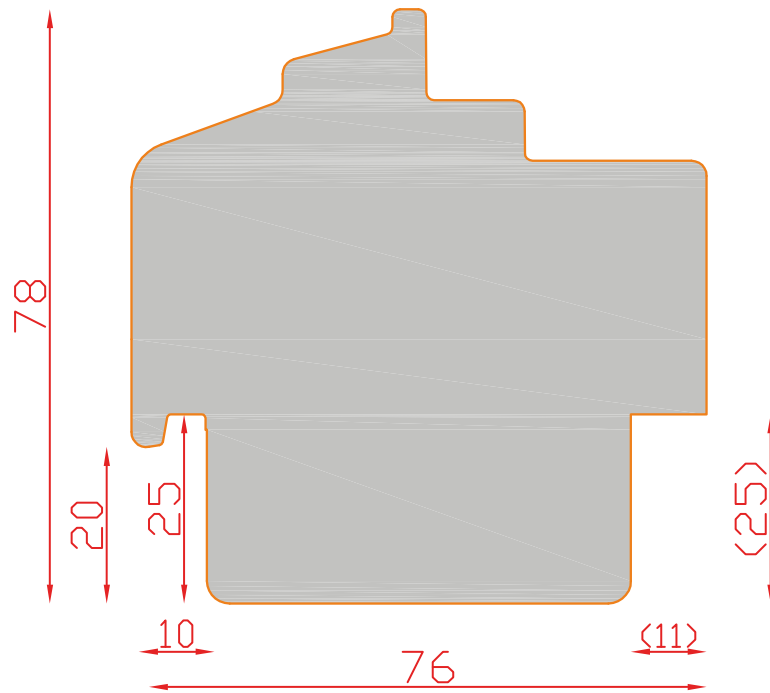

IV76
STANDARD

Schnitt : Vertikal

Typ: Alubankfalz 25mm

| Seite: 30

SCHMIDT VISBEK
Fenster. Türen. Innovationen.

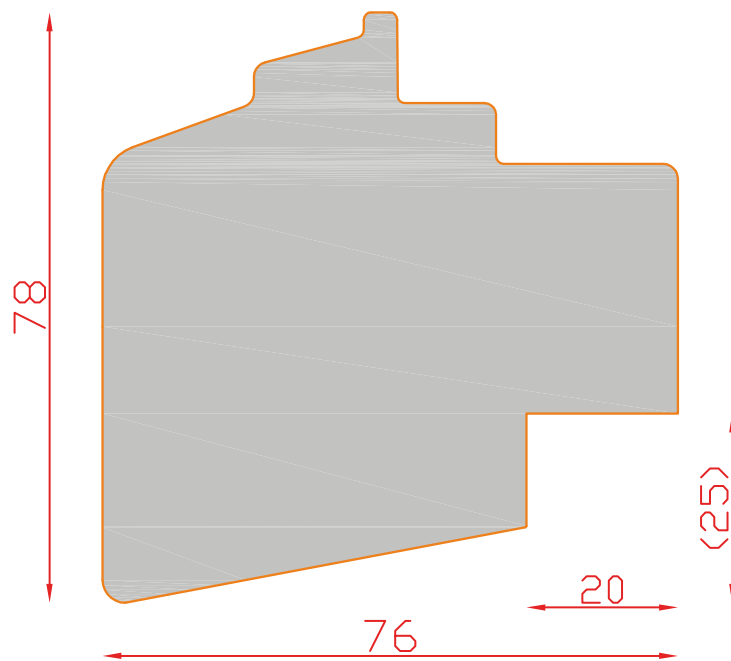

IV76
STANDARD

Schnitt : Vertikal

Typ: Altbauschräge 25mm

| Seite: **31**

SCHMIDT VISBEK
Fenster. Türen. Innovationen.

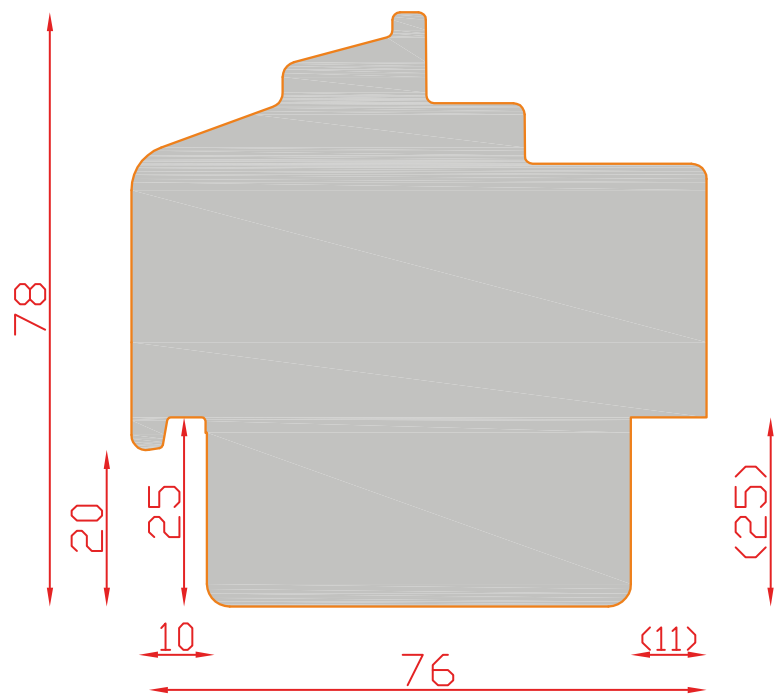

IV76
STANDARD

Schnitt : Vertikal

Typ: Alubankfalz 25mm

| Seite: 32

SCHMIDT VISBEK
Fenster. Türen. Innovationen.

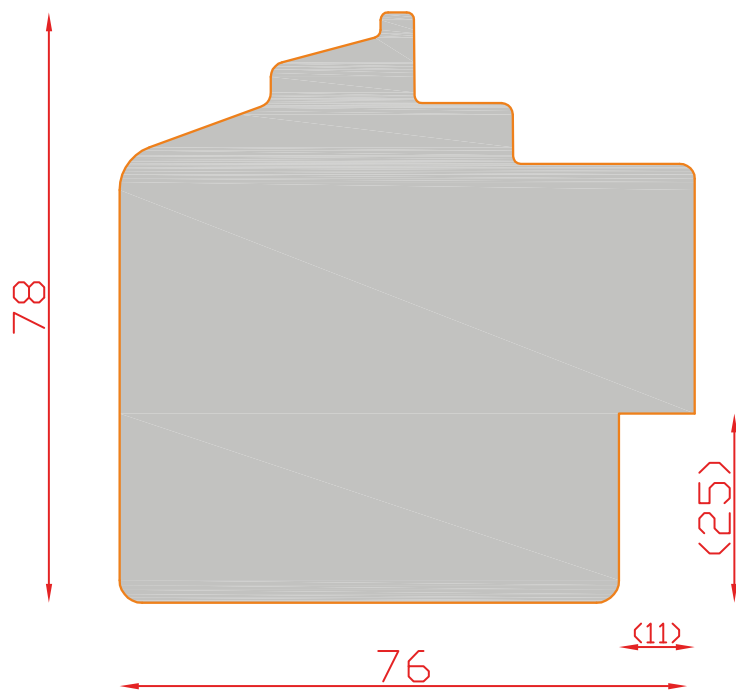

IV76
STANDARD

Schnitt : Vertikal

Typ: Peinemann 25mm

| Seite: 33

SCHMIDT VISBEK
Fenster. Türen. Innovationen.

IV76

S-PROFIL

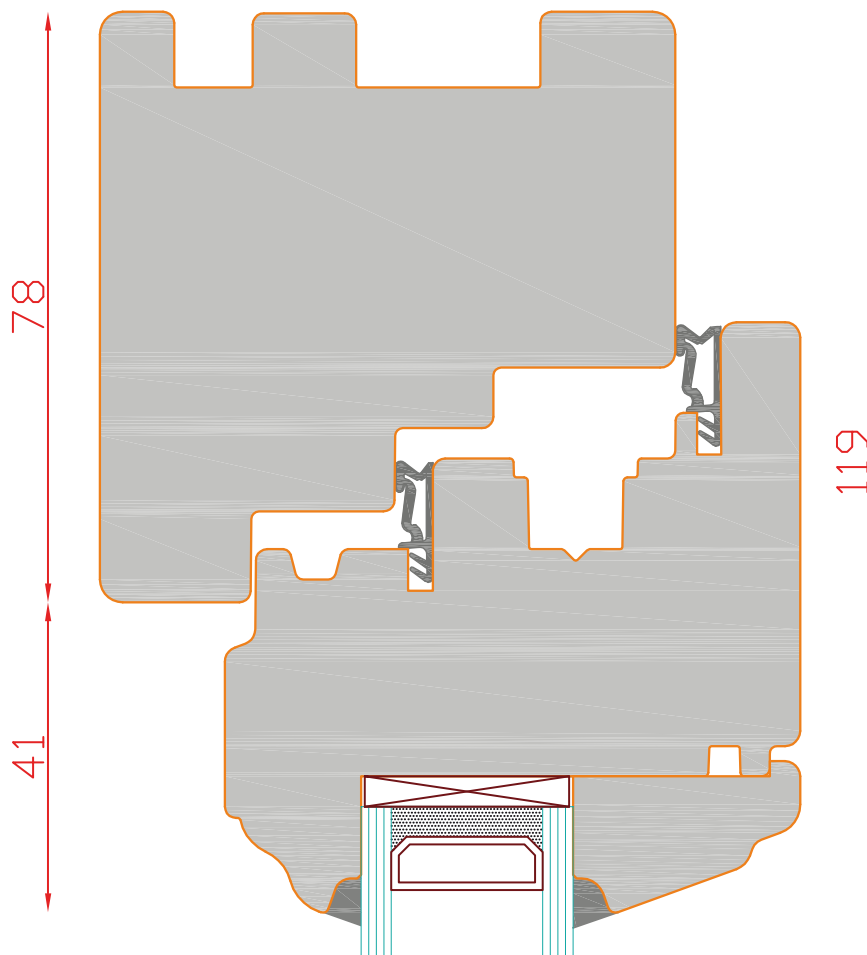
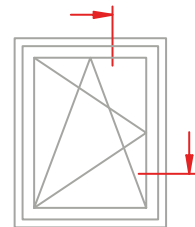

Glasstärken ab
28mm möglich



IV76
S-PROFIL

Schnitt : Vertikal oben und seitlich

Typ: DK

| Seite: 35

SCHMIDT VISBEK
Fenster. Türen. Innovationen.

Glasstärken ab
28mm möglich

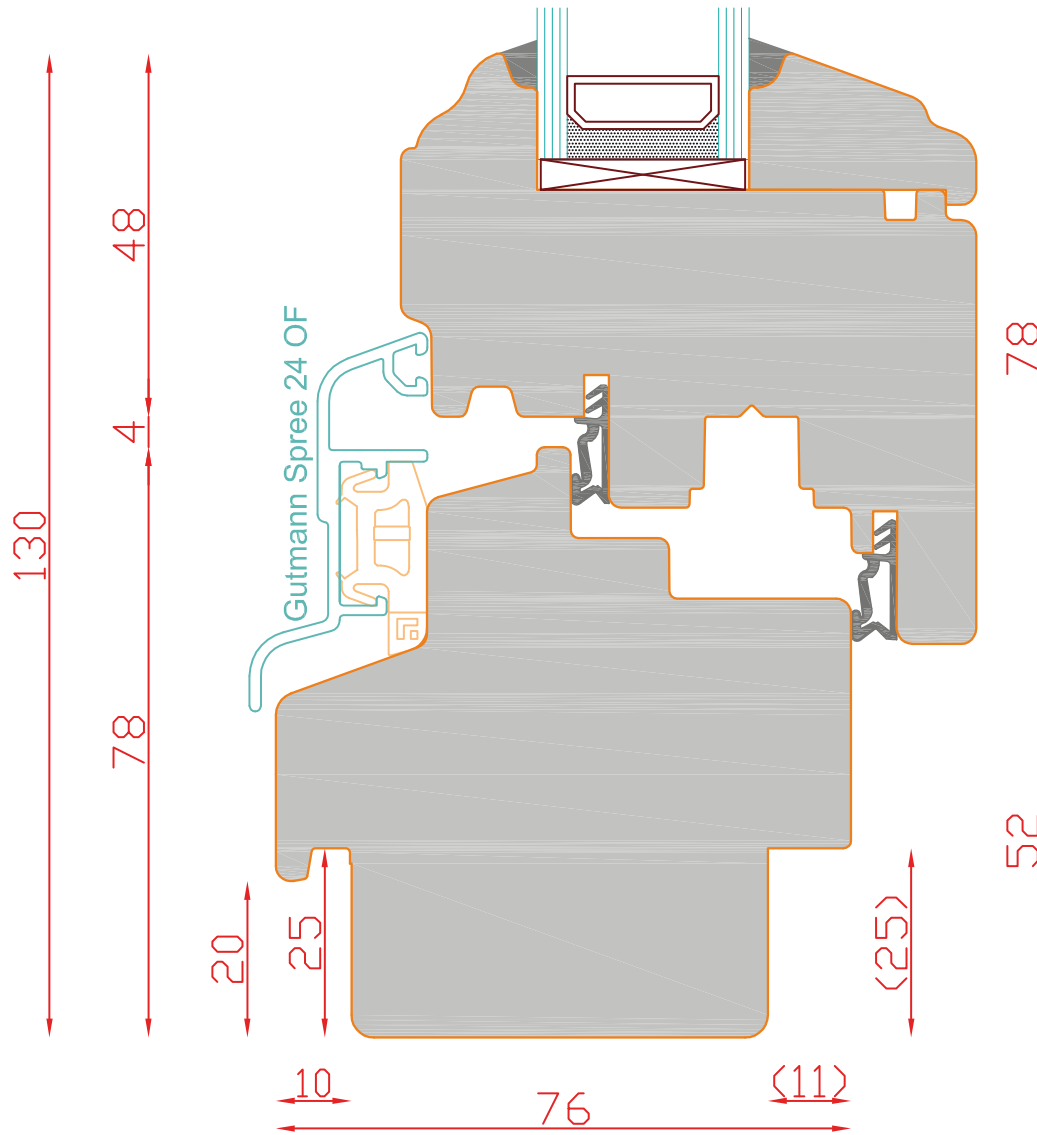
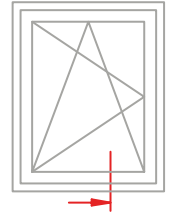

IV76
S-PROFIL

Schnitt : Vertikal unten

Typ: DK / Alu-Regenschiene

Seite: 36



SCHMIDT VISBEK
Fenster. Türen. Innovationen.

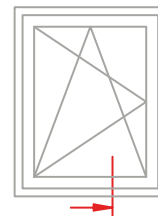

Glasstärken ab
28mm möglich

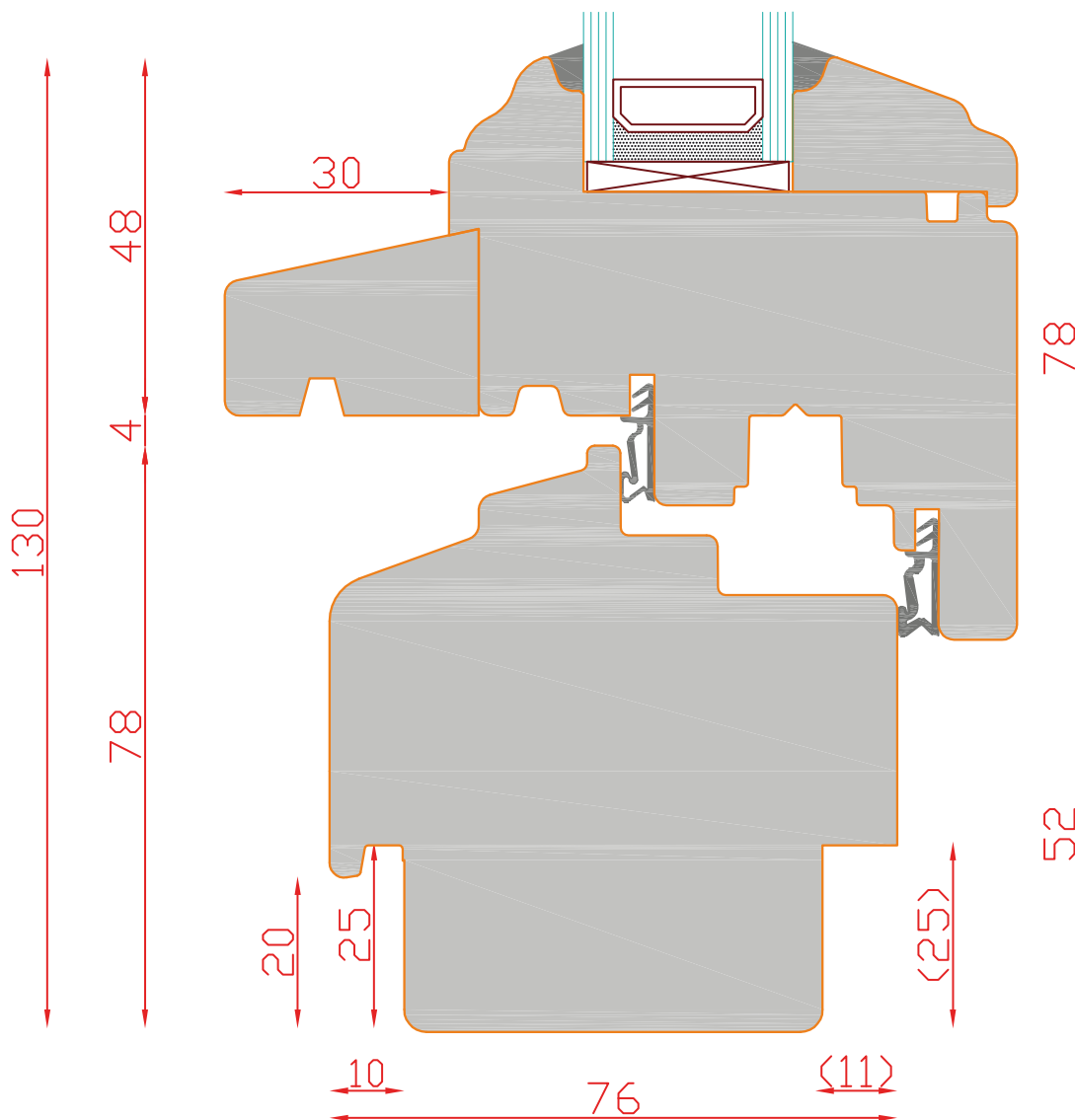

IV76
S-PROFIL

Schnitt : Vertikal unten

Typ: DK / ohne Regenschiene | Seite: 37

SCHMIDT VISBEK
Fenster. Türen. Innovationen.

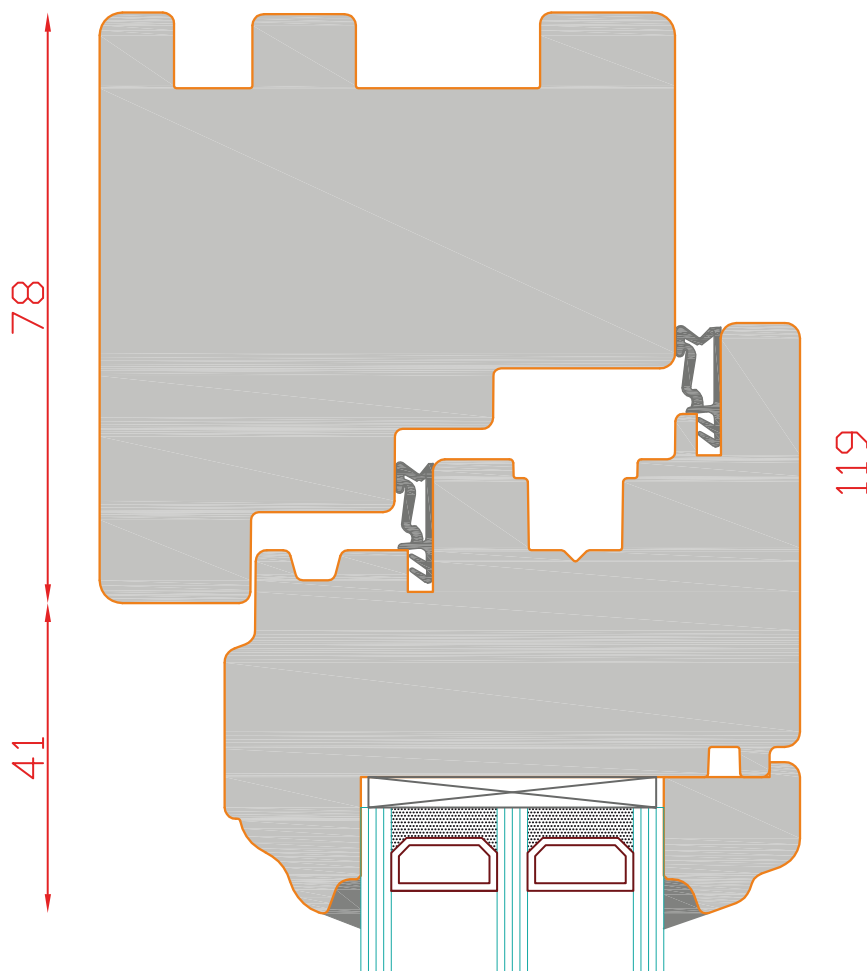
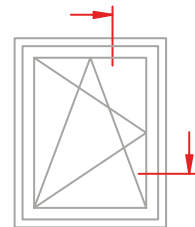

Glasstärken von
32mm-40mm möglich



IV76
S-PROFIL

Schnitt : Vertikal oben und seitlich

Typ: DK

| Seite: 38

SCHMIDT VISBEK
Fenster. Türen. Innovationen.

Glasstärken von
32mm-40mm möglich

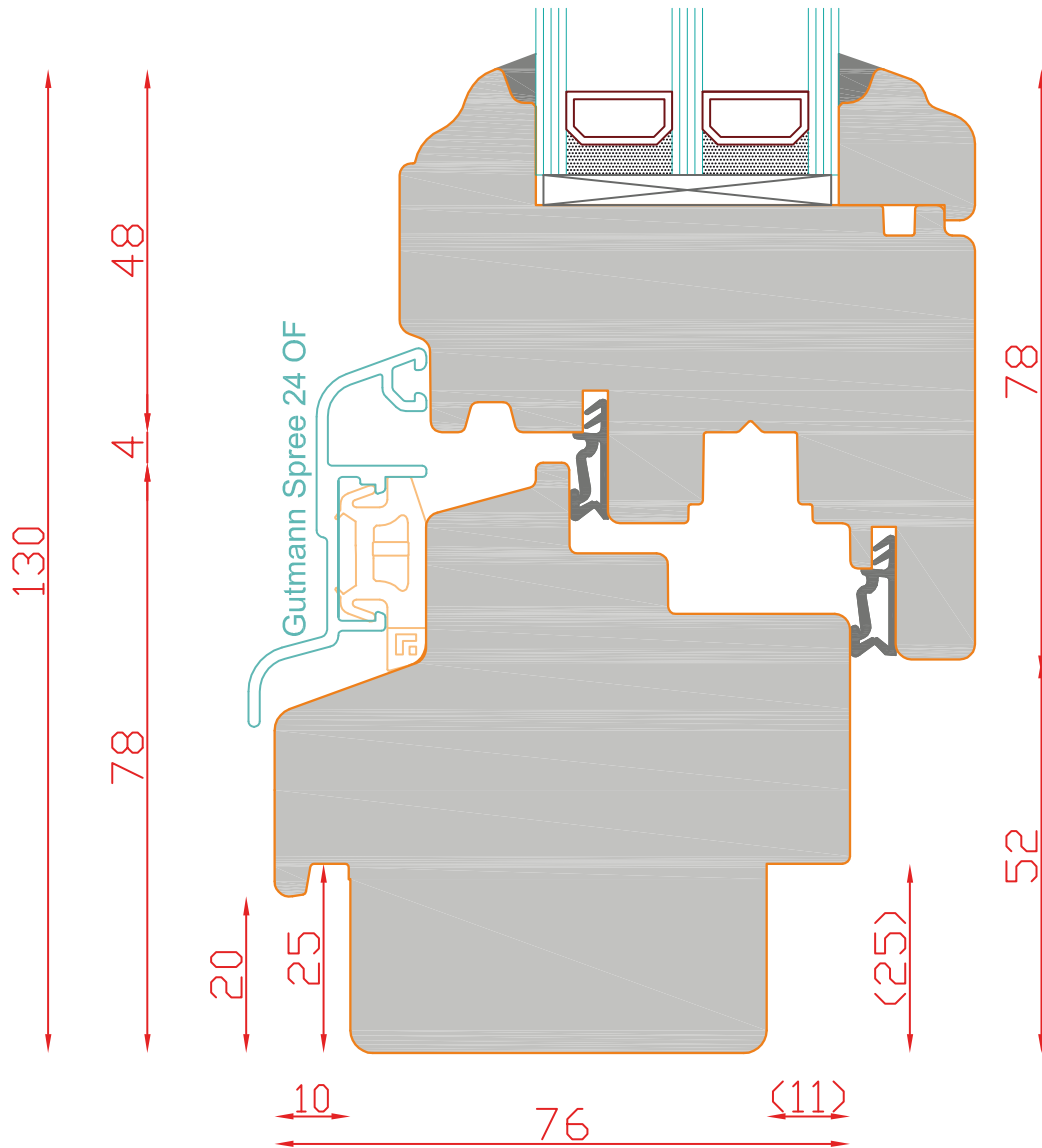
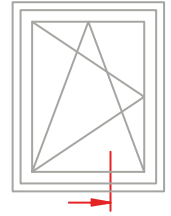

IV76
S-PROFIL

Schnitt : Vertikal unten

Typ: DK / Alu-Regenschiene

Seite: 39

SCHMIDT VISBEK
Fenster. Türen. Innovationen.



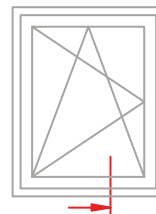

Glasstärken von
32mm-40mm möglich

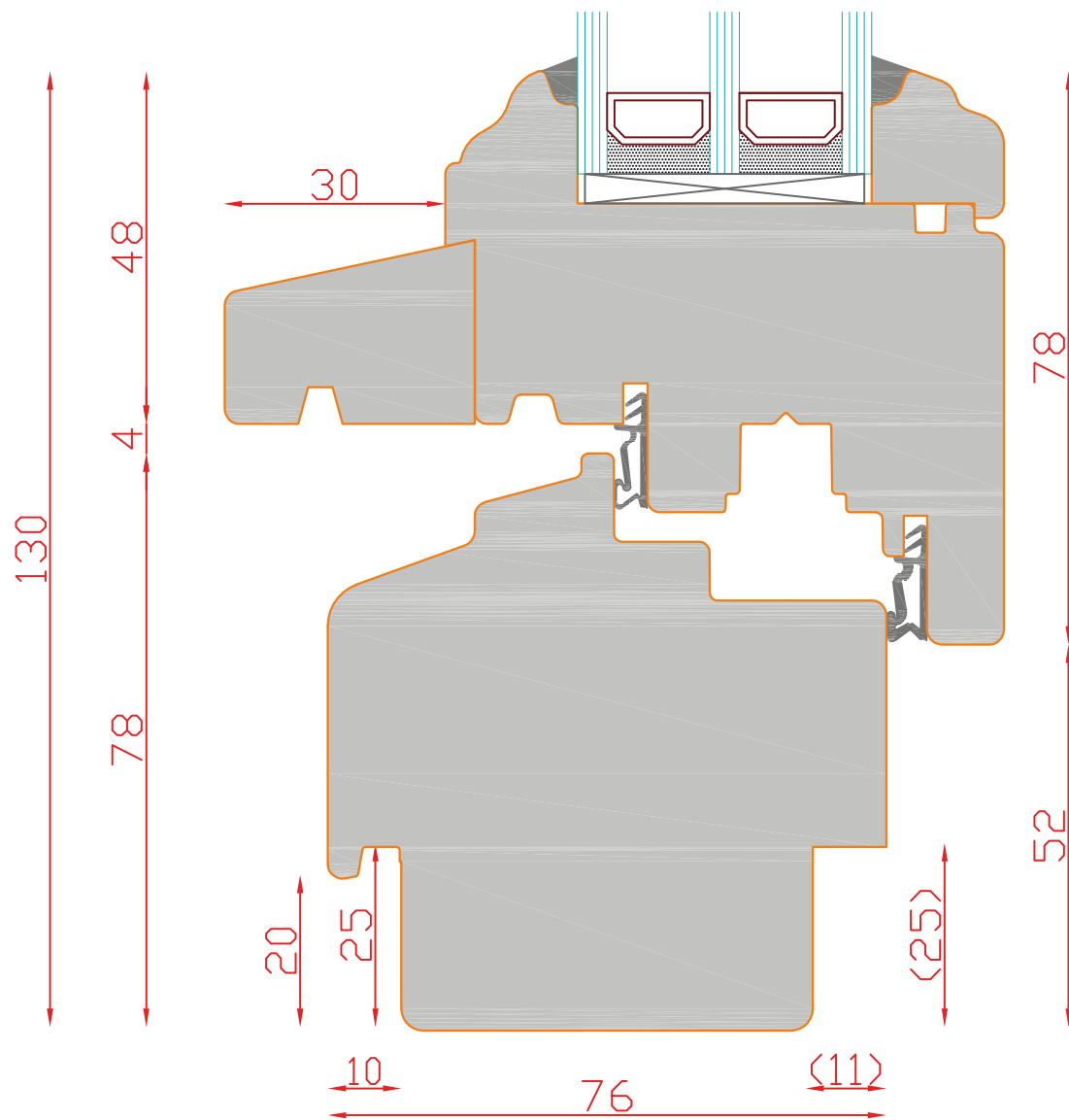

IV76
S-PROFIL

Schnitt : Vertikal unten

Typ: DK / ohne Regenschiene | Seite: 40

SCHMIDT VISBEK
Fenster. Türen. Innovationen.



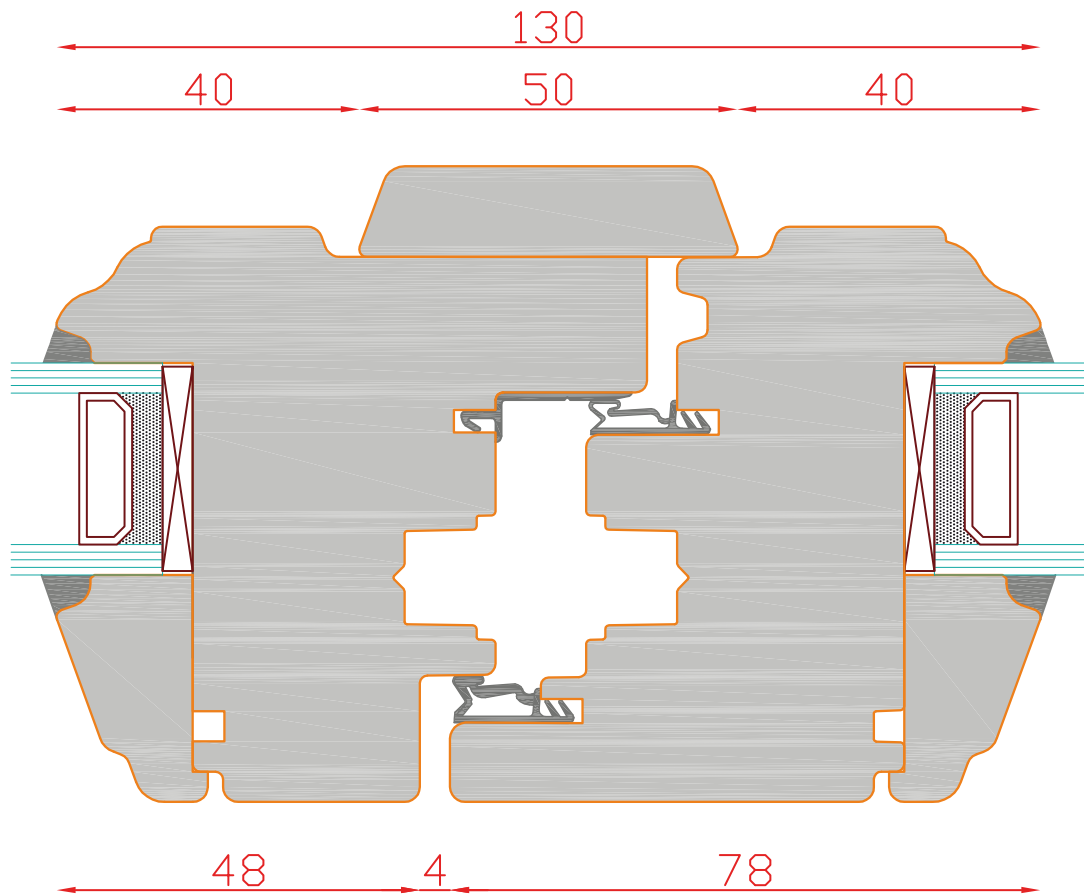
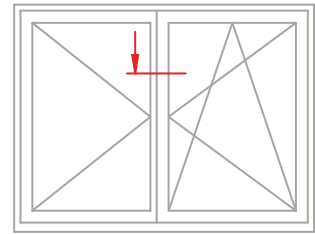

Glasstärken ab
28mm möglich



IV76
S-PROFIL

Schnitt :Horizontal / Stulp

Typ: D - DK / Schlagleiste aufgesetzt | Seite: 41

SCHMIDT VISBEK
Fenster. Türen. Innovationen.

Glasstärken ab
28mm möglich

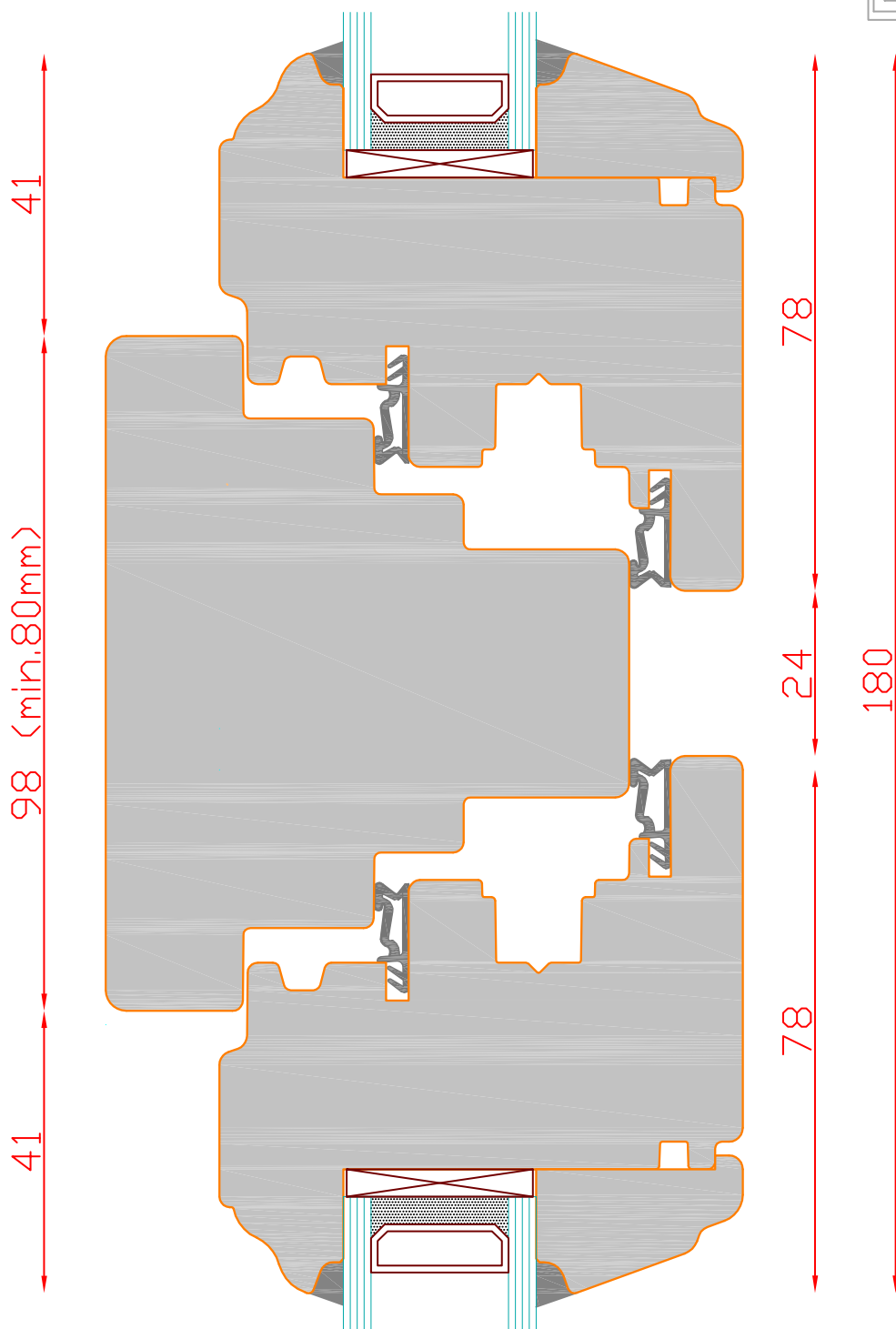
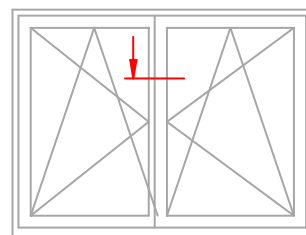

Glasstärken ab
28mm möglich



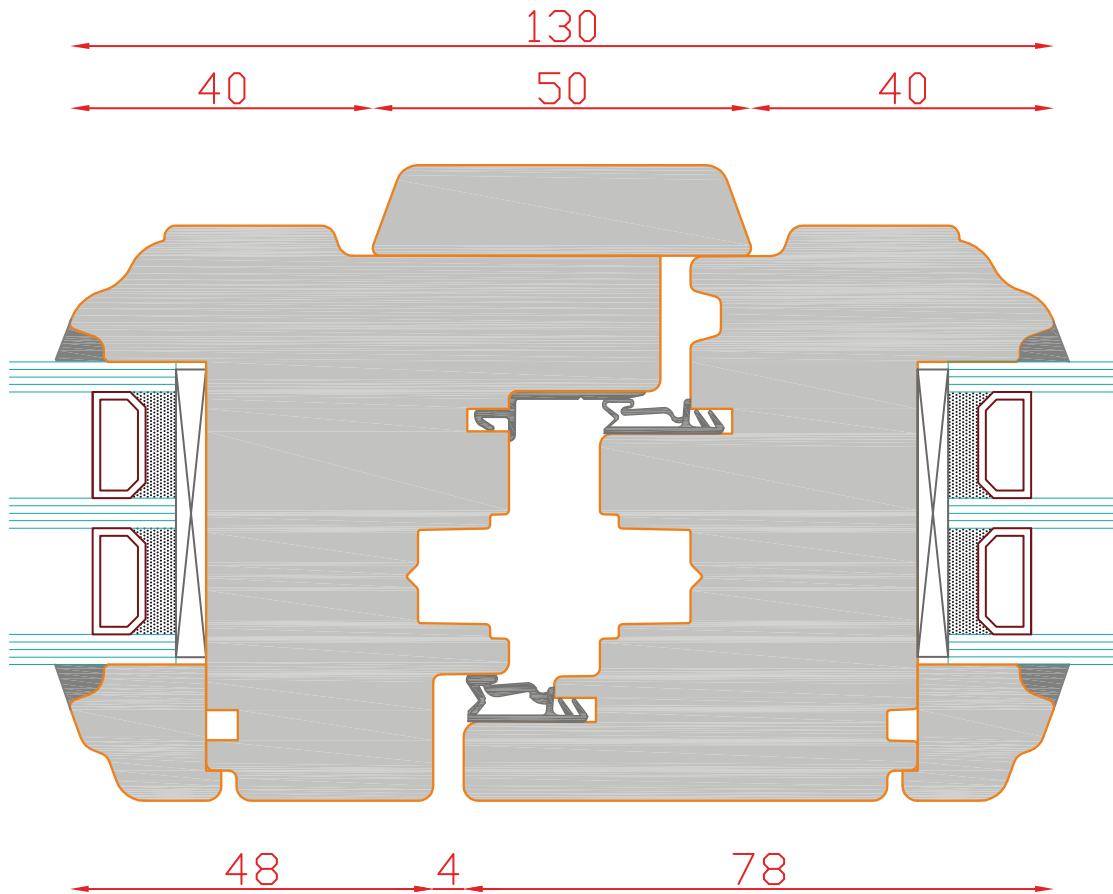
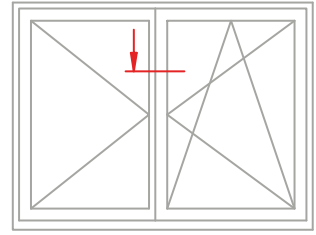

Glasstärken von
32mm-40mm möglich



IV76
S-PROFIL

Schnitt :Horizontal / Stulp

Typ: D - DK / Schlagleiste aufgesetzt | Seite: 43

SCHMIDT VISBEK
Fenster. Türen. Innovationen.

Glasstärken von
32mm-40mm möglich

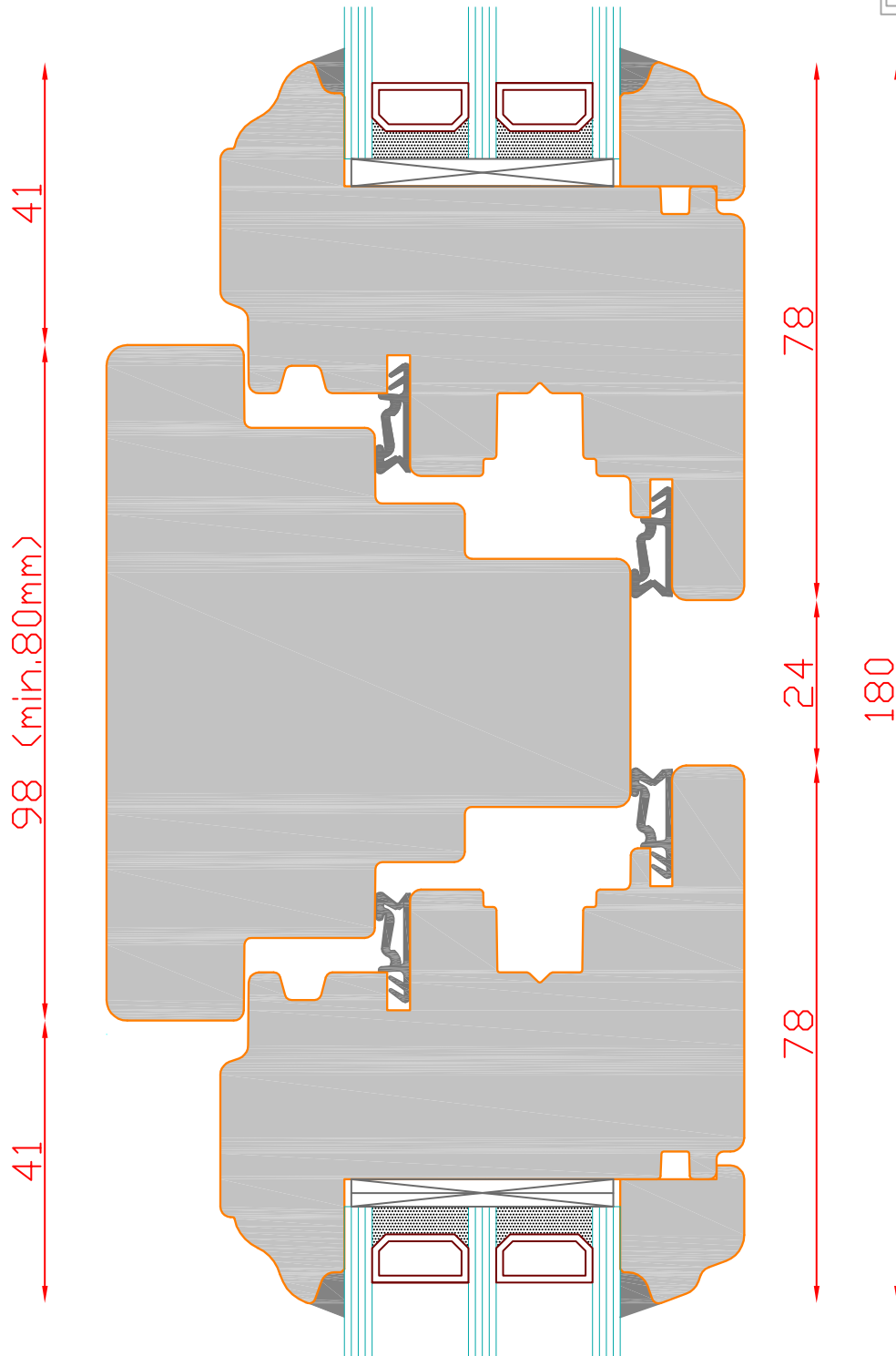
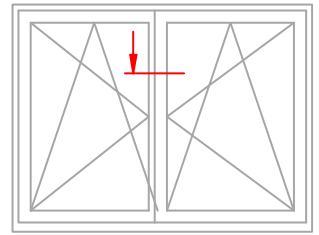

Glasstärken von
32mm-40mm möglich



IV76
S-PROFIL

Schnitt :Horizontal/ Pfosten 100mm

Typ: DK-DK

| Seite: 44

SCHMIDT VISBEK
Fenster. Türen. Innovationen.

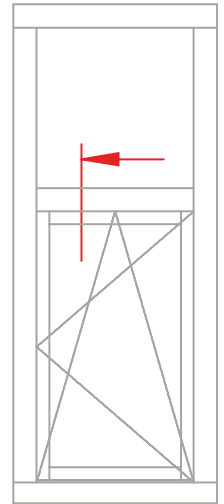

Glasstärken ab
28mm möglich

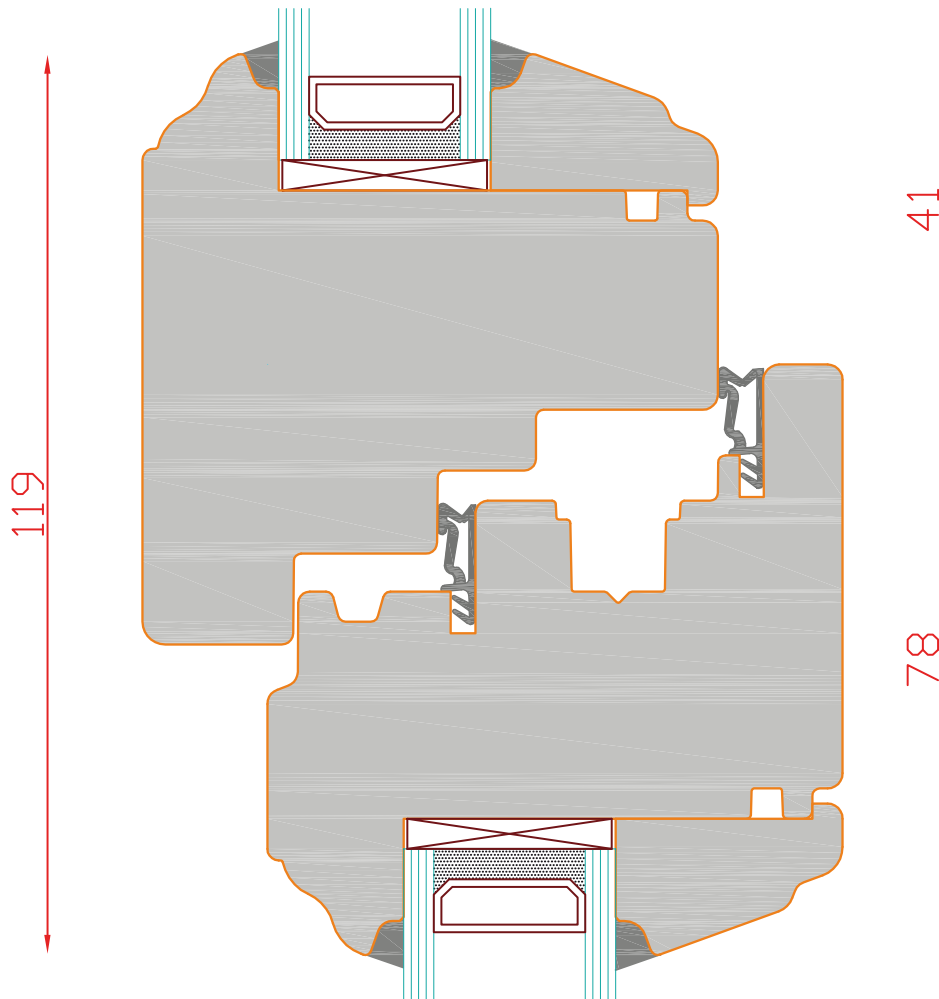

Glasstärken ab
28mm möglich



IV76
S-PROFIL

Schnitt : Vertikal Kämpfersituation

Typ: oben FIB / unten DK

| Seite: 45

SCHMIDT VISBEK
Fenster. Türen. Innovationen.

Glasstärken ab
28mm möglich

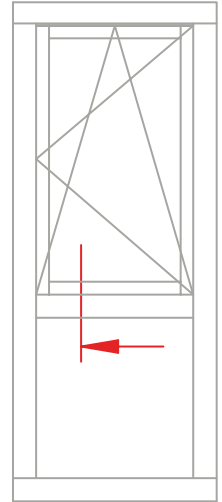
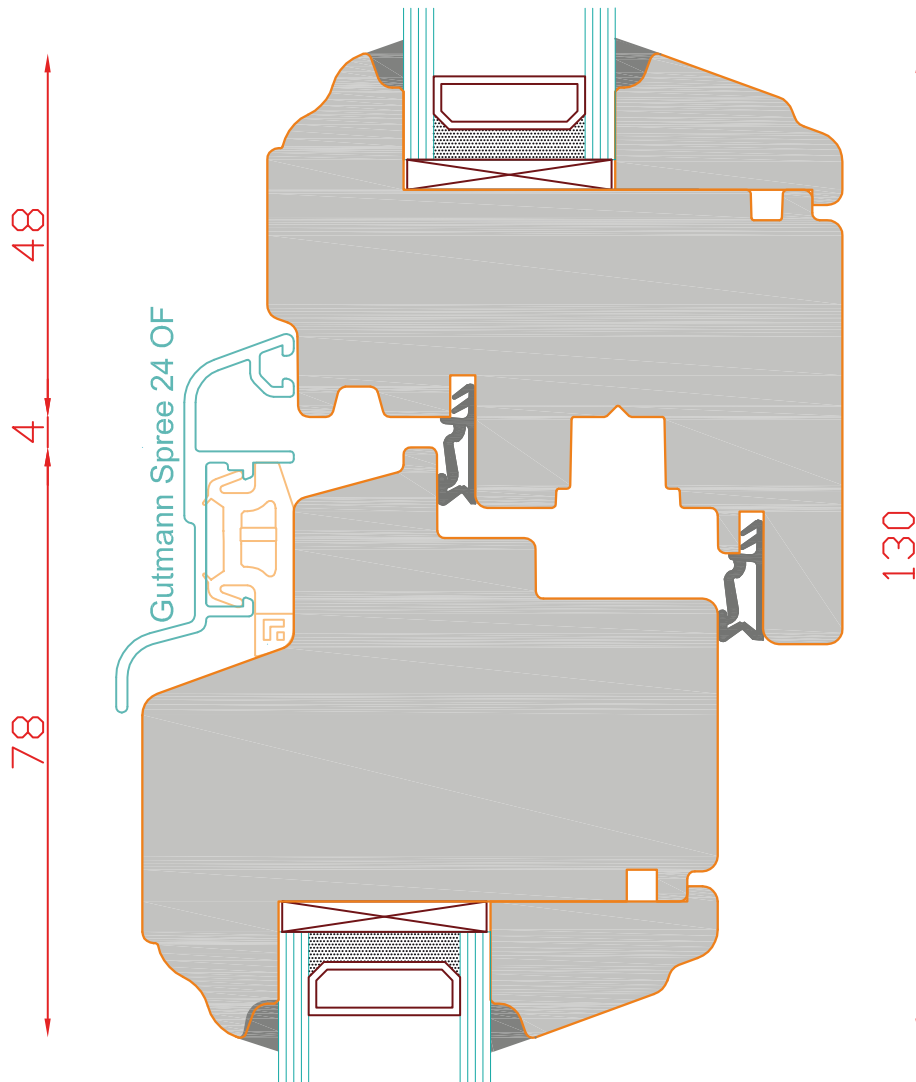

Glasstärken ab
28mm möglich



IV76
S-PROFIL

Schnitt : Vertikal Kämpfersituation

Typ: oben DK / unten FIB

| Seite: 46

SCHMIDT VISBEK
Fenster. Türen. Innovationen.

Glasstärken ab
28mm möglich

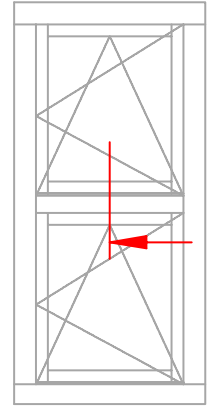
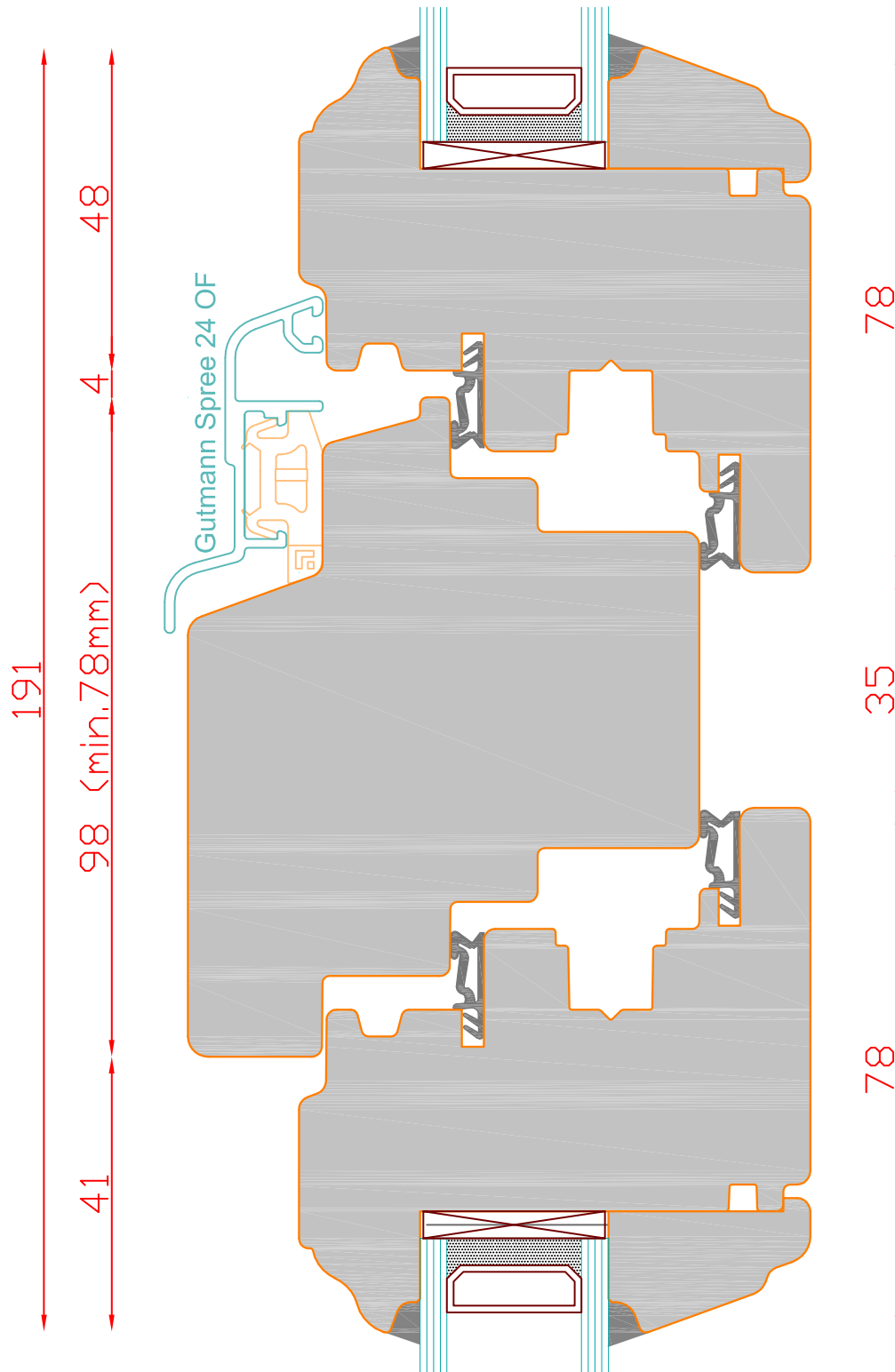

Glasstärken ab
28mm möglich



IV76
S-PROFIL

Schnitt : Vertikal Kämpfersituation

Typ: oben DK / unten DK

| Seite: 47

SCHMIDT VISBEK
Fenster. Türen. Innovationen.

Glasstärken von
32mm-40mm möglich

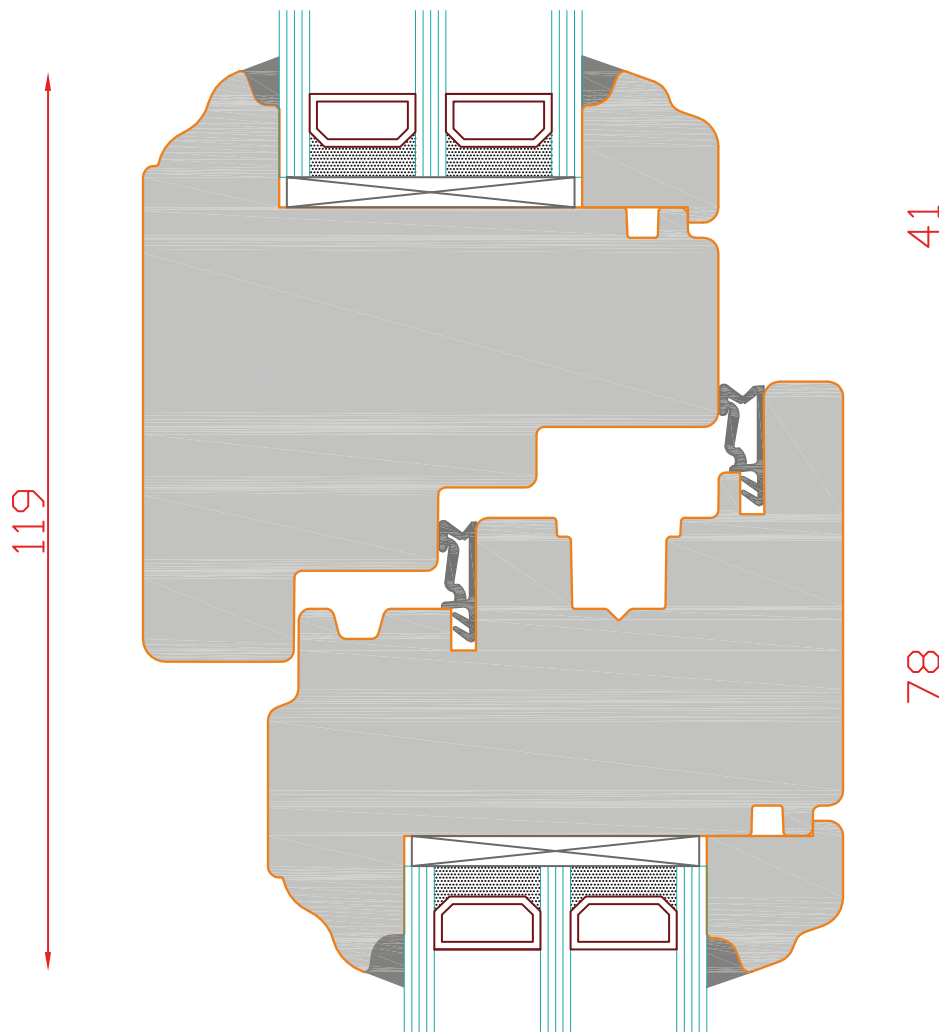
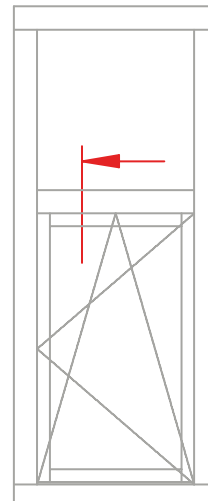

Glasstärken von
32mm-40mm möglich



IV76
S-PROFIL

Schnitt : Vertikal Kämpfersituation

Typ: oben FIB / unten DK

Seite: 48

SCHMIDT VISBEK
Fenster. Türen. Innovationen.

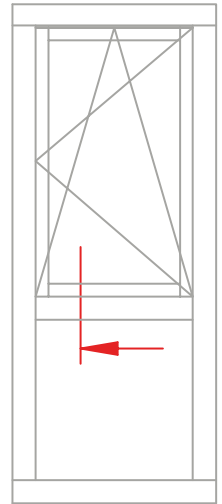

Glasstärken von
32mm-40mm möglich

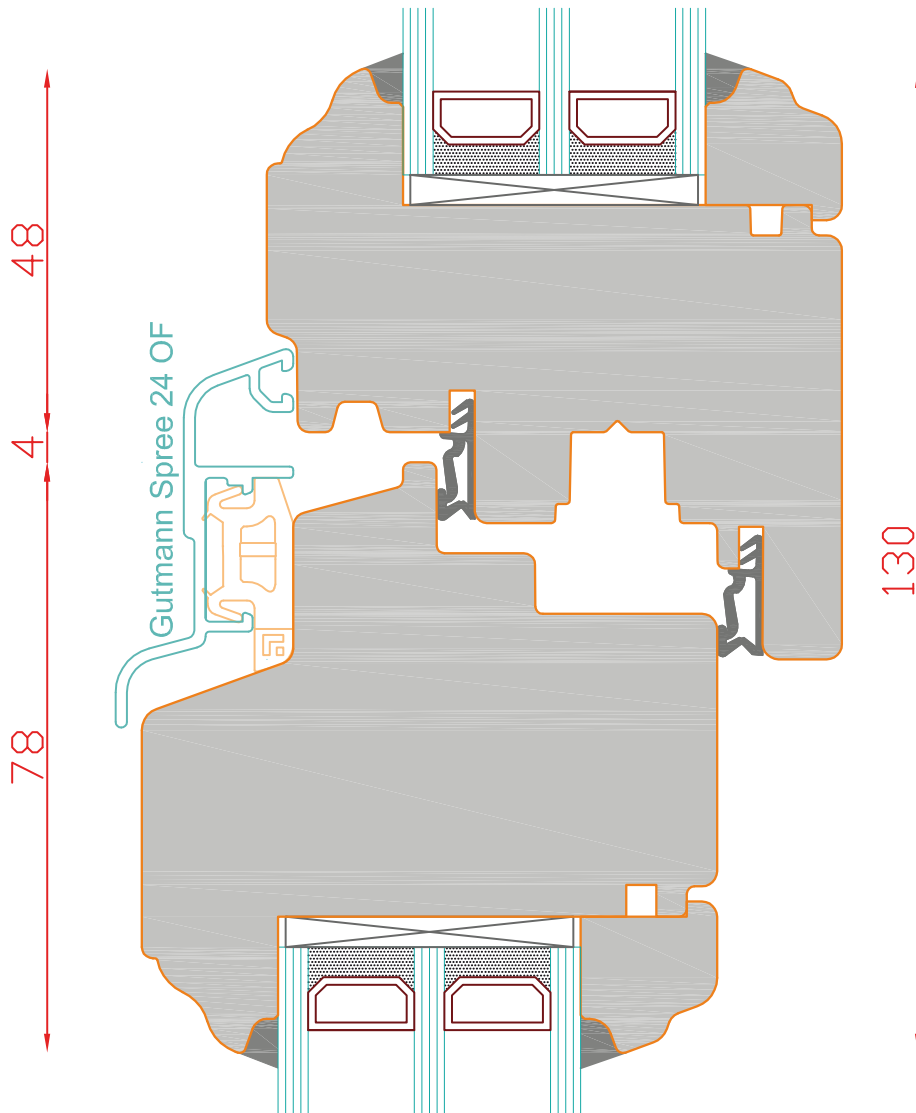

Glasstärken von
32mm-40mm möglich



Glasstärken von
32mm-40mm möglich

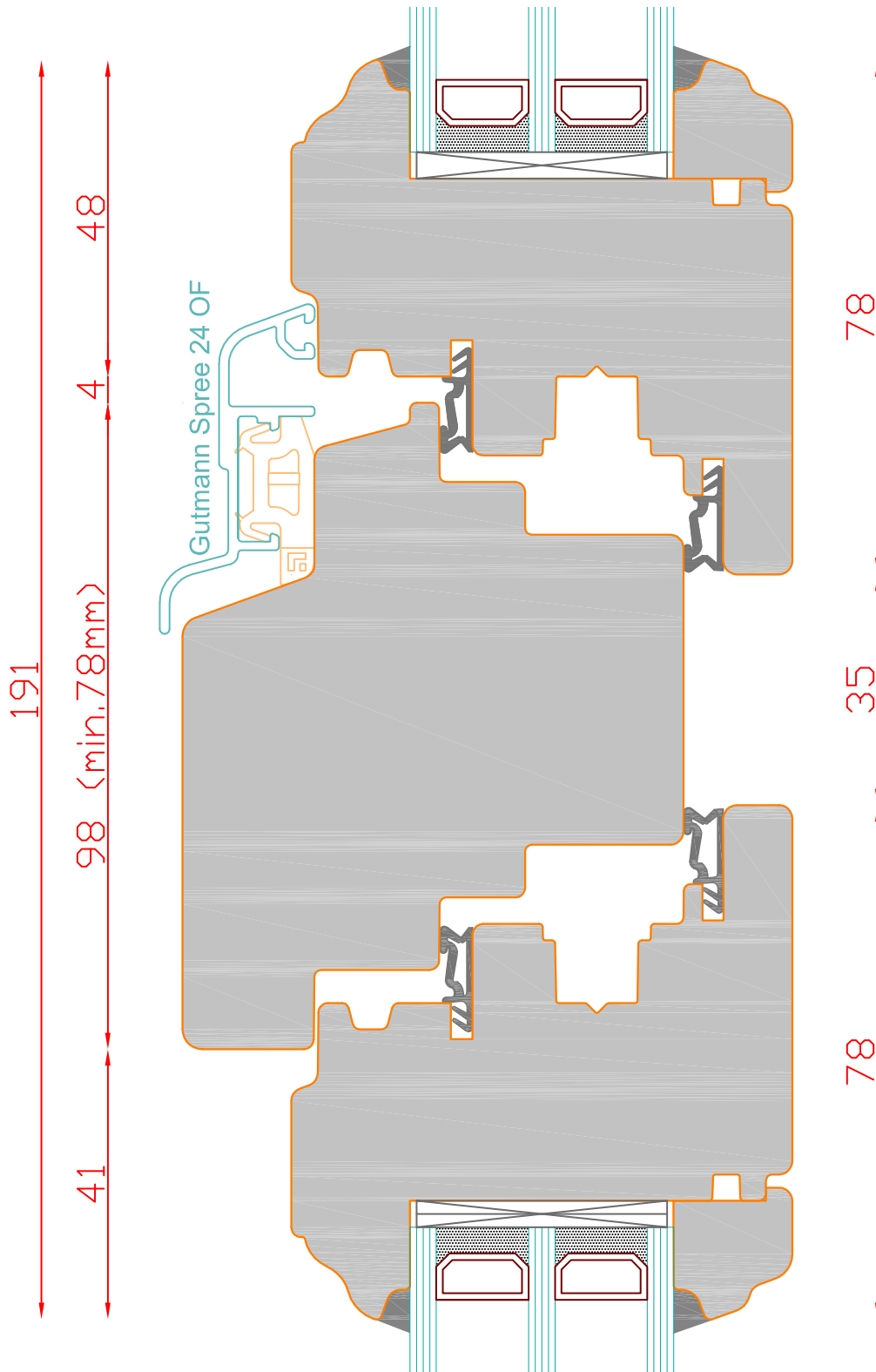
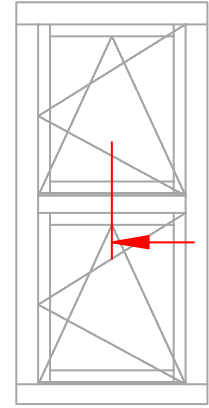

Glasstärken von
32mm-40mm möglich



IV76
S-PROFIL

Schnitt : Vertikal Kämpfersituation

Typ: oben DK / unten DK

Seite: 50

SCHMIDT VISBEK
Fenster. Türen. Innovationen.

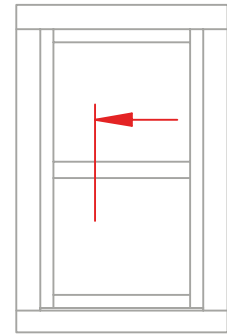

Glasstärken ab
28mm möglich

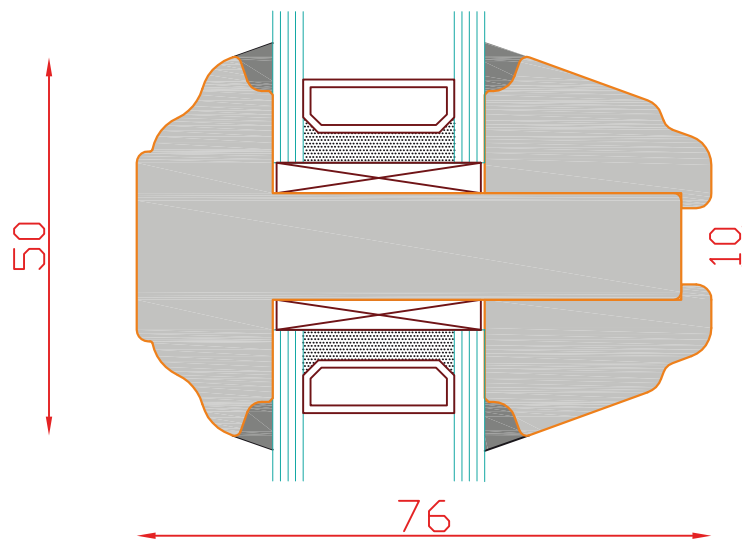

IV76
S-PROFIL

Schnitt : Vertikal 50mm Sprosse

Typ: Konter/Dübel

| Seite: 51

SCHMIDT VISBEK
Fenster. Türen. Innovationen.

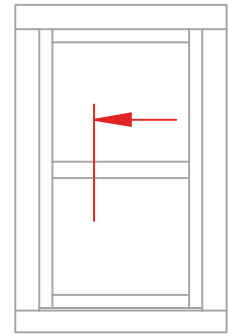

Glasstärken ab
28mm möglich

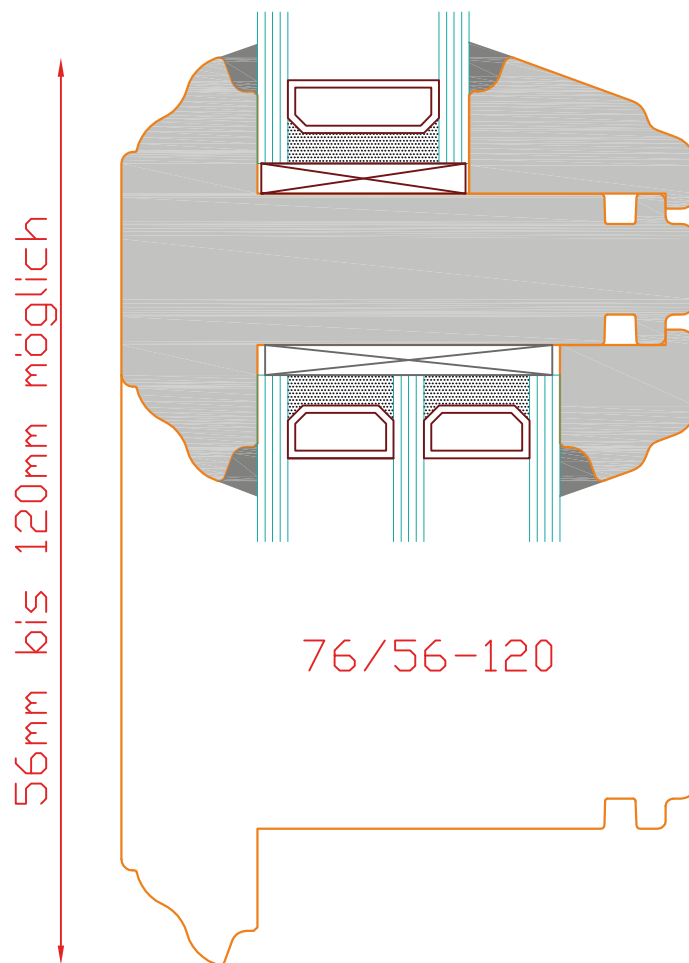

IV76
S-PROFIL

Schnitt : Vertikal 56-120mm Sprosse

Typ: Konter/Dübel

| Seite: 52

SCHMIDT VISBEK
Fenster. Türen. Innovationen.

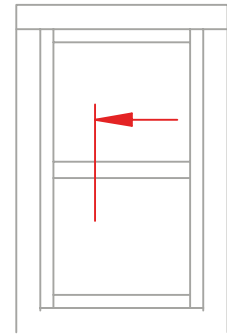

Glasstärken von
32mm-40mm möglich

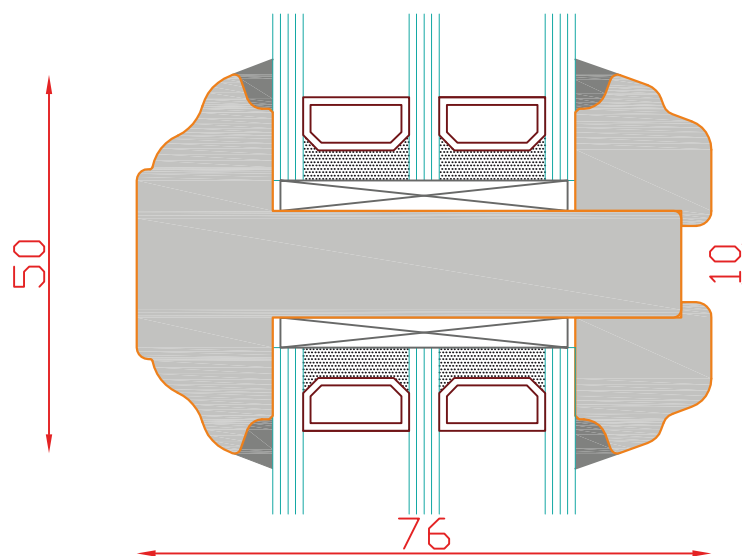

IV76
S-PROFIL

Schnitt : Vertikal 50mm Sprosse

Typ: Konter/Dübel

| Seite: 53

SCHMIDT VISBEK
Fenster. Türen. Innovationen.

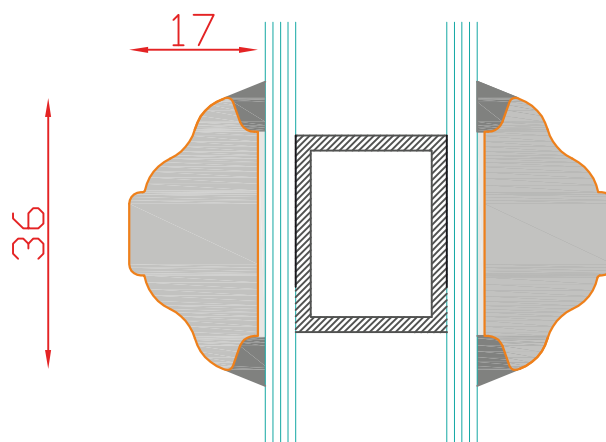
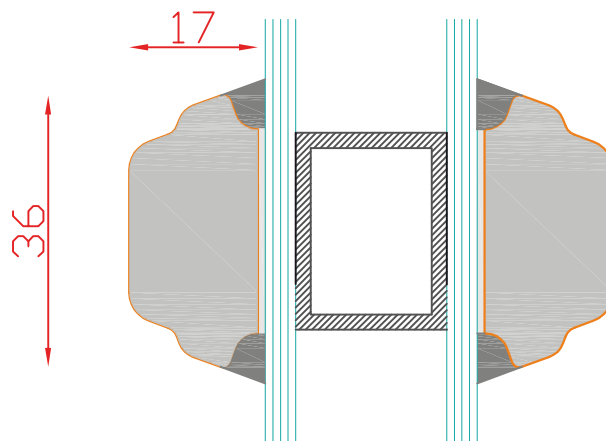
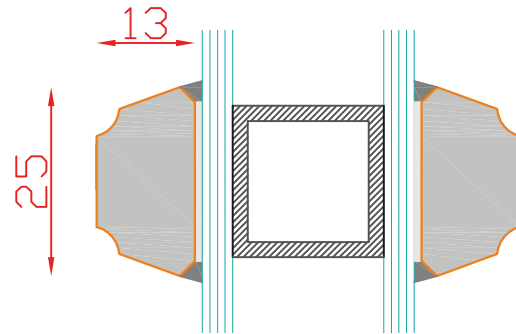
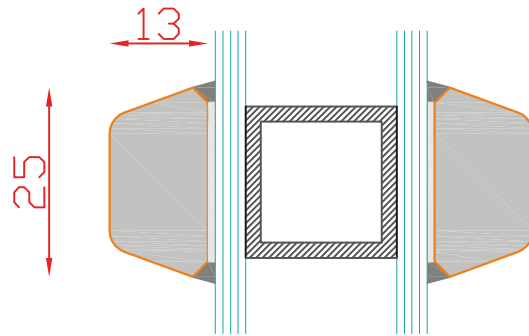
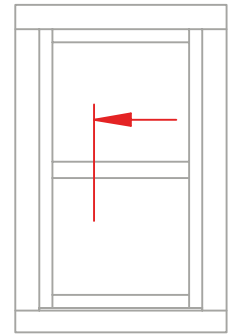

IV76
S-PROFIL

Schnitt : Vertikal

Typ: Sprossen, aufgeklebt

| Seite: 54

SCHMIDT VISBEK
Fenster. Türen. Innovationen.

IV76
schmale
Ausführung

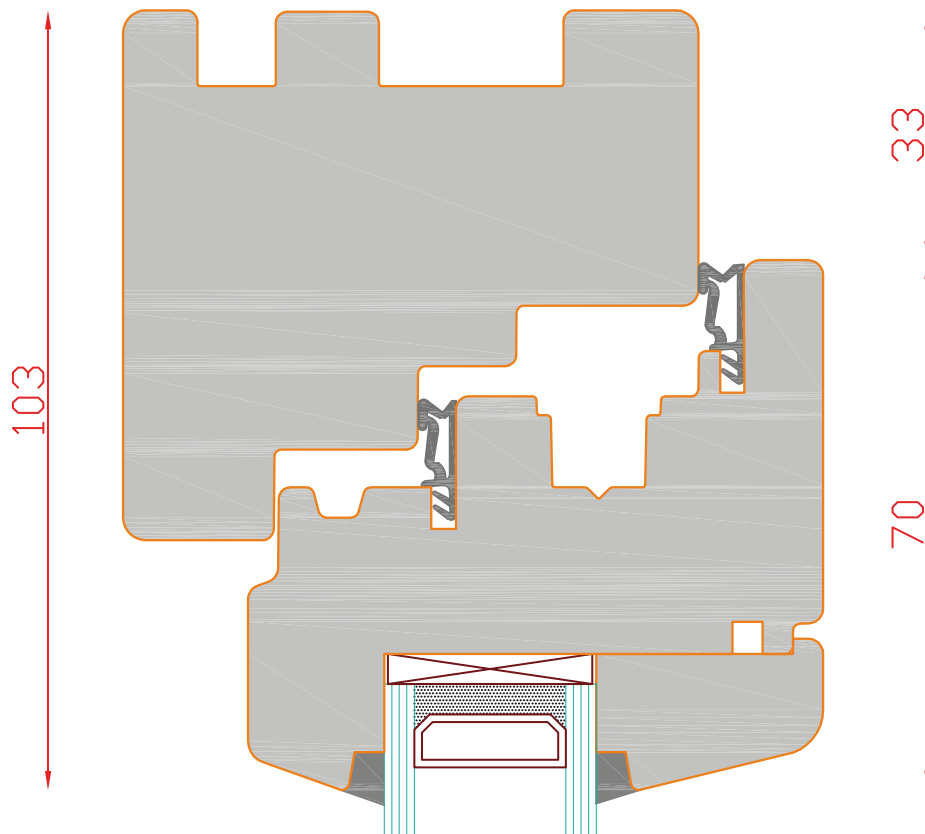
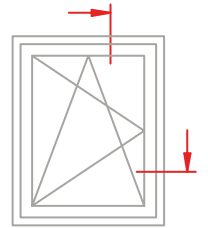

Glasstärken ab
28mm möglich



Glasstärken ab
28mm möglich

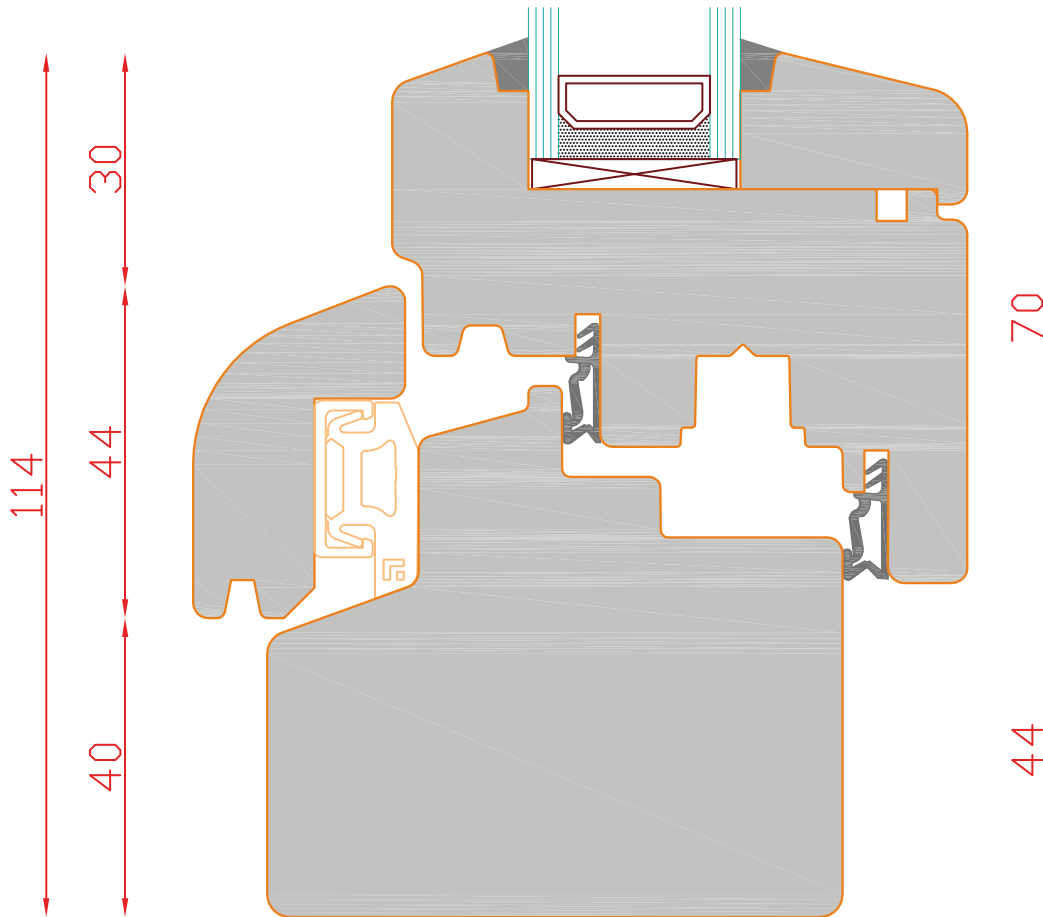
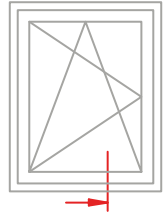

IV76
SCHMALE AUSFÜHRUNG

Schnitt : Vertikal unten

Typ: DK / Holz-Regenschiene | Seite: 57

SCHMIDT VISBEK
Fenster. Türen. Innovationen.

Glasstärken ab
28mm möglich

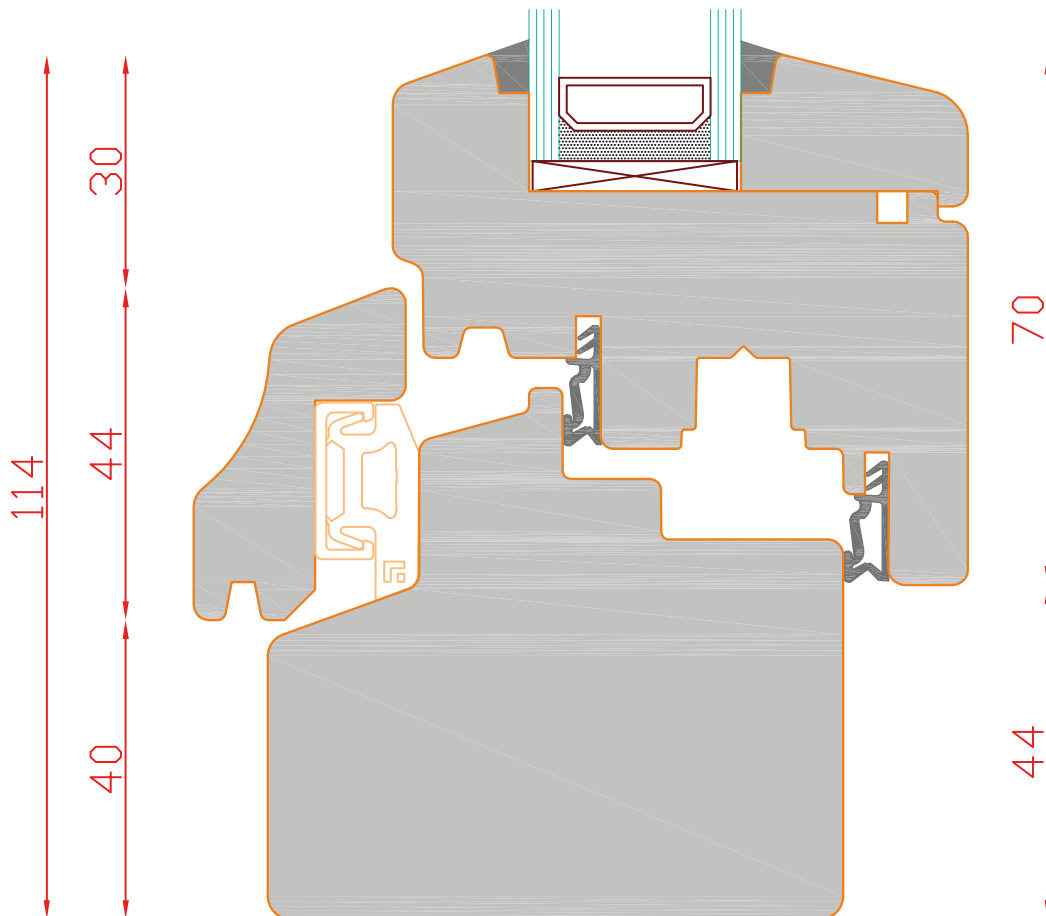
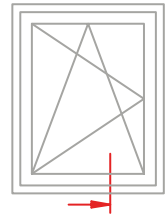

IV76
SCHMALE AUSFÜHRUNG

Schnitt : Vertikal unten

Typ: DK / Holz-Regenschiene | Seite: **58**

SCHMIDT VISBEK
Fenster. Türen. Innovationen.

Glasstärken ab
28mm möglich

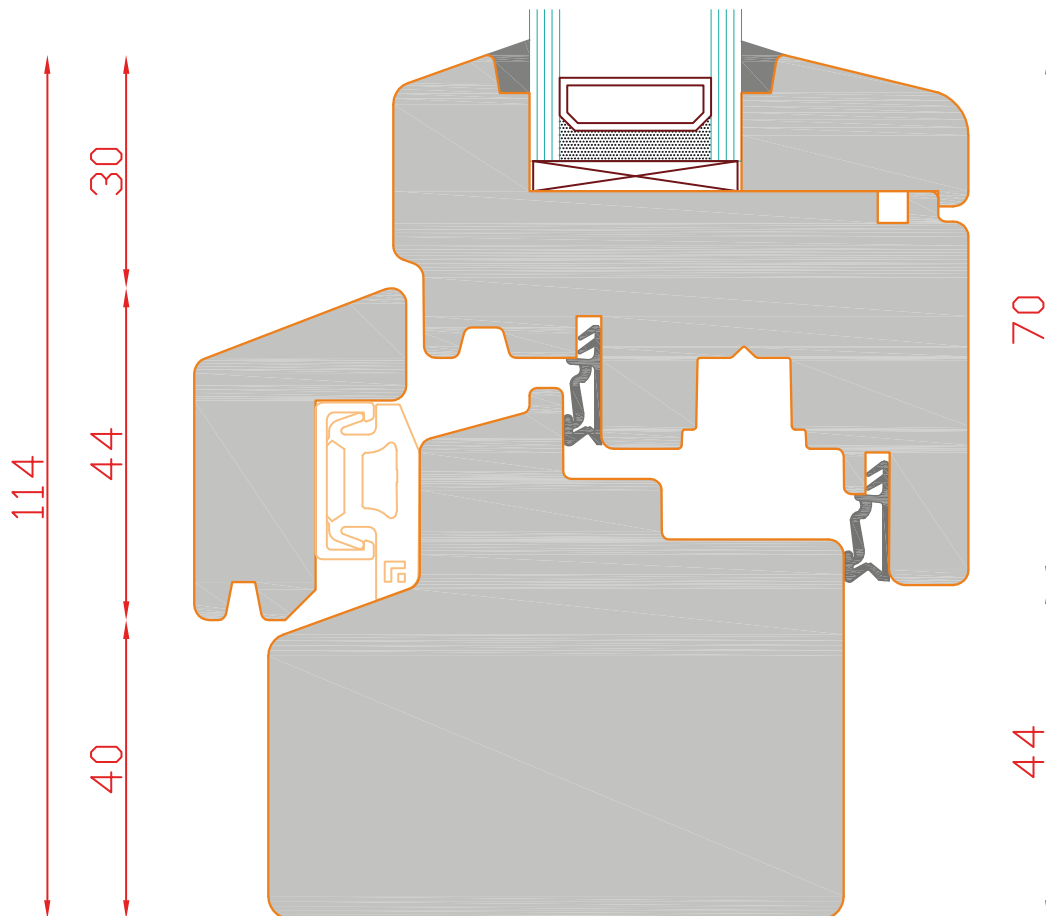
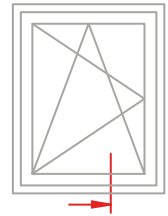

IV76
SCHMALE AUSFÜHRUNG

Schnitt : Vertikal unten

Typ: DK / Holz-Regenschiene | Seite: 59

SCHMIDT VISBEK
Fenster. Türen. Innovationen.

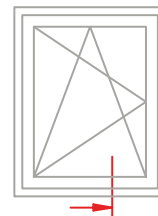

Glasstärken ab
28mm möglich

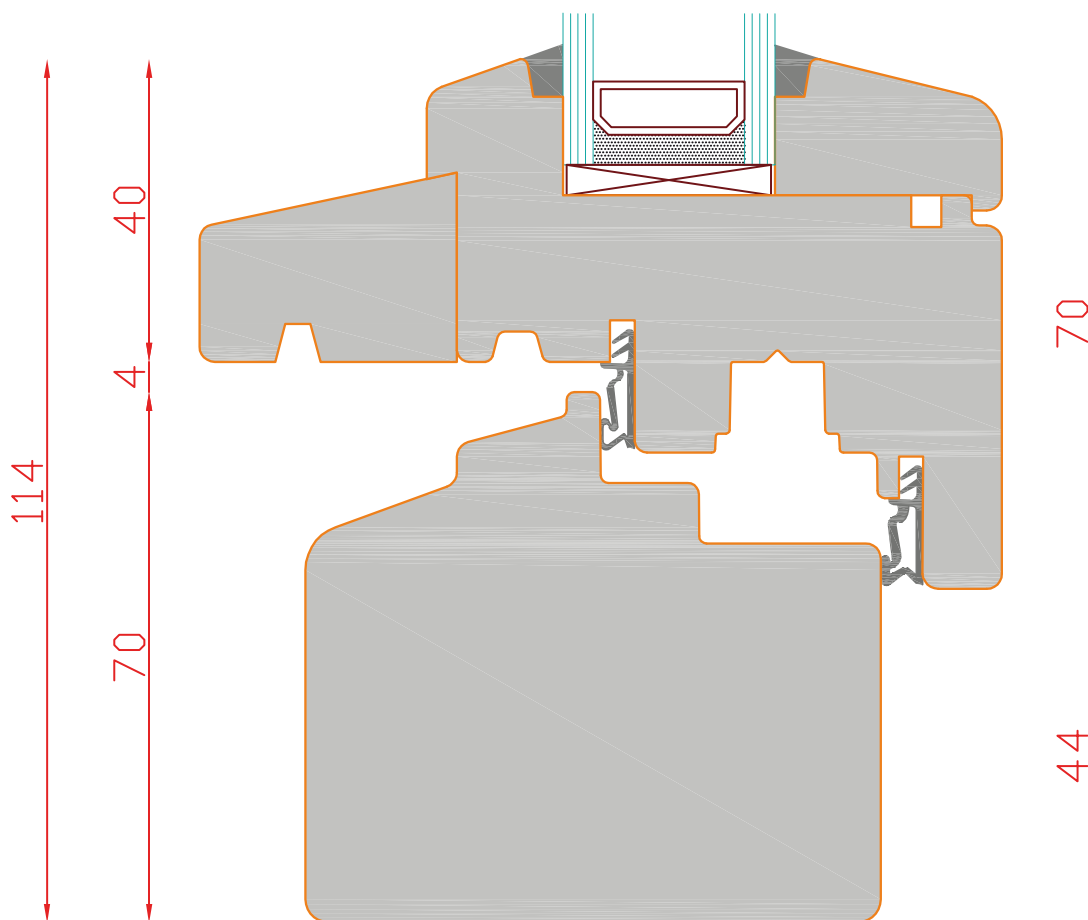

IV76
SCHMALE AUSFÜHRUNG

Schnitt : Vertikal unten

Typ: DK / ohne Regenschiene | Seite: 60

SCHMIDT VISBEK
Fenster. Türen. Innovationen.

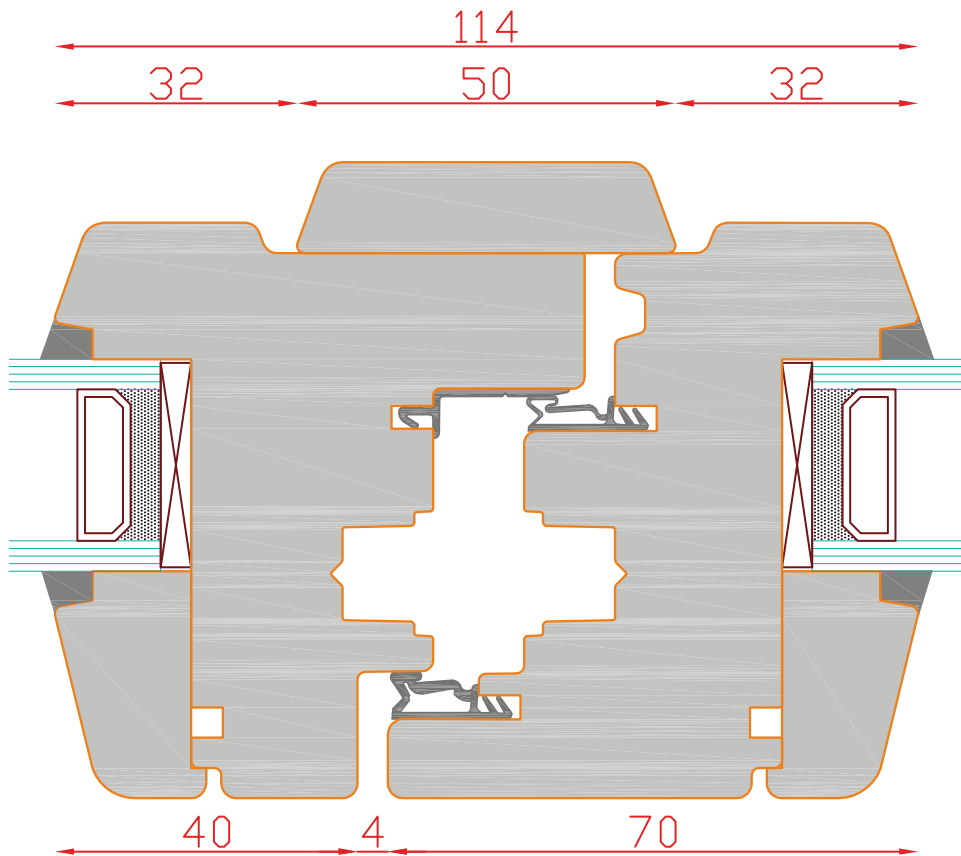
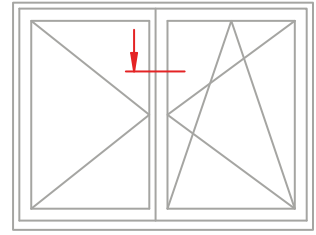

Glasstärken ab
28mm möglich



IV76
SCHMALE AUSFÜHRUNG

Schnitt :Horizontal / Stulp

Typ: D - DK / Schlagleiste aufgesetzt | Seite: **61**

SCHMIDT VISBEK
Fenster. Türen. Innovationen.

IV76

Holzfenstertür

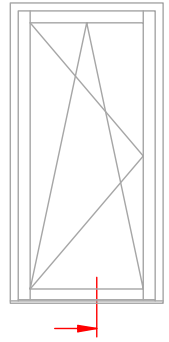

Glasstärken ab
28mm möglich

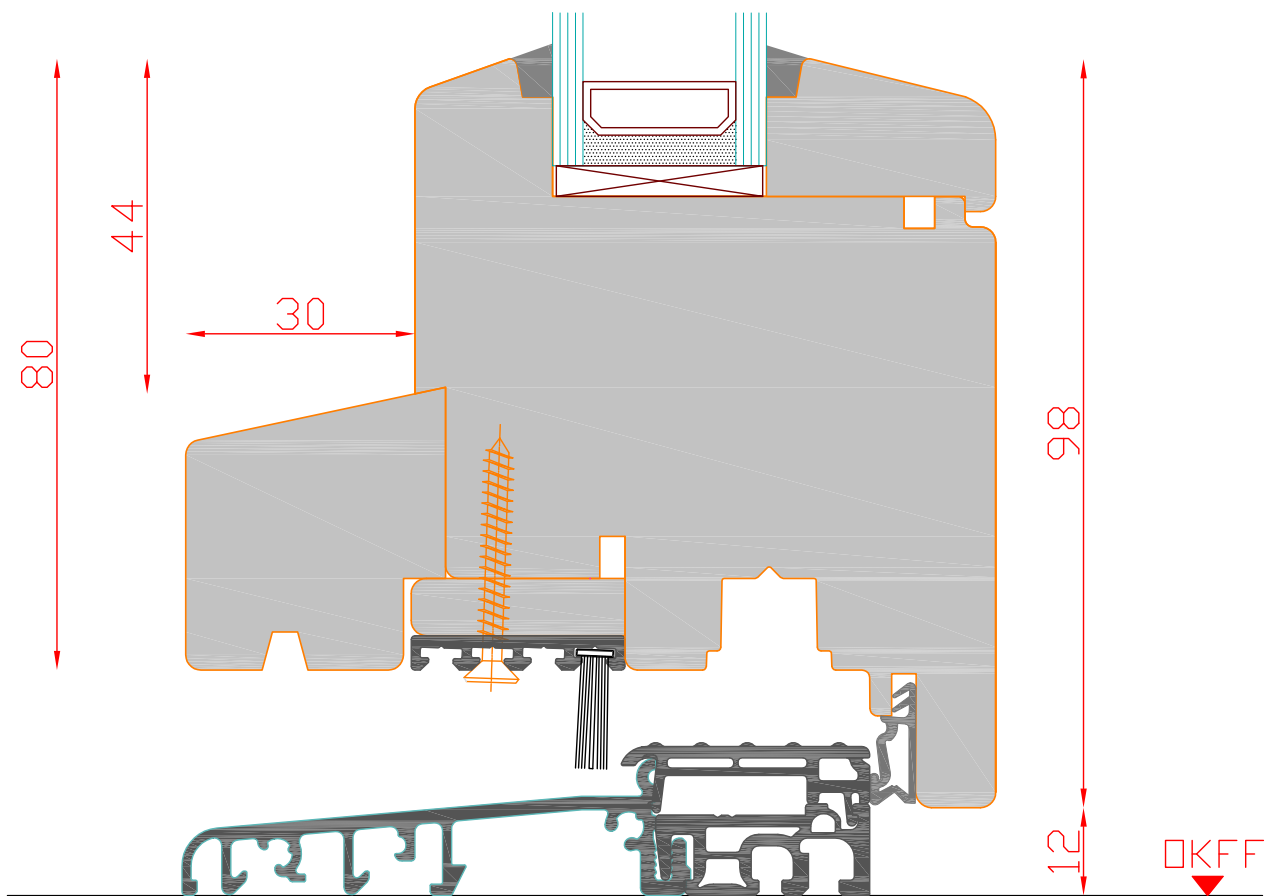

Bodenschwelle BKV Eifel 90 TB



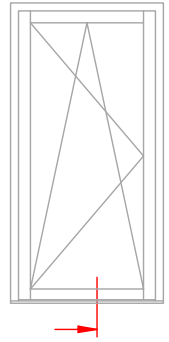

Glasstärken ab
28mm möglich

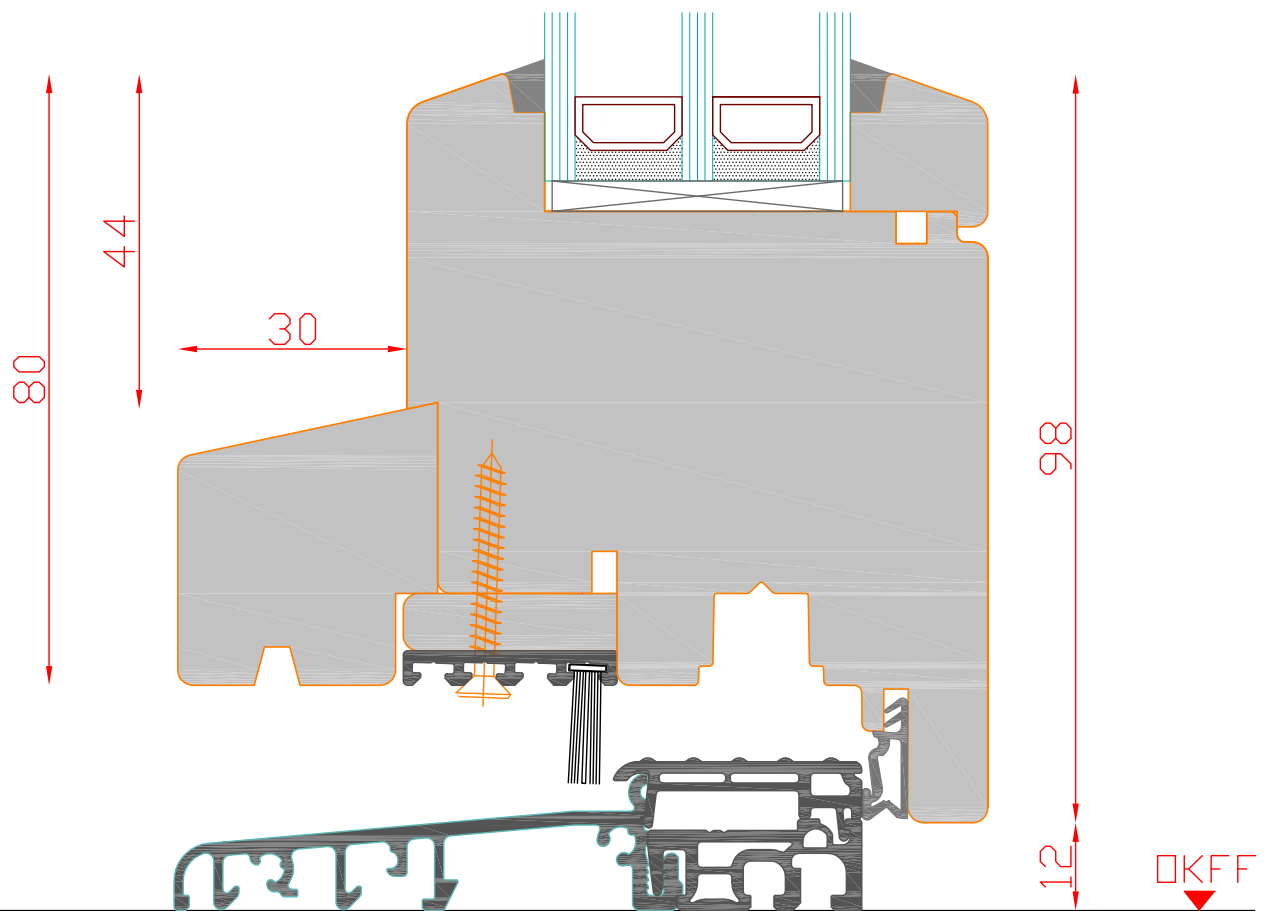

Bodenschwelle BKV Eifel 90 TB



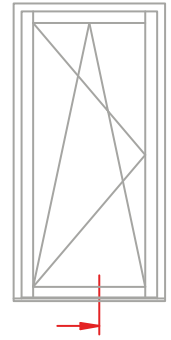

Glasstärken ab
28mm möglich

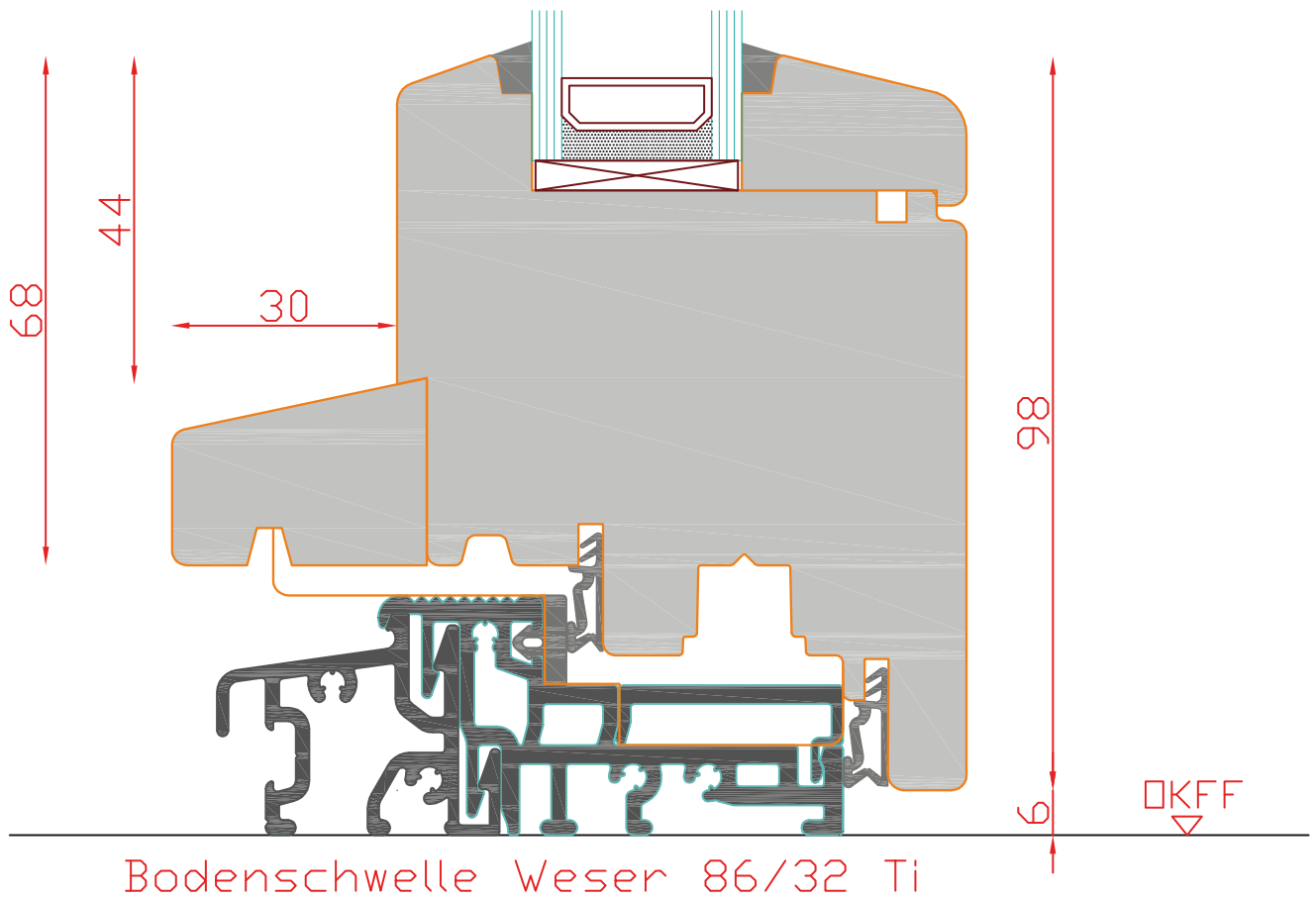

IV76
HOLZFENSTERTÜR

Schnitt : Vertikal unten

Fenstertür Bodenschwelle 32mm | Seite: 65

SCHMIDT VISBEK
Fenster. Türen. Innovationen.



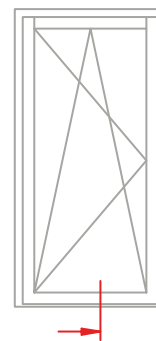

Glasstärken von
32mm-40mm möglich

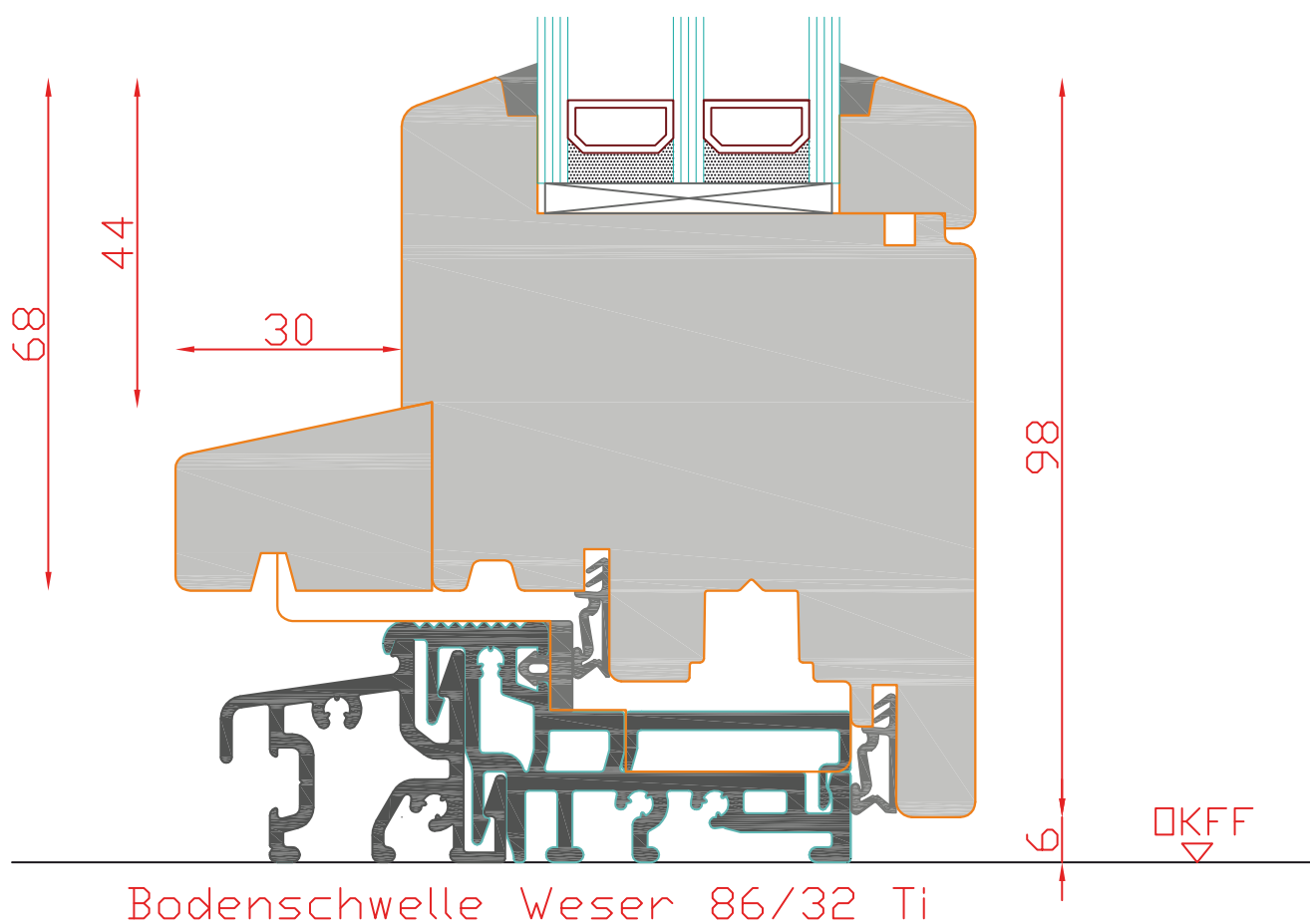

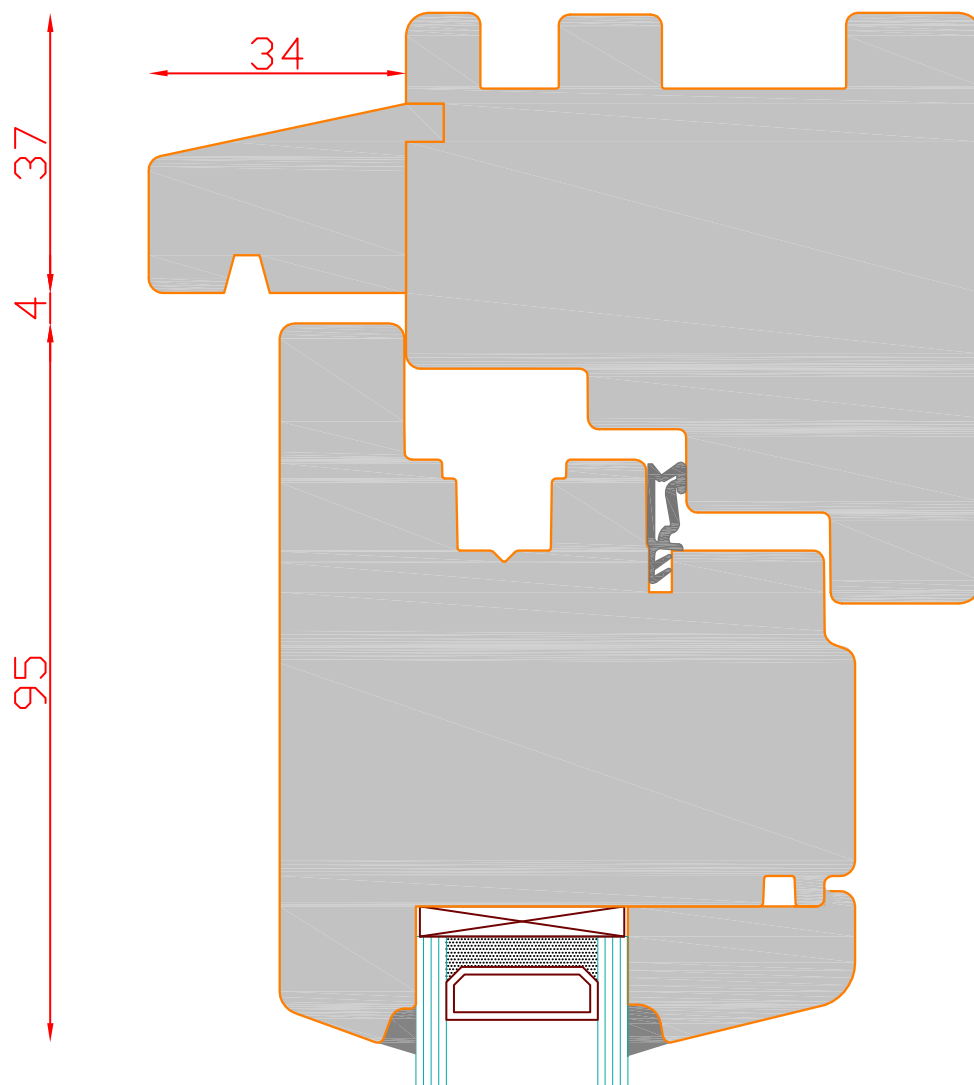
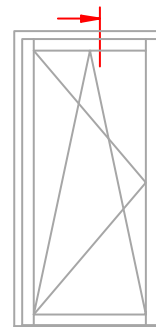

Glasstärken ab
28mm möglich



Glasstärken ab
28mm möglich

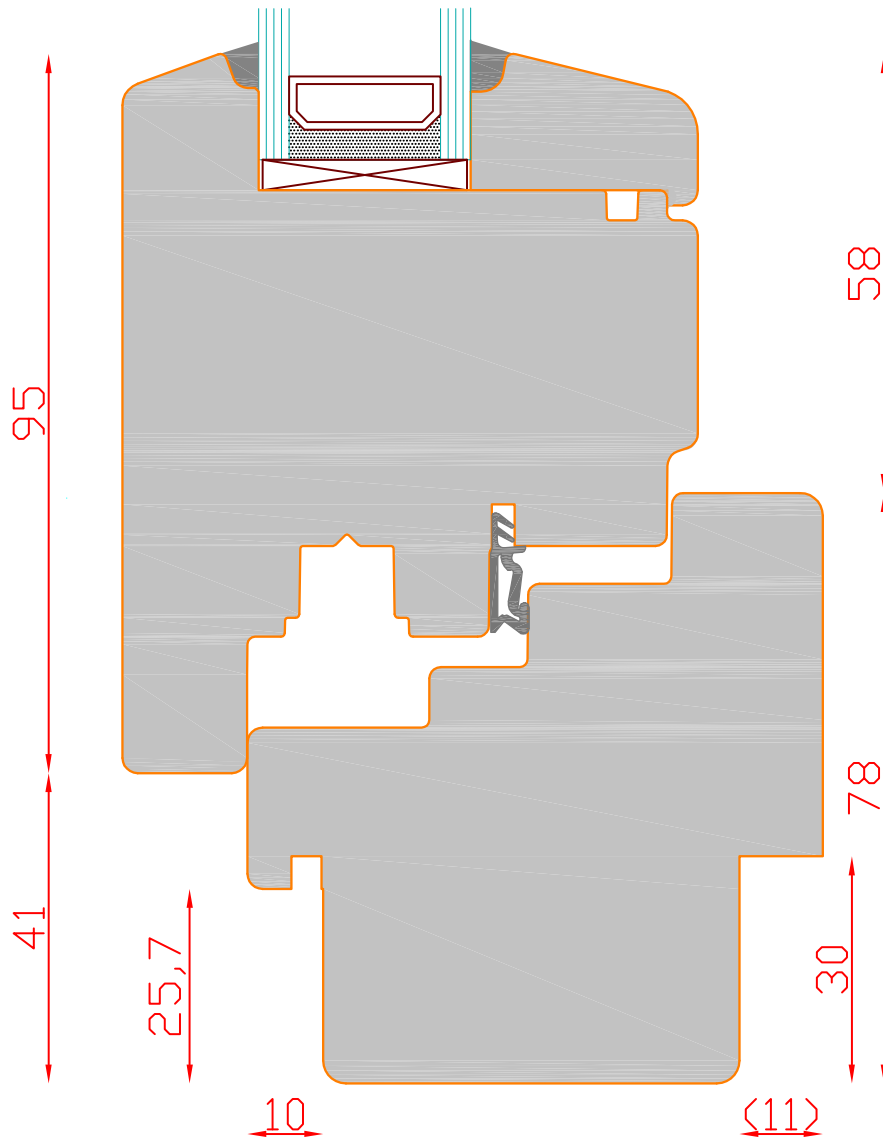
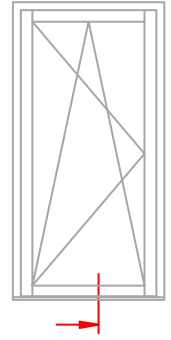

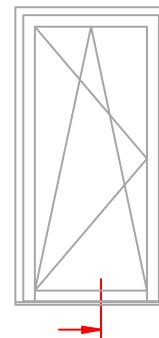

Glasstärken ab
28mm möglich

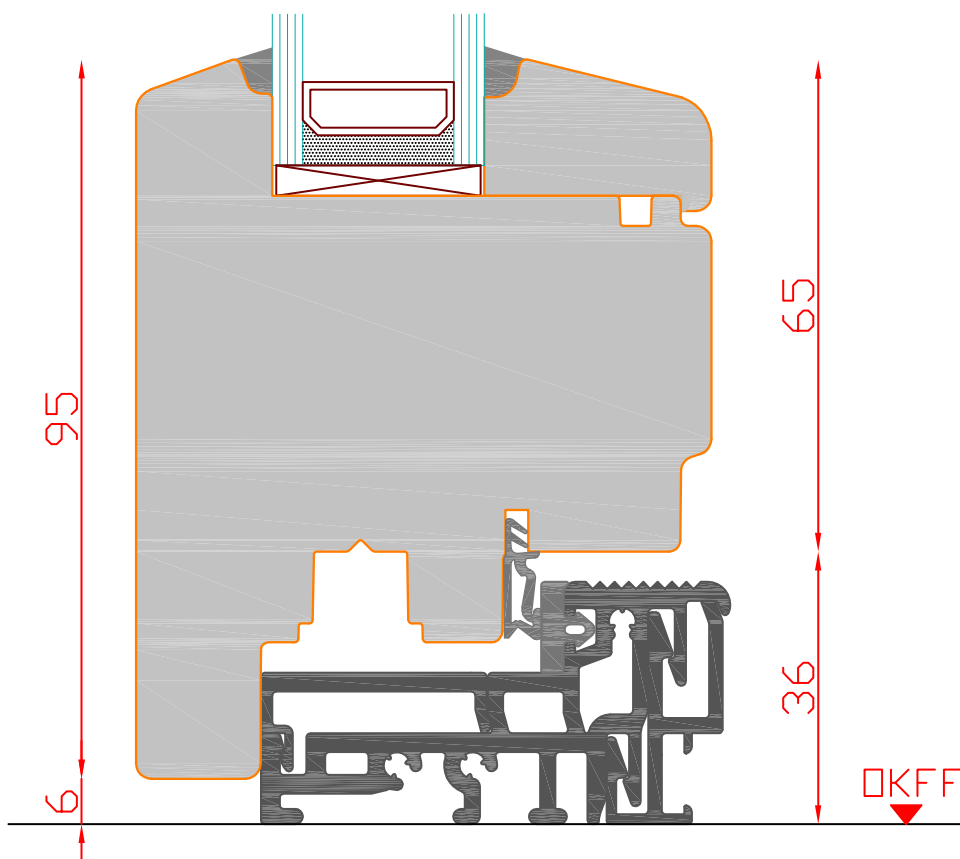

Bodenschwelle Weser-A 61/32 TI



IV76
HOLZFENSTERTÜR

Schnitt : Vertikal Bodenschwelle 32mm

Typ: Fenstertür auswärts öffnend | Seite: 69

SCHMIDT VISBEK
Fenster. Türen. Innovationen.

IV76

Rahmenverglasung
mit Falzwechsel

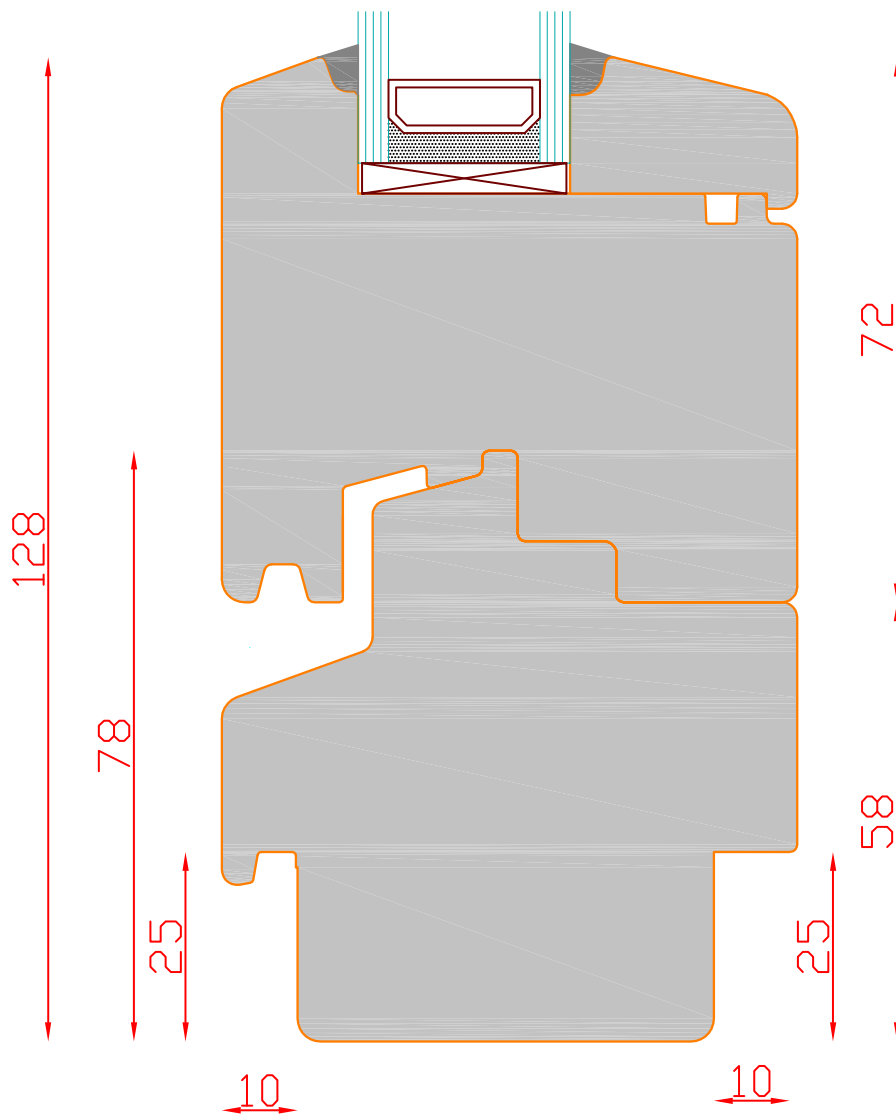
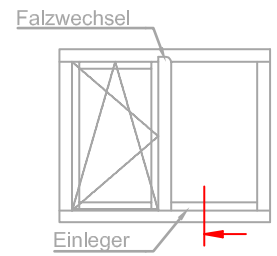

IV76
 RAHMENFESTVERGLASUNG
 MIT FALZWECHSEL

Schnitt : Vertikal unten mit Aufdopplung

Typ: Rahmenfestverglasung | Seite: **71**



SCHMIDT VISBEK
 Fenster. Türen. Innovationen.

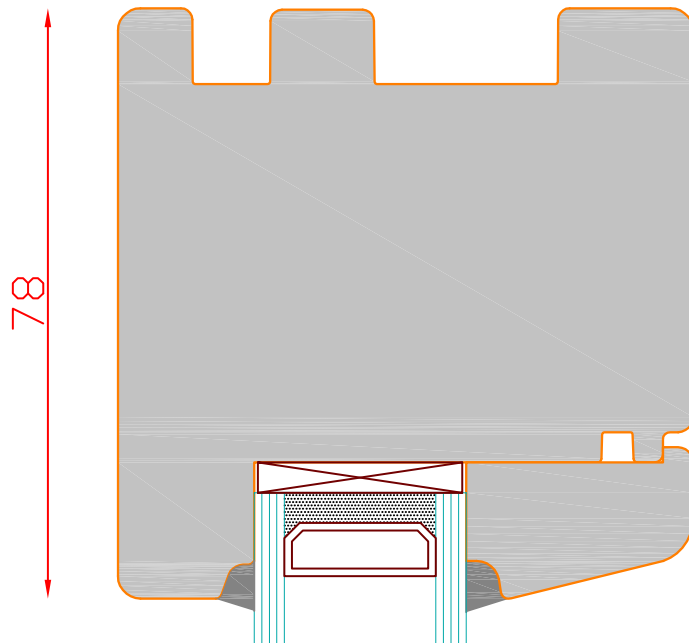
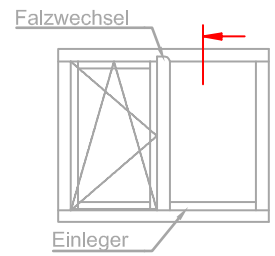

IV 88

Standard

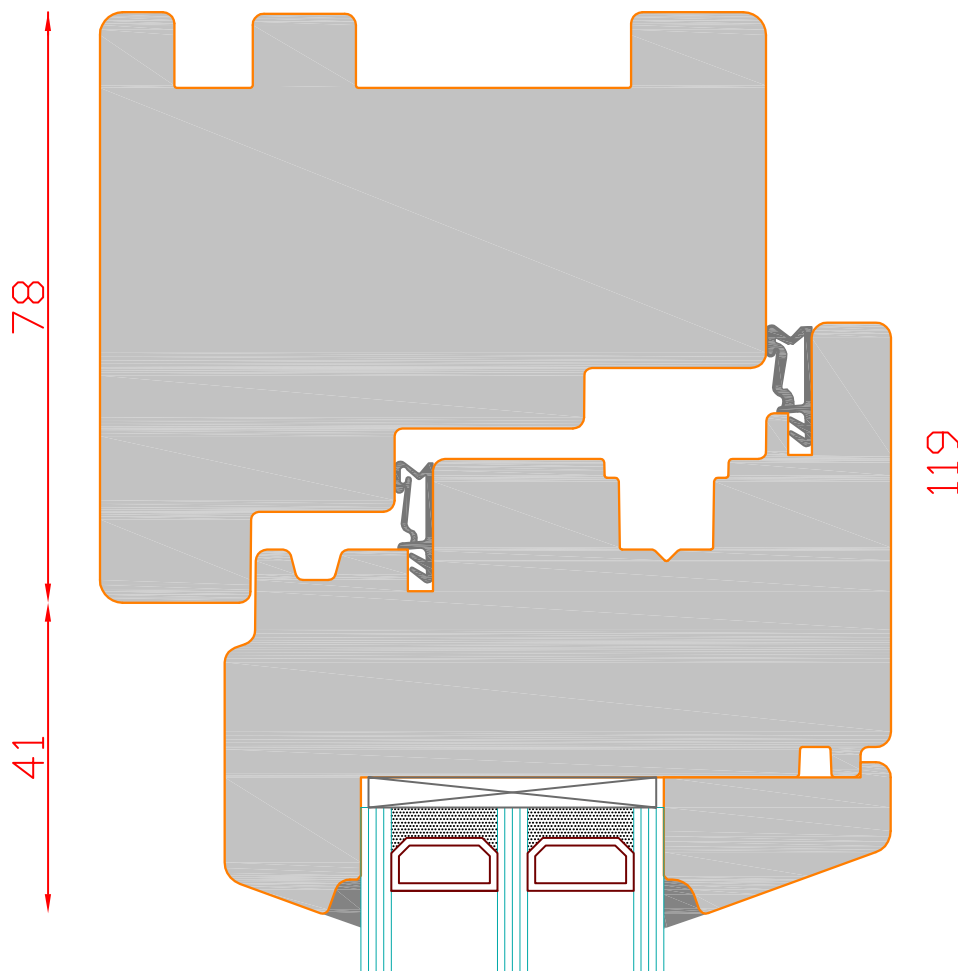
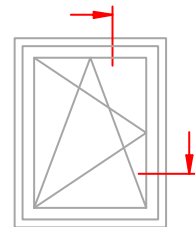

Glasstärken von
40mm-50mm möglich



IV88
STANDARD

Schnitt : Vertikal oben und seitlich

Typ: DK

| Seite: 74

SCHMIDT VISBEK
Fenster. Türen. Innovationen.

Glasstärken von
40mm-50mm möglich

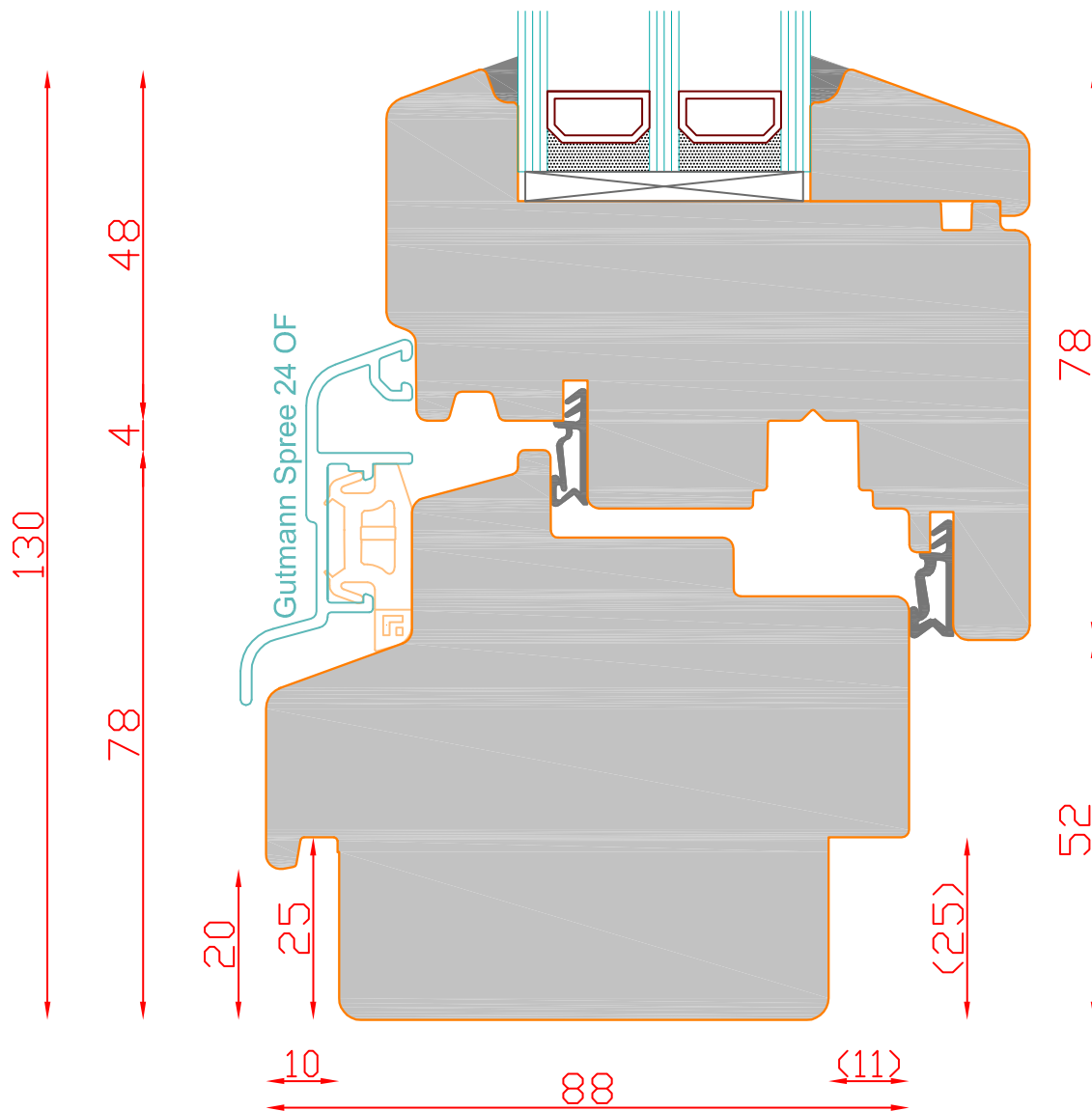
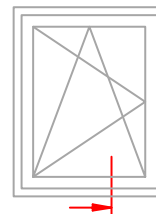

IV88
STANDARD

Schnitt : Vertikal unten

Typ: DK / Alu-Regenschiene

| Seite: 75



SCHMIDT VISBEK
Fenster. Türen. Innovationen.

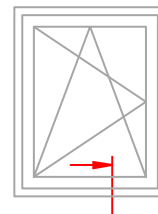

Glasstärken von
40mm-50mm möglich

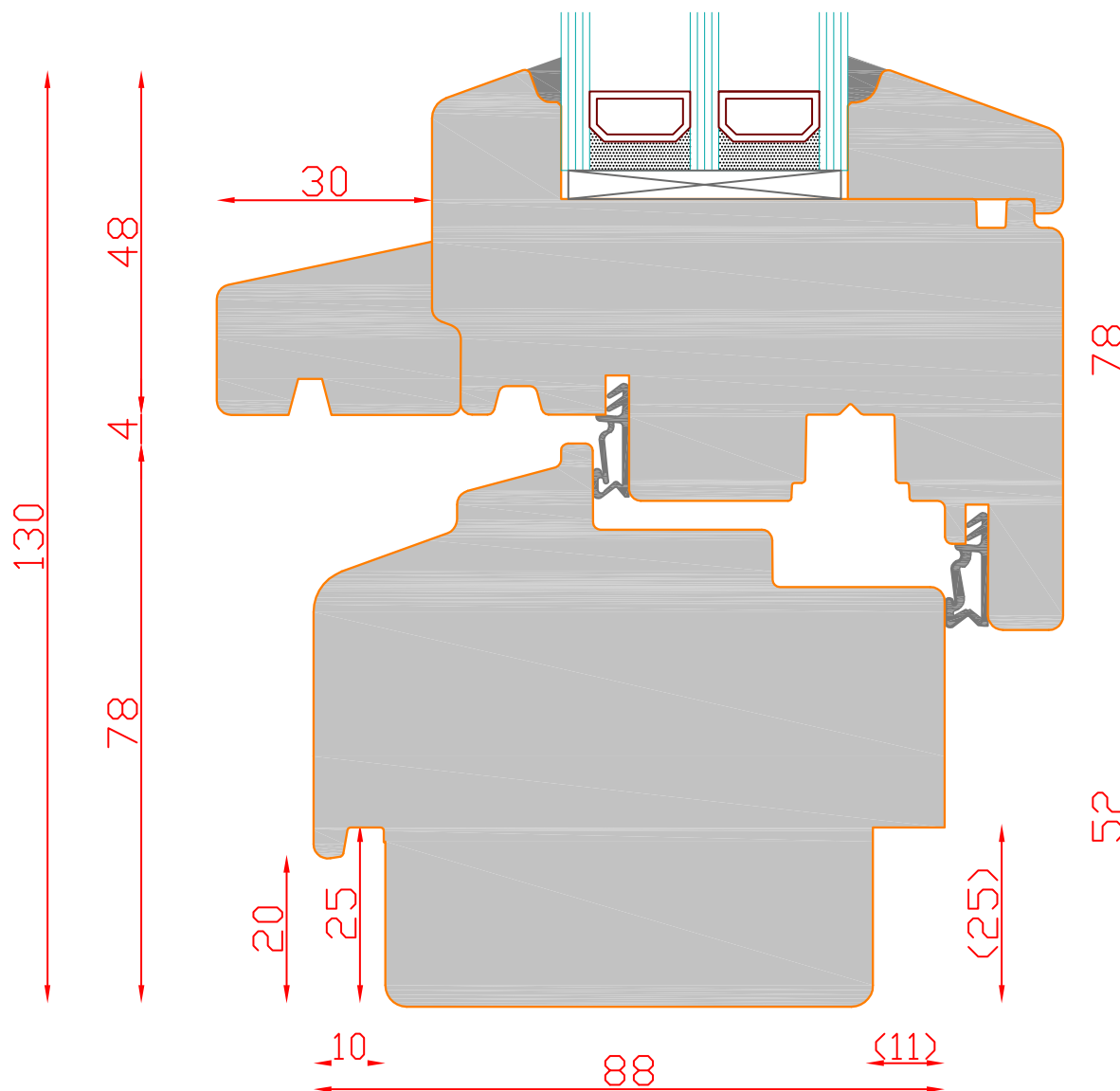

IV88
STANDARD

Schnitt : Vertikal unten

Typ: DK / ohne Regenschiene | Seite: 76

SCHMIDT VISBEK
Fenster. Türen. Innovationen.



Glasstärken von
40mm-50mm möglich

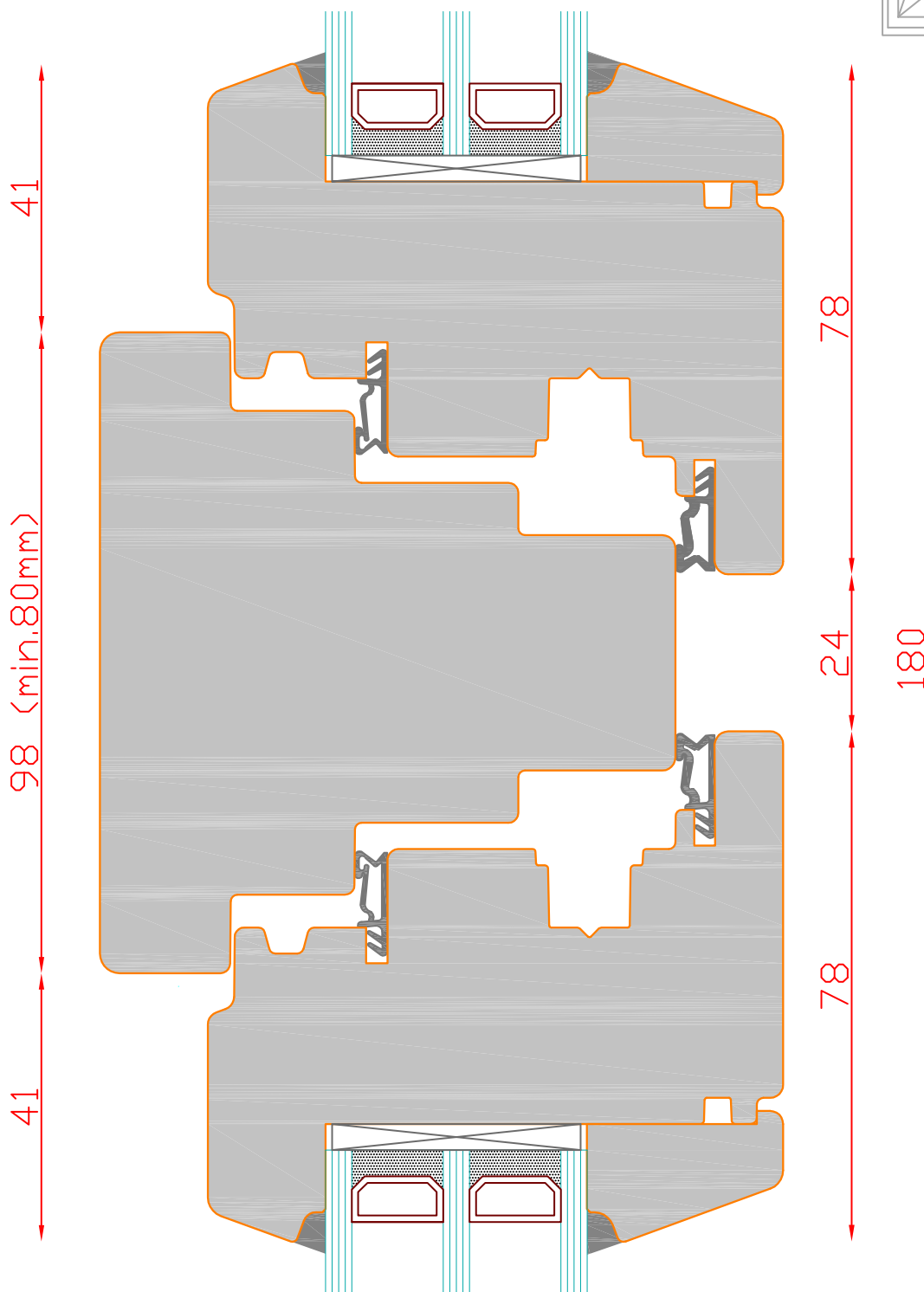
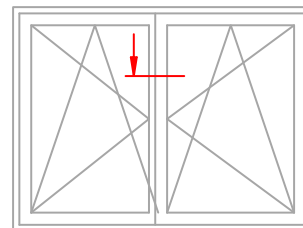

Glasstärken von
40mm-50mm möglich



IV88
STANDARD

Schnitt : Horizontal/Pfosten 100mm

Typ: DK -DK

| Seite: 77

SCHMIDT VISBEK
Fenster. Türen. Innovationen.

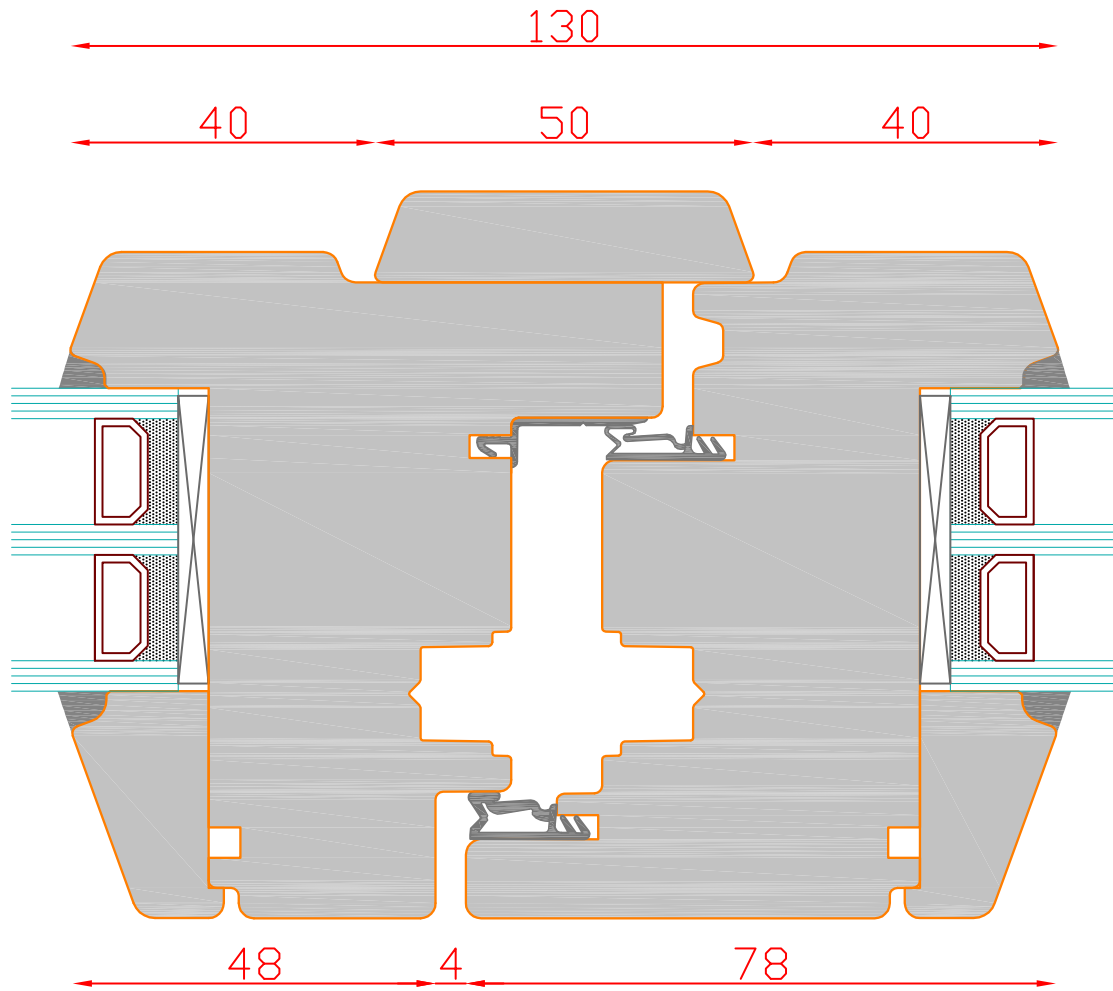
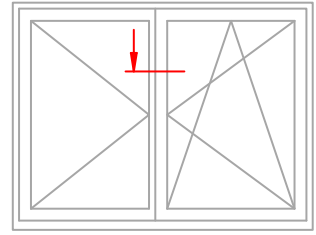

Glasstärken von
40mm-50mm möglich



IV88
STANDARD

Schnitt :Horizontal / Stulp

Typ: D - DK / Schlagleiste aufgesetzt | Seite: 78

SCHMIDT VISBEK
Fenster. Türen. Innovationen.

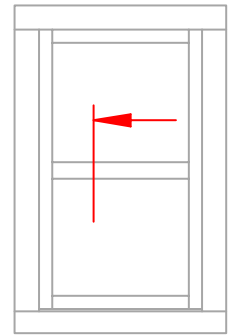

Glasstärken von
40mm-50mm möglich

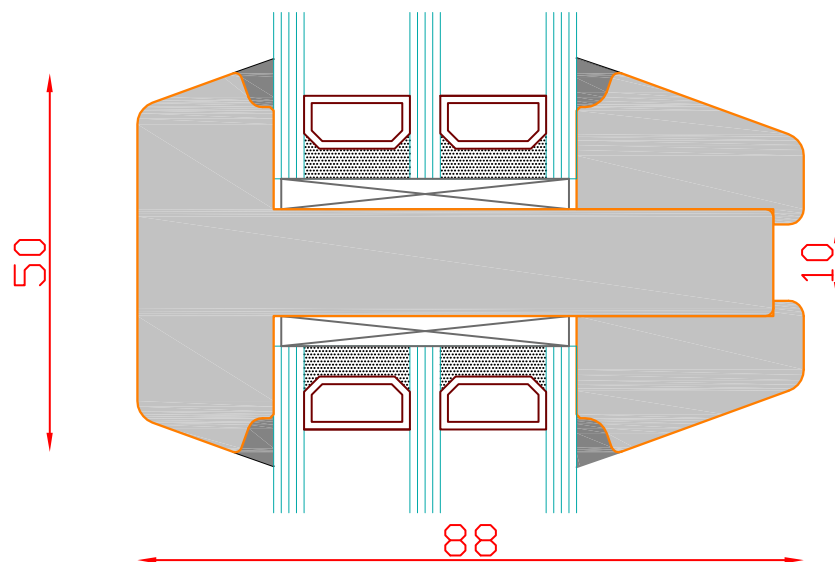

IV88
S-PROFIL

Schnitt : Vertikal 50mm Sprosse

Typ: Konter/Dübel

| Seite: 79

SCHMIDT VISBEK
Fenster. Türen. Innovationen.

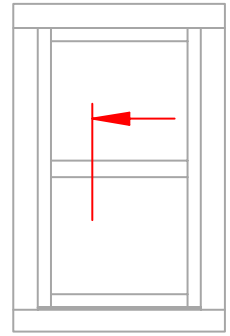

Glasstärken von
40mm-50mm möglich

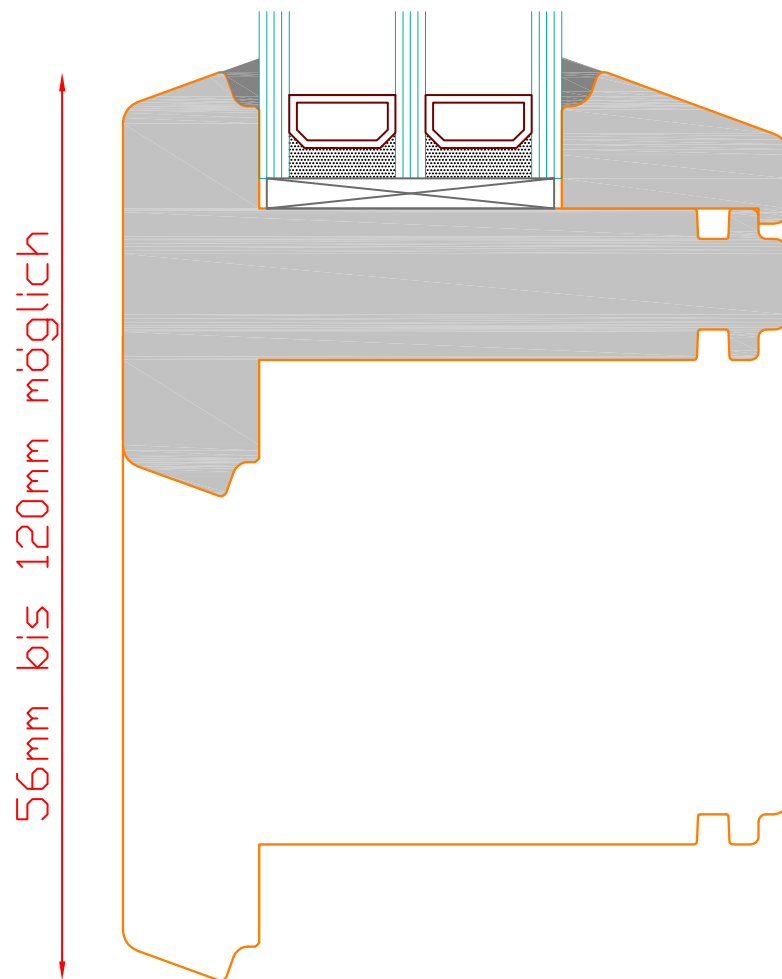

IV88
STANDARD

Schnitt : Vertikal 56-120mm Sprosse

Typ: Konter/Dübel

| Seite: 80

SCHMIDT VISBEK
Fenster. Türen. Innovationen.

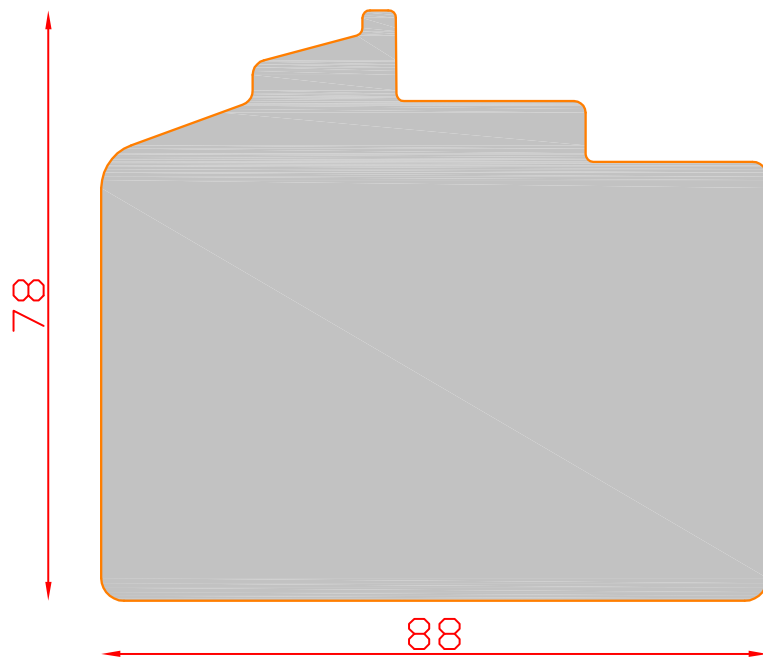

IV88
STANDARD

Schnitt : Vertikal

Typ: stumpf

| Seite: 81

SCHMIDT VISBEK
Fenster. Türen. Innovationen.

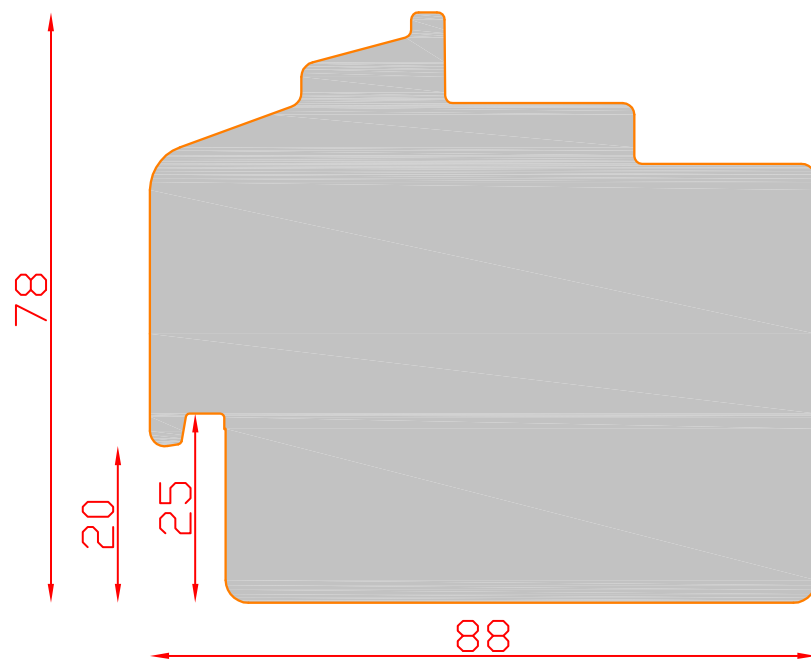

IV88
STANDARD

Schnitt : Vertikal

Typ: Alubankfalz außen

| Seite: 82

SCHMIDT VISBEK
Fenster. Türen. Innovationen.

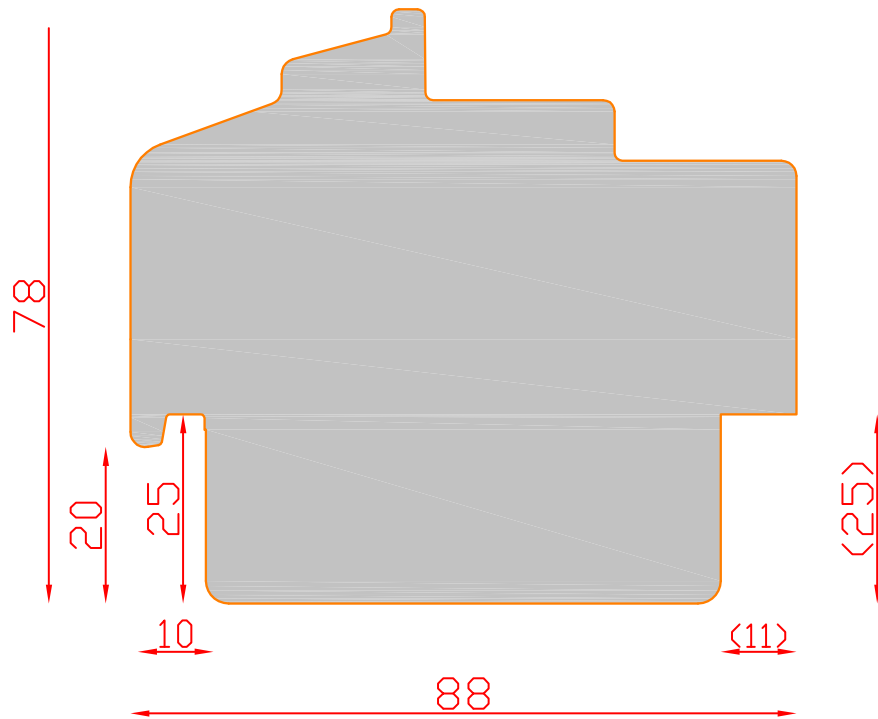

IV88
STANDARD

Schnitt : Vertikal

Typ: Alubankfalz 25mm

| Seite: 83

SCHMIDT VISBEK
Fenster. Türen. Innovationen.

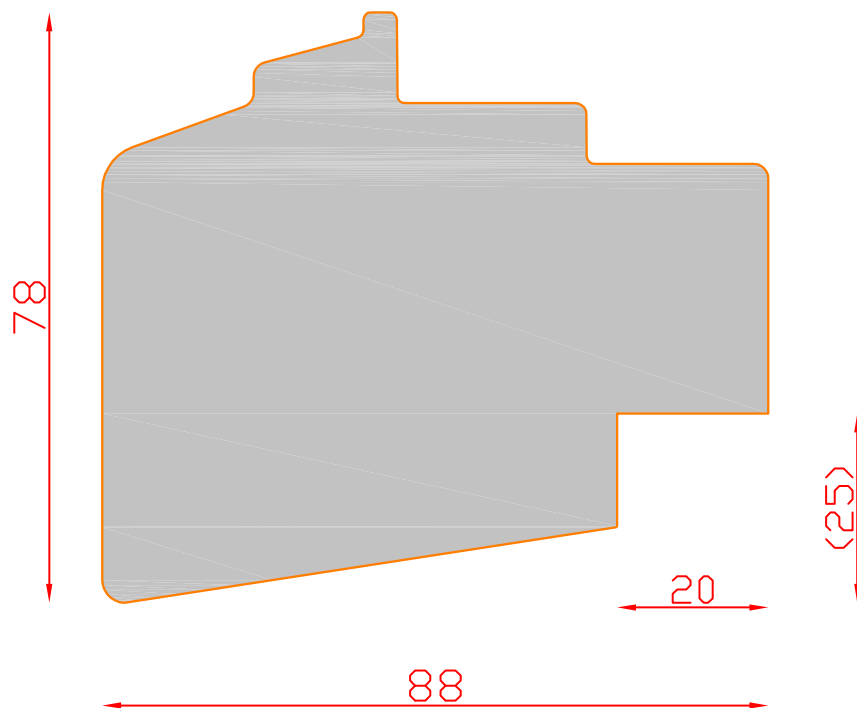

IV88
STANDARD

Schnitt : Vertikal

Typ: Altbauschräge 25mm

| Seite: **84**

SCHMIDT VISBEK
Fenster. Türen. Innovationen.

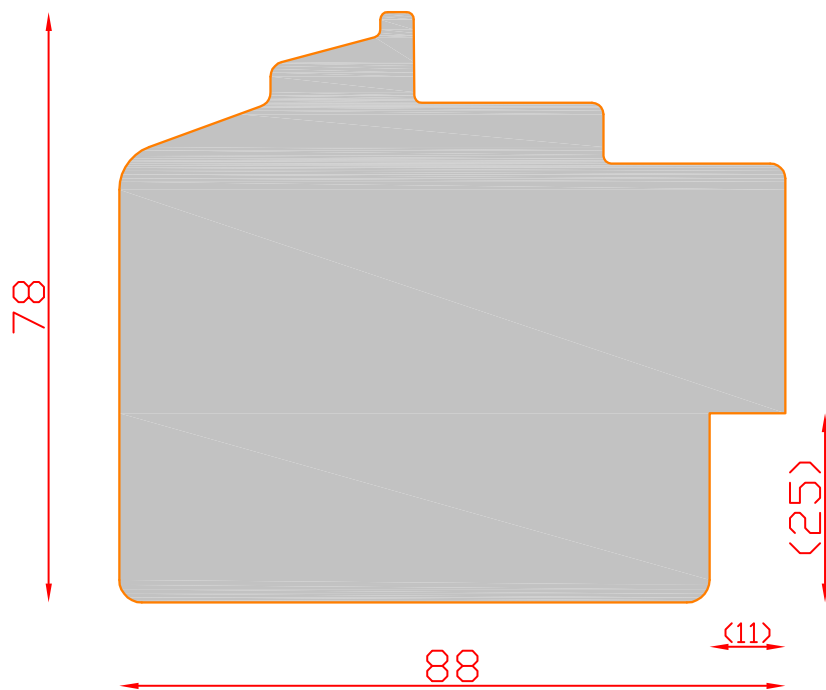

IV88
STANDARD

Schnitt : Vertikal

Typ: Peinemann 25mm

| Seite: 85

SCHMIDT VISBEK
Fenster. Türen. Innovationen.

IV 88

S-Profil

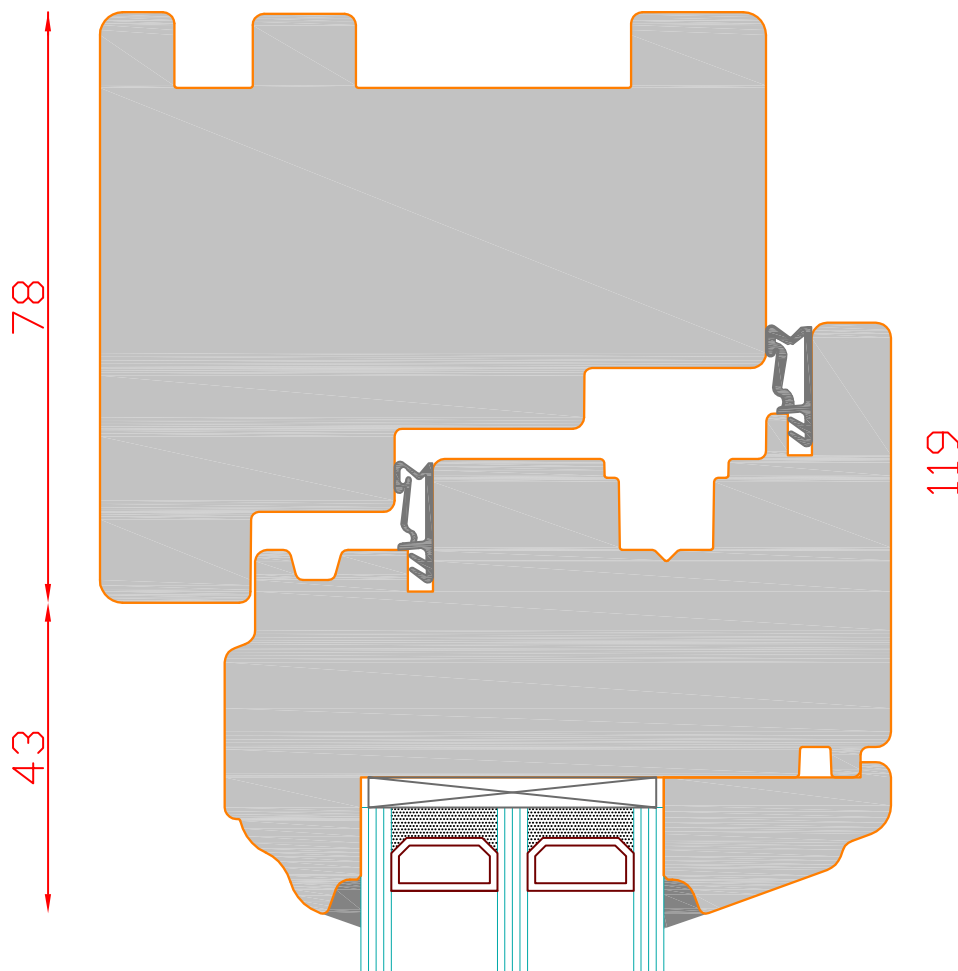
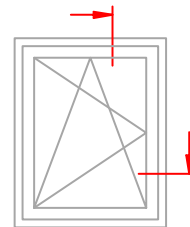

Glasstärken von
40mm-50mm möglich



IV88
S-PROFIL

Schnitt : Vertikal oben und seitlich

Typ: DK

| Seite: 87

SCHMIDT VISBEK
Fenster. Türen. Innovationen.

Glasstärken von
40mm-50mm möglich

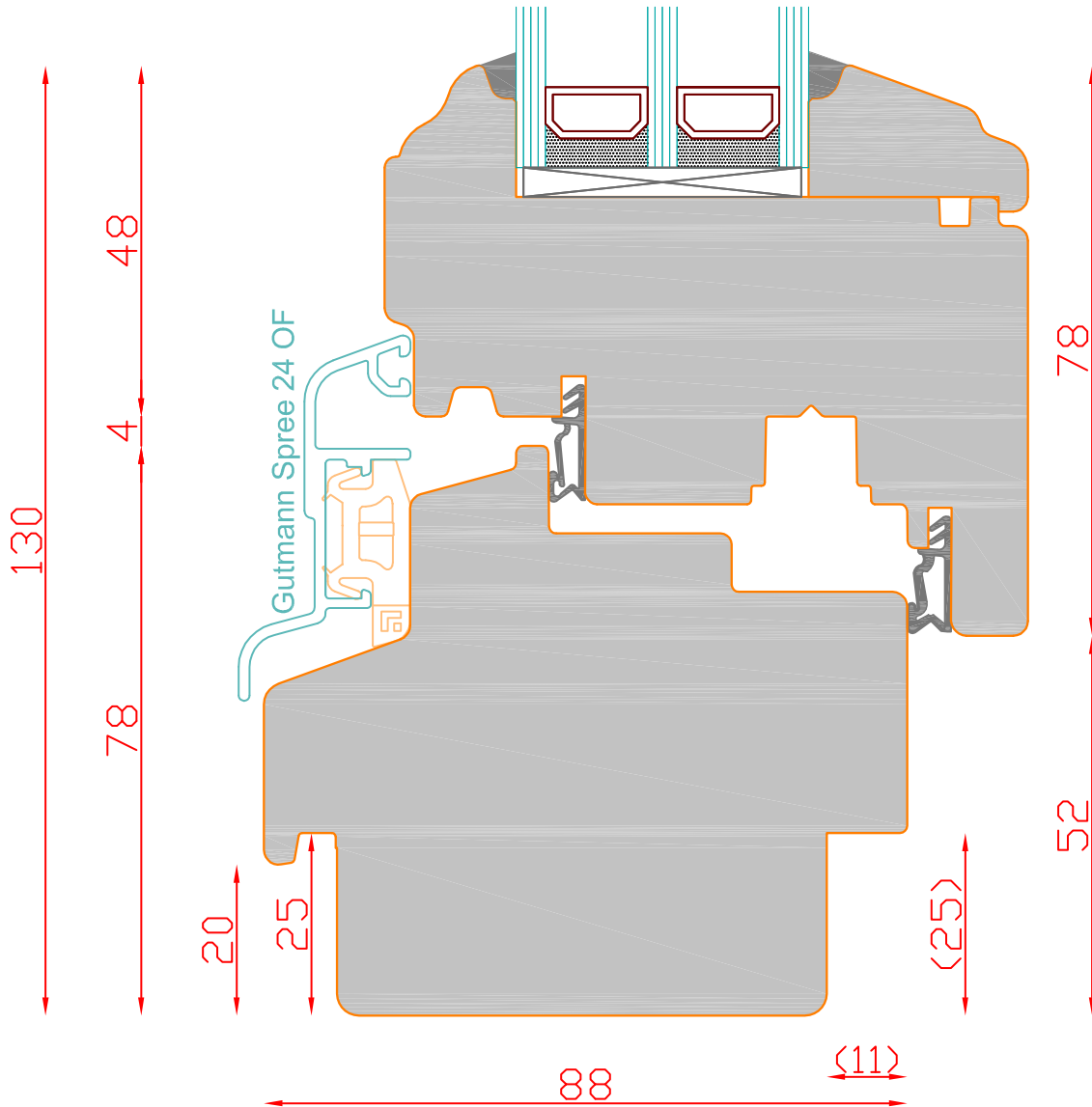
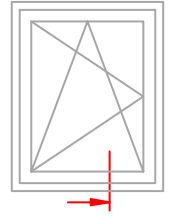

IV88
S-PROFIL

Schnitt : Vertikal unten

Typ: DK / Alu-Regenschiene

| Seite: 88



SCHMIDT VISBEK
Fenster. Türen. Innovationen.

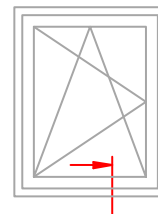

Glasstärken von
40mm-50mm möglich

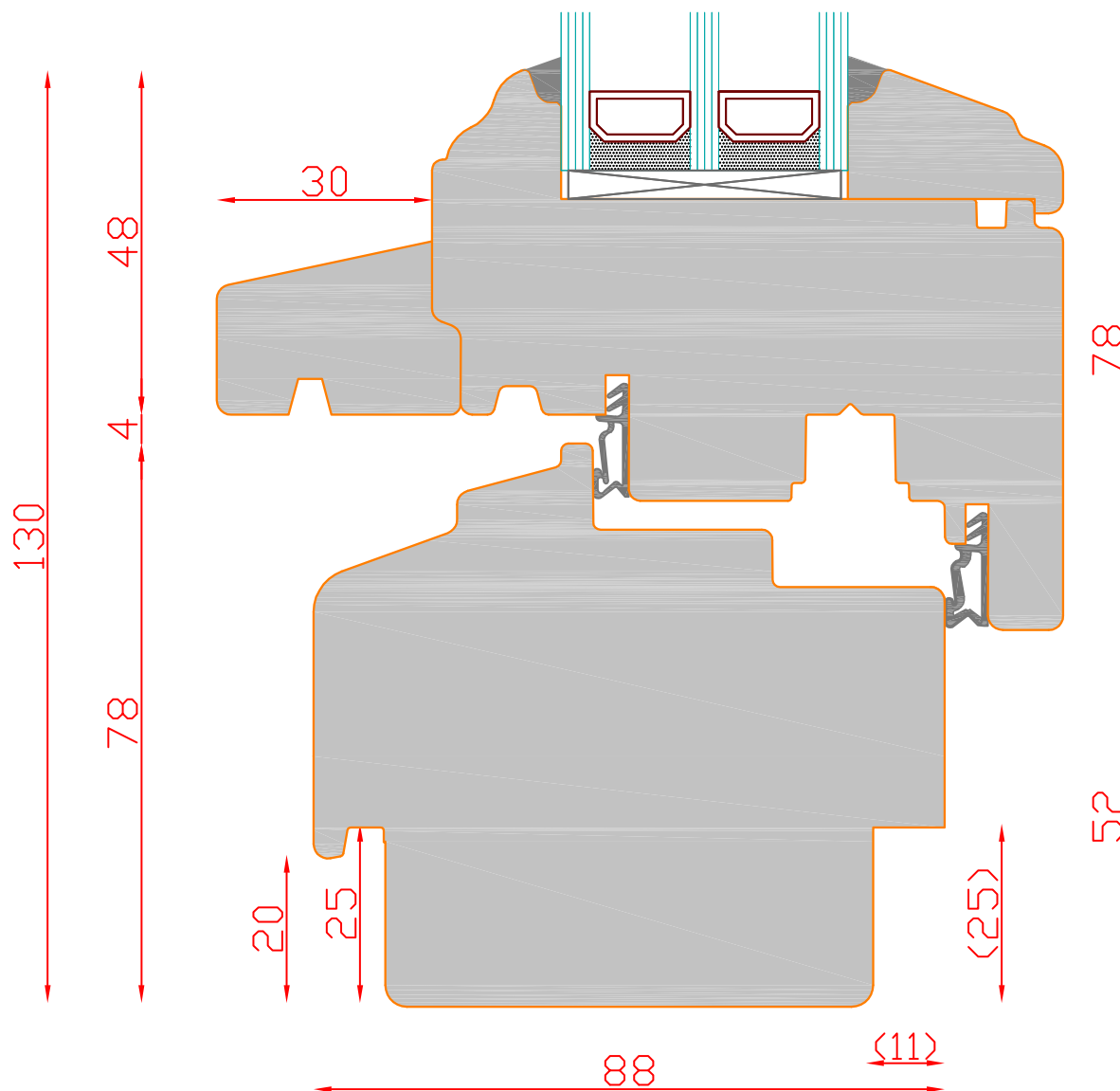

IV88
S-PROFIL

Schnitt : Vertikal unten

Typ: DK / ohne Regenschiene | Seite: 89

SCHMIDT VISBEK
Fenster. Türen. Innovationen.



Glasstärken von
40mm-50mm möglich

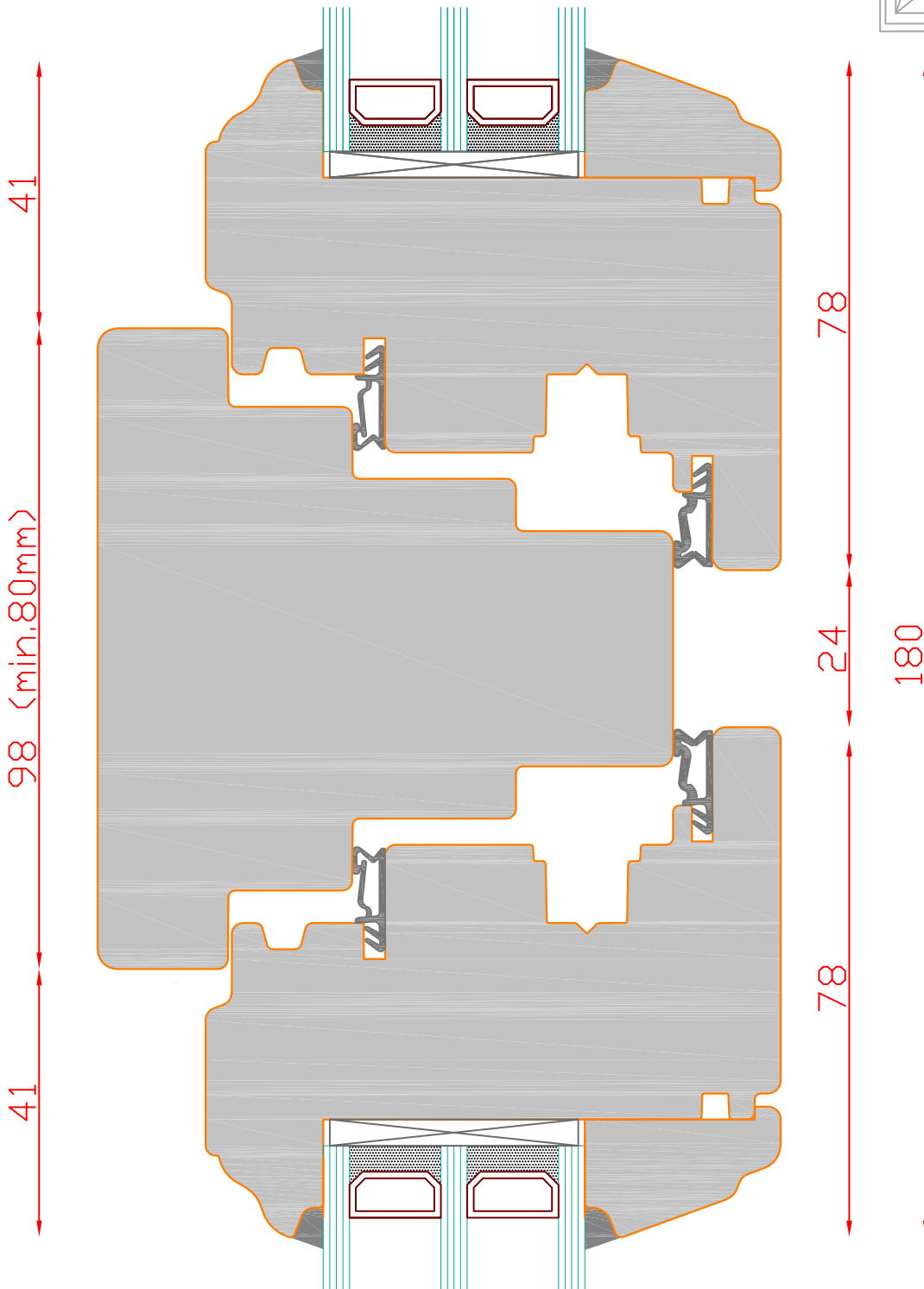
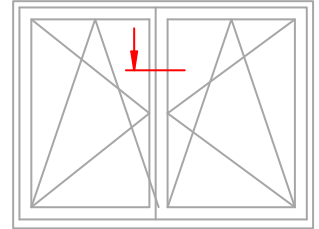

Glasstärken von
40mm-50mm möglich



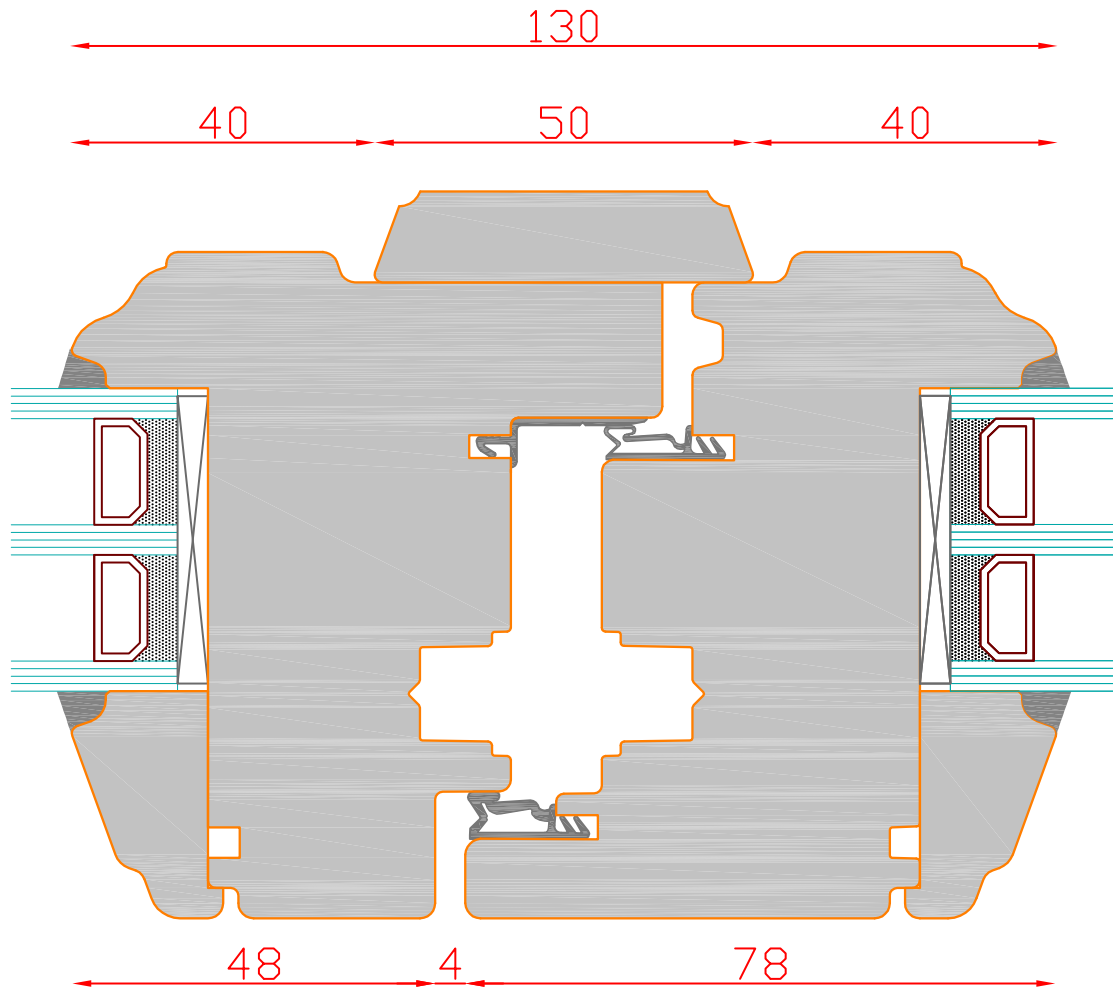
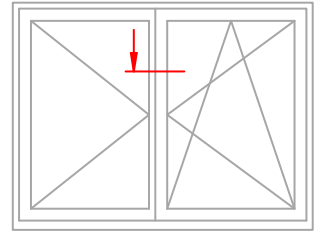

Glasstärken von
40mm-50mm möglich



IV88
S-PROFIL

Schnitt :Horizontal / Stulp

Typ: D - DK / Schlagleiste aufgesetzt | Seite: 91

SCHMIDT VISBEK
Fenster. Türen. Innovationen.

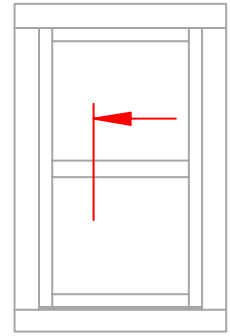

Glasstärken von
40mm-50mm möglich

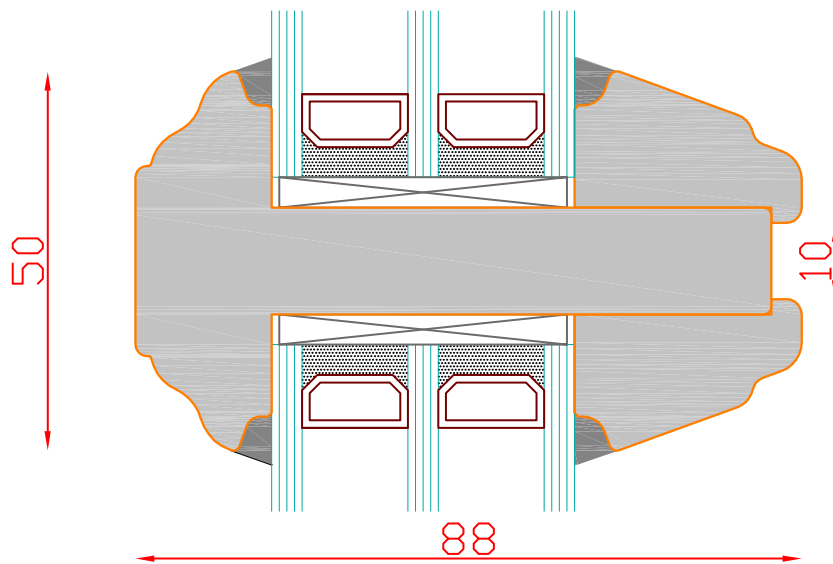

IV88
STANDARD

Schnitt : Vertikal 50mm Sprosse

Typ: Konter/Dübel

| Seite: 92

SCHMIDT VISBEK
Fenster. Türen. Innovationen.

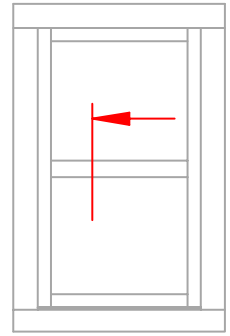

Glasstärken von
40mm-50mm möglich

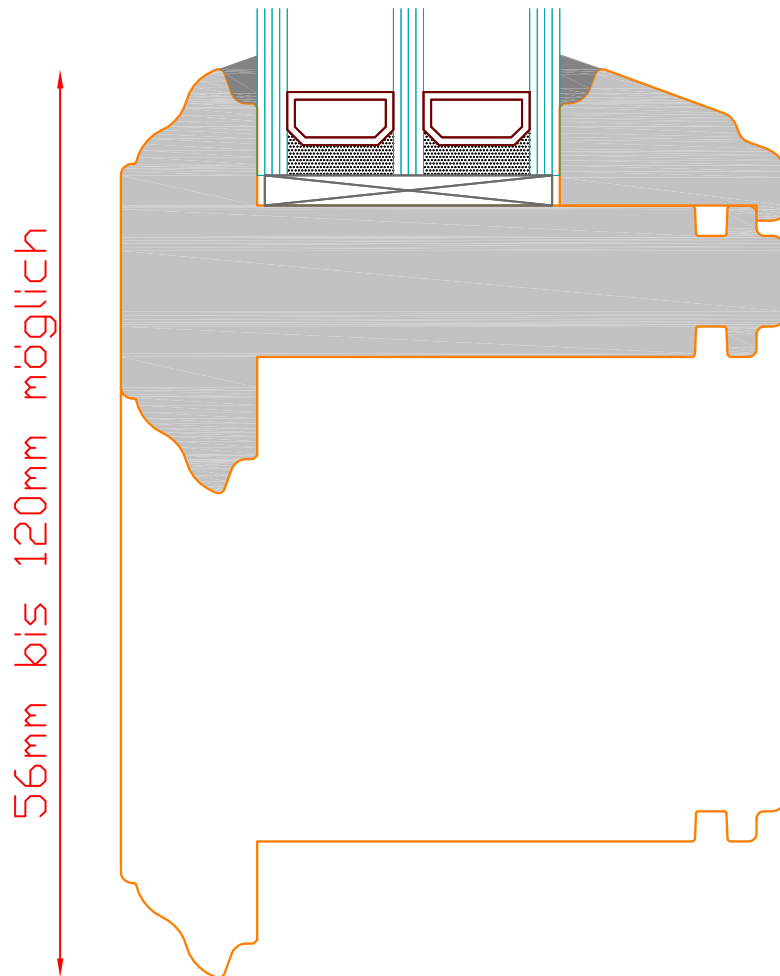

IV88
S-PROFIL

Schnitt : Vertikal 56-120mm Sprosse

Typ: Konter/Dübel

| Seite: 93

SCHMIDT VISBEK
Fenster. Türen. Innovationen.

ZUBEHÖR

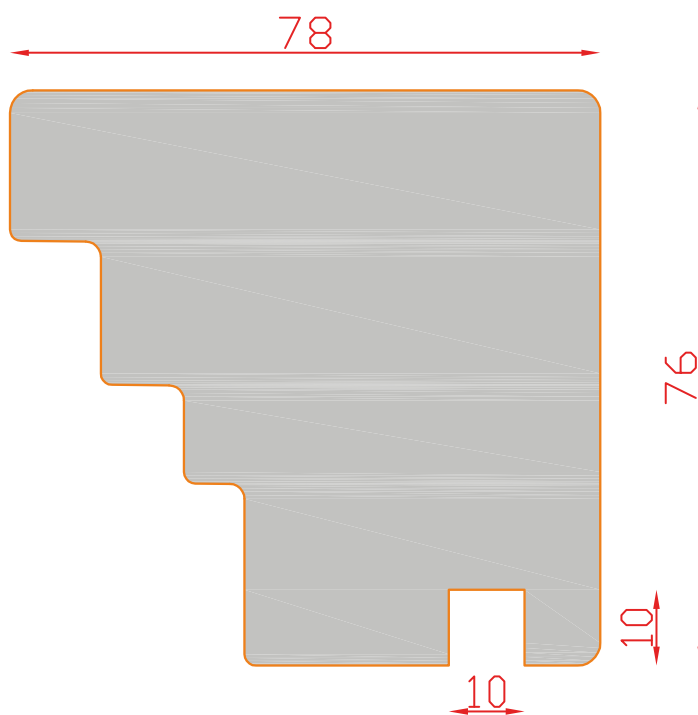

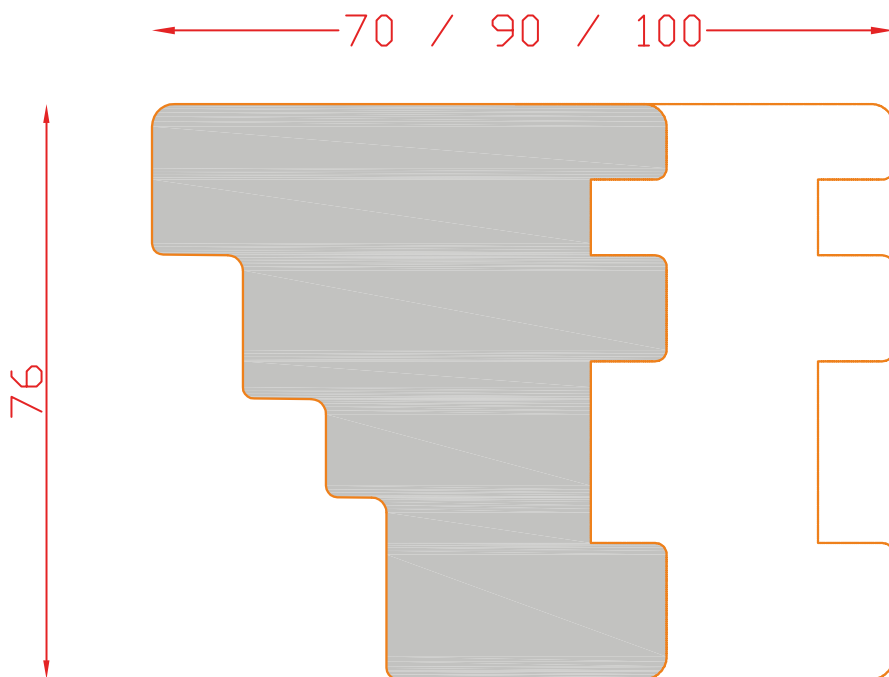

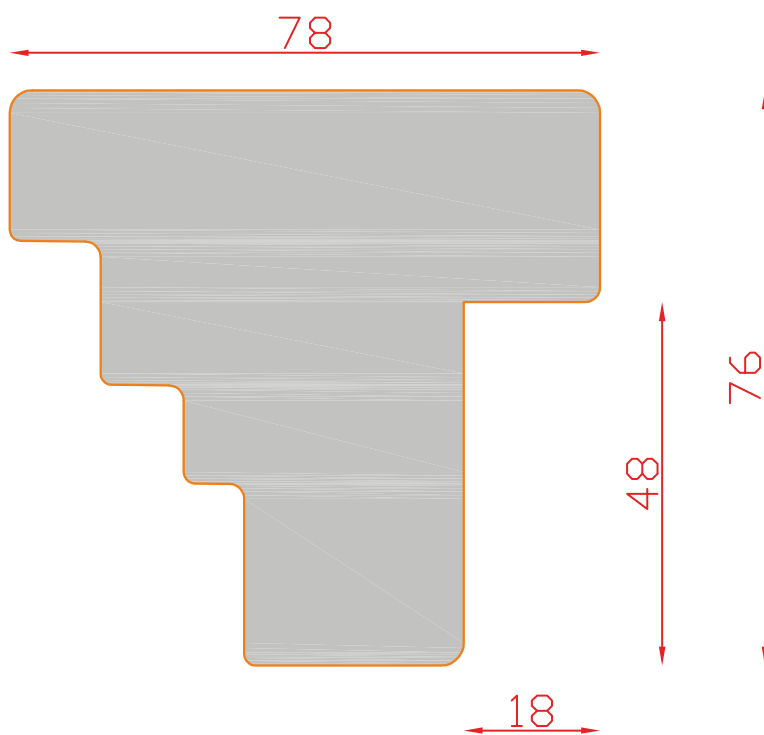

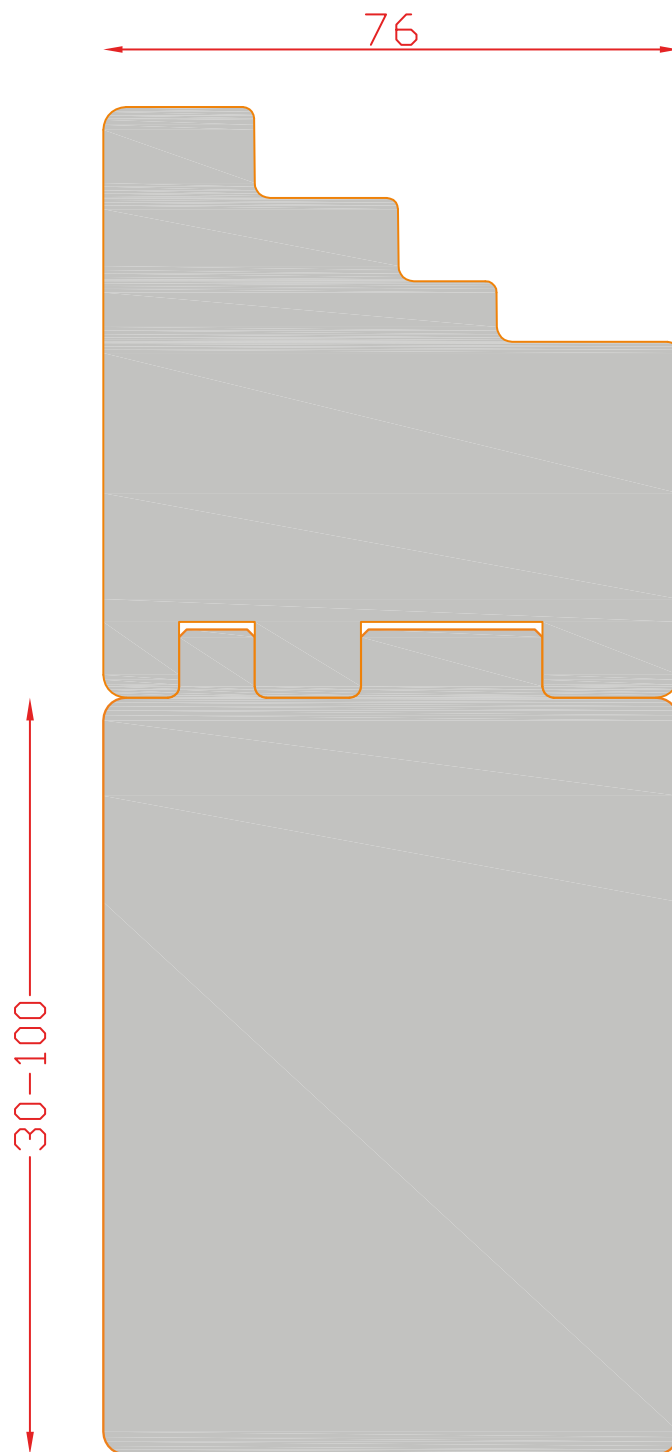

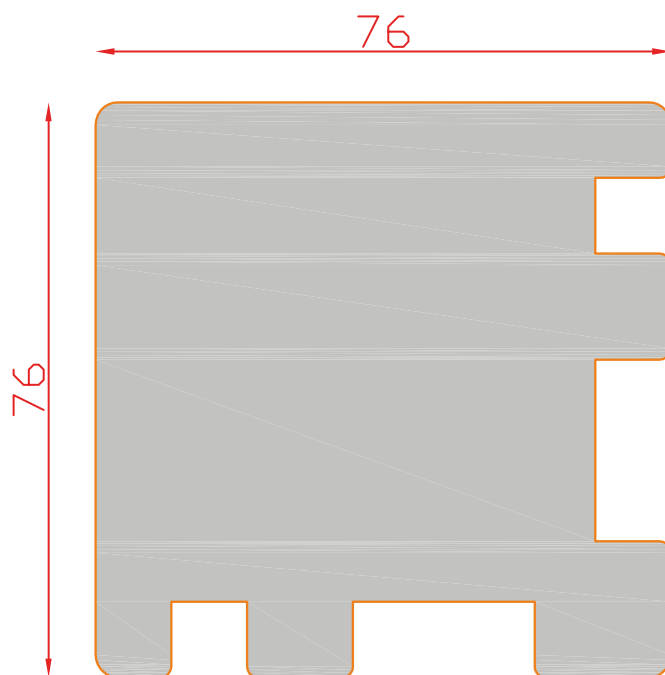

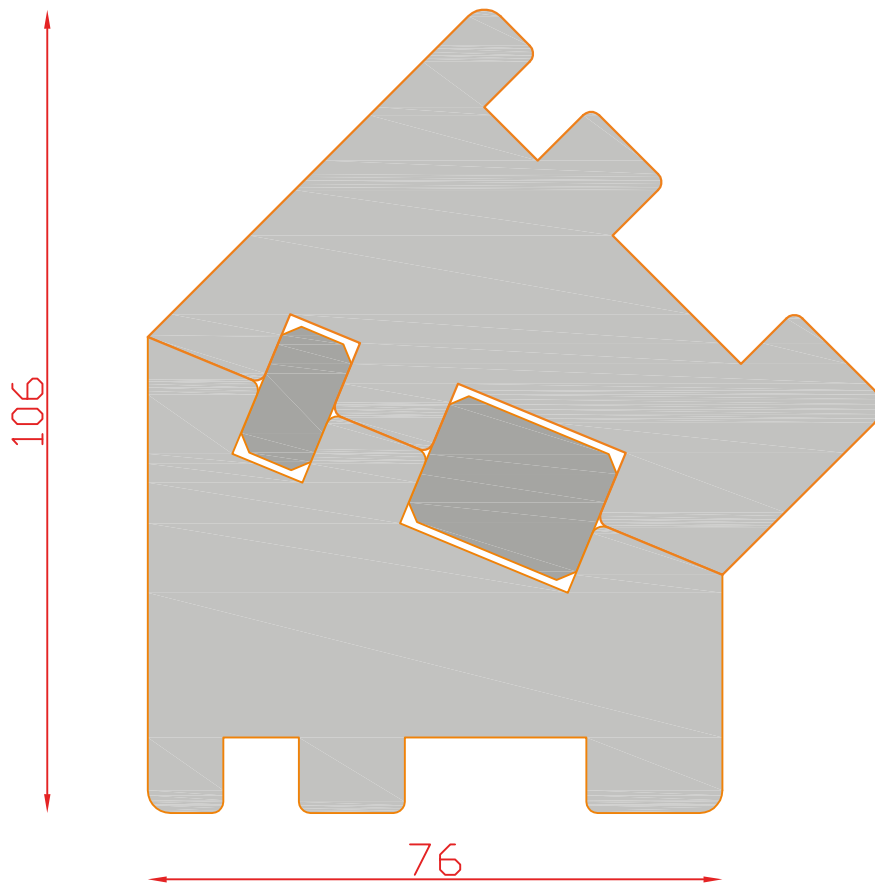

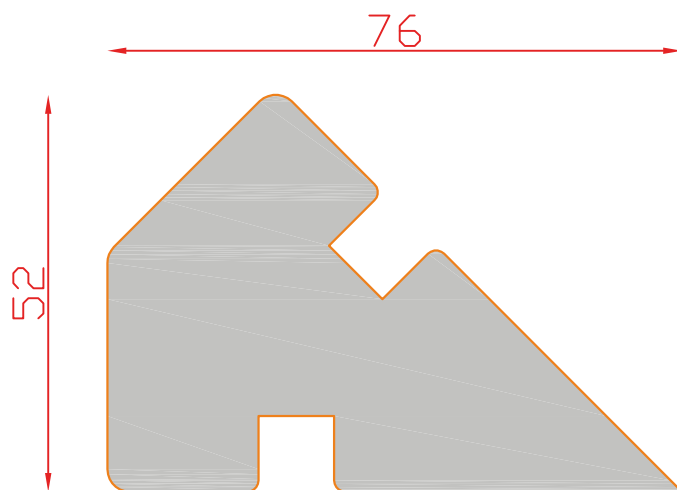

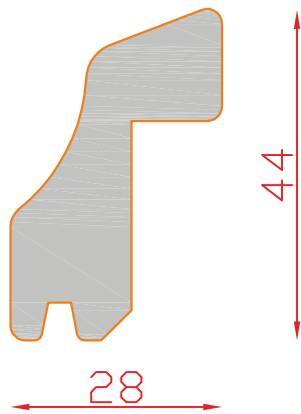
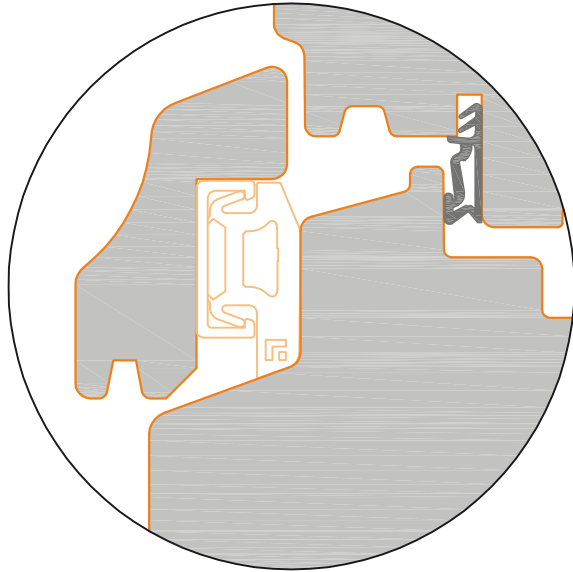

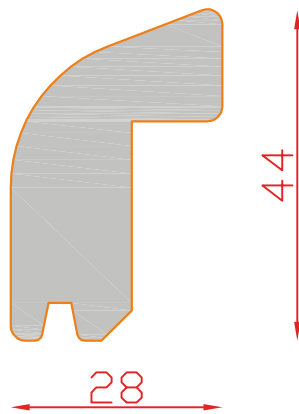
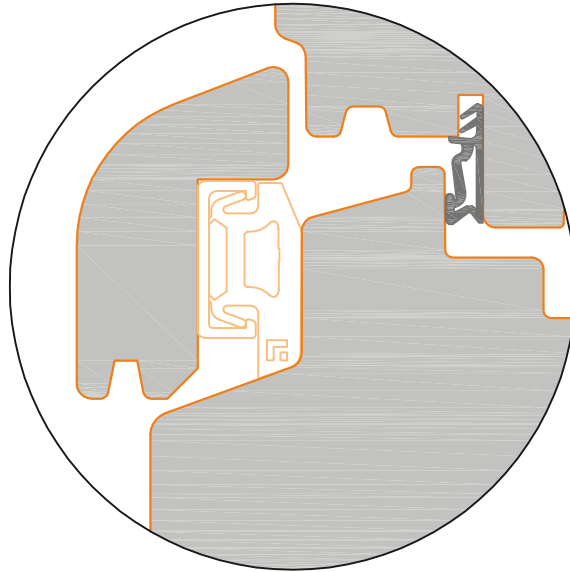

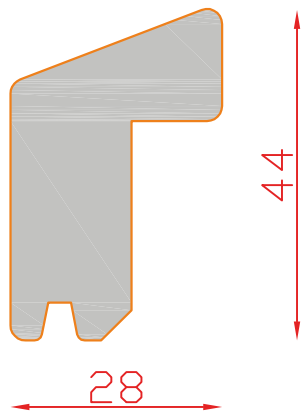
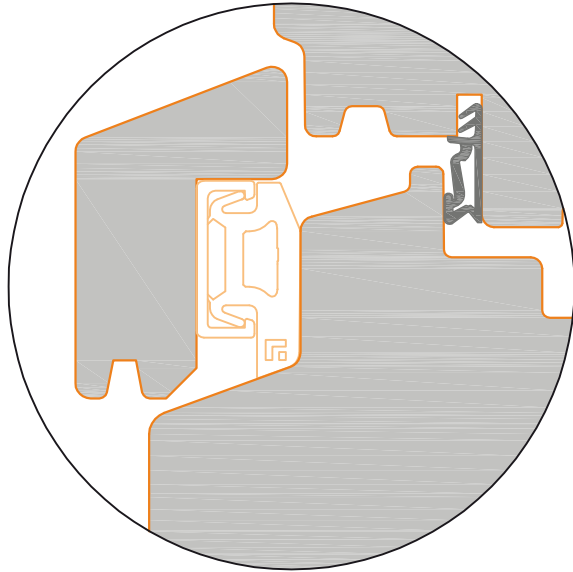

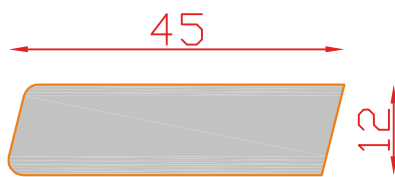
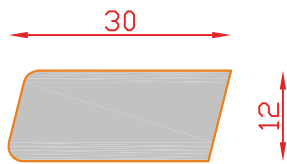
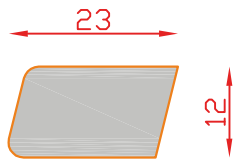

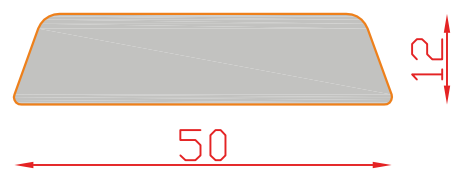
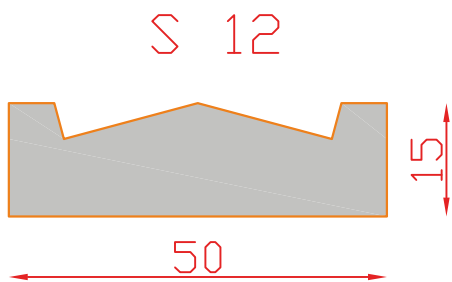
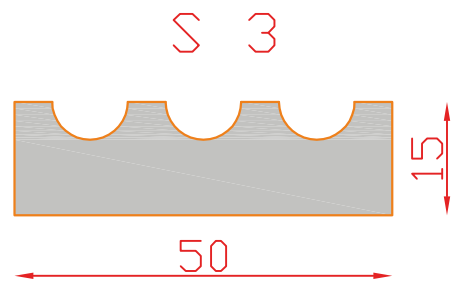
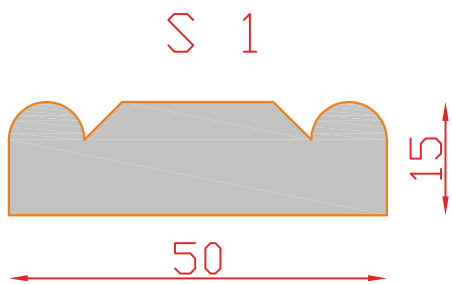
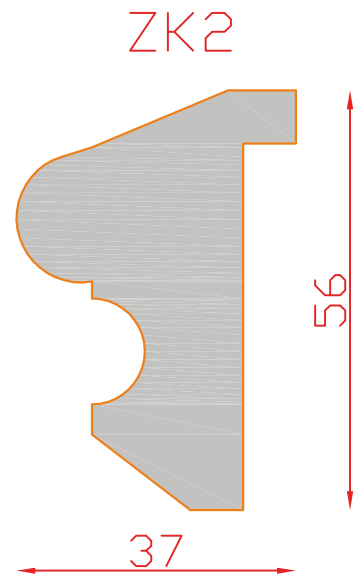
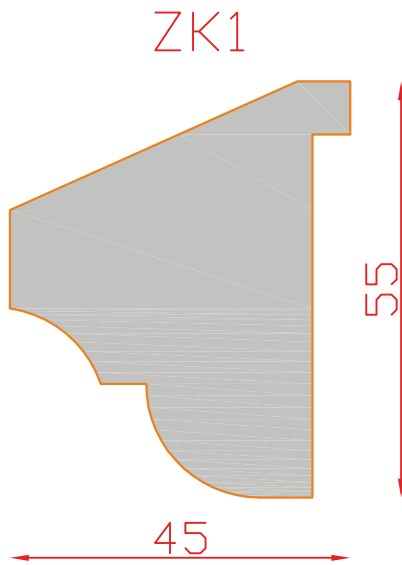
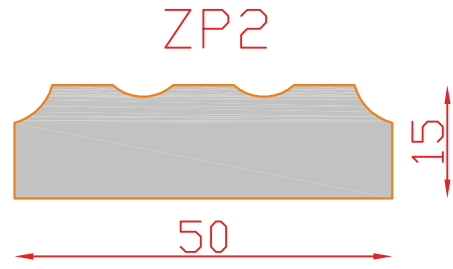
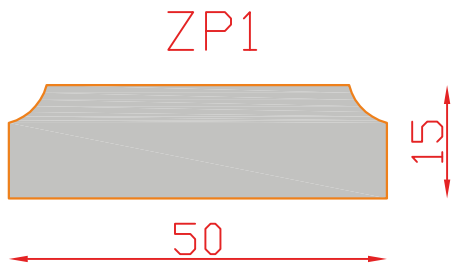

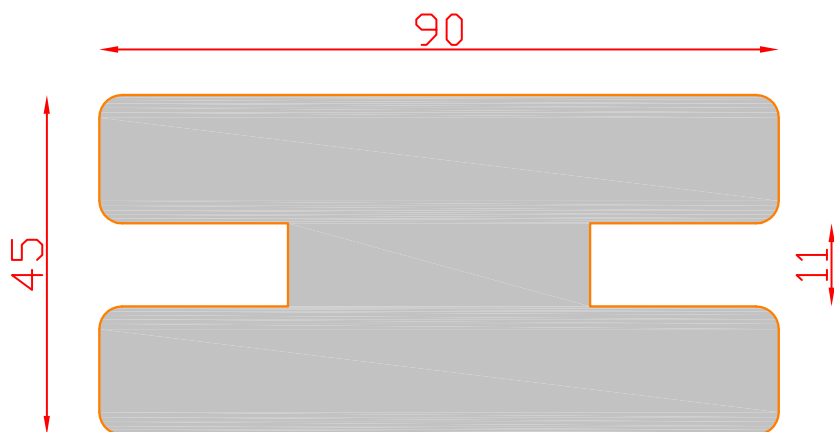
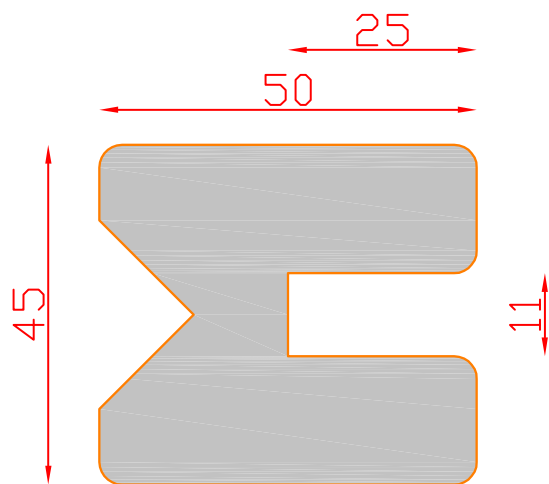
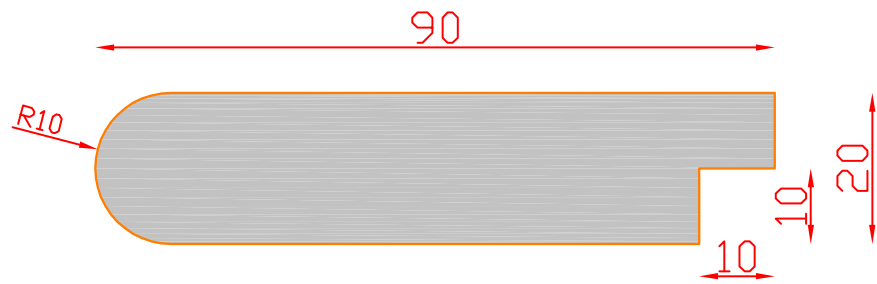

DUO 86

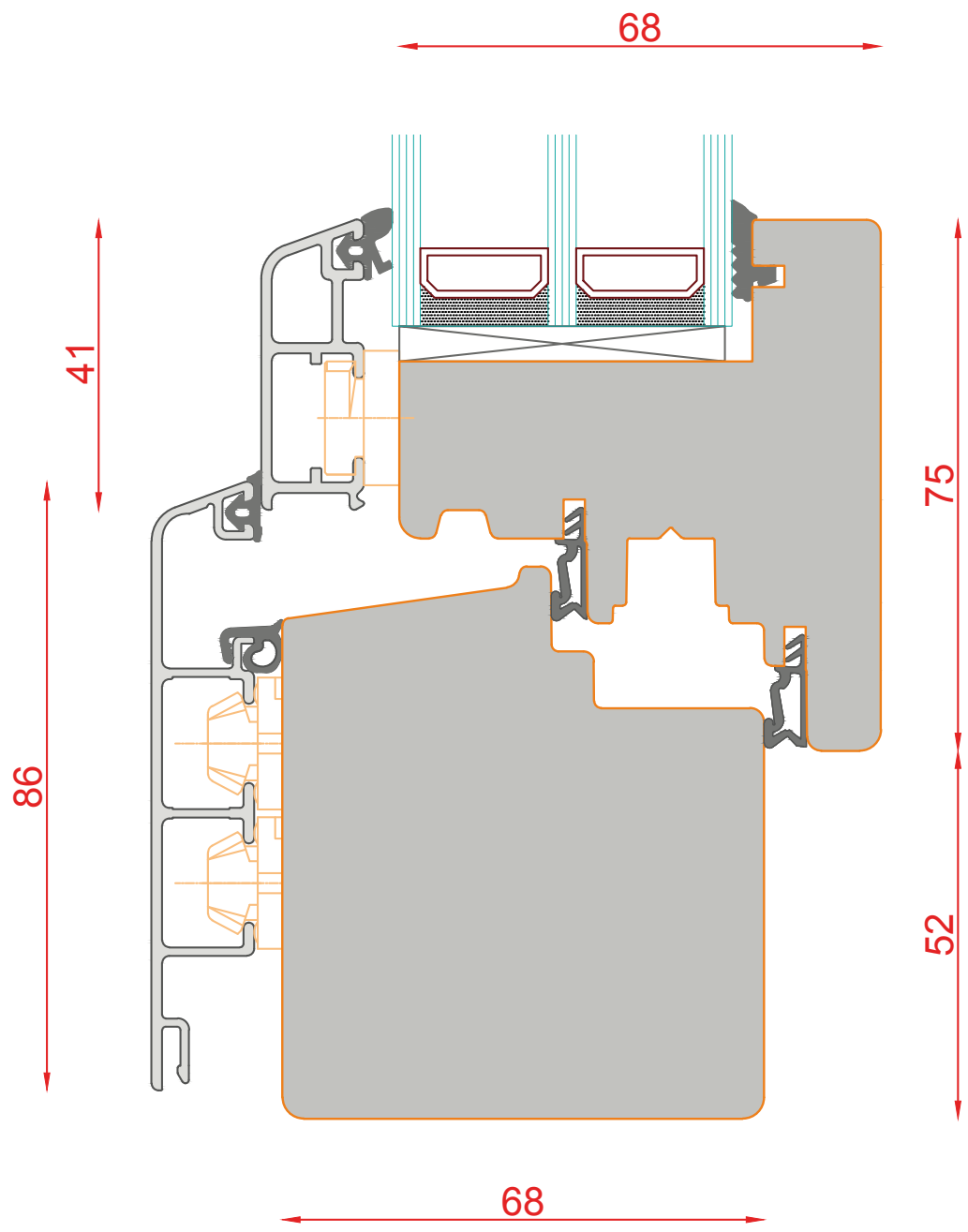
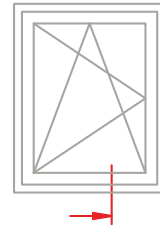

DUO 86

Schnitt : Vertikal unten

Typ: DK

| Seite: 109

SCHMIDT VISBEK
Fenster. Türen. Innenelemente.



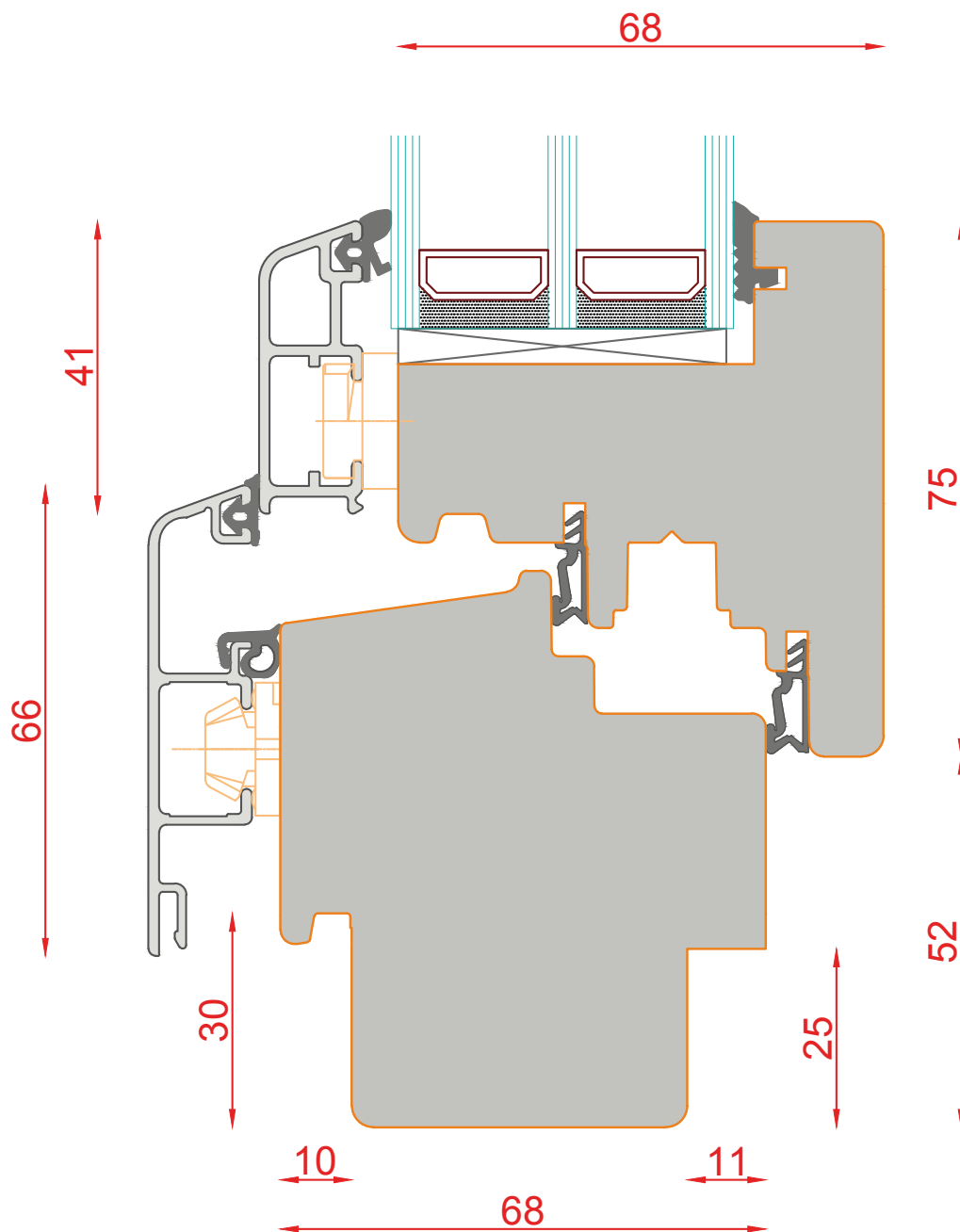
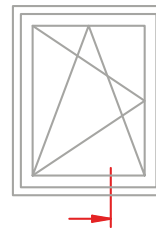

DUO 86

Schnitt : Vertikal unten

Typ: DK mit Fensterbankfalz | Seite: 110

SCHMIDT VISBEK
Fenster · Türen · Innenelemente



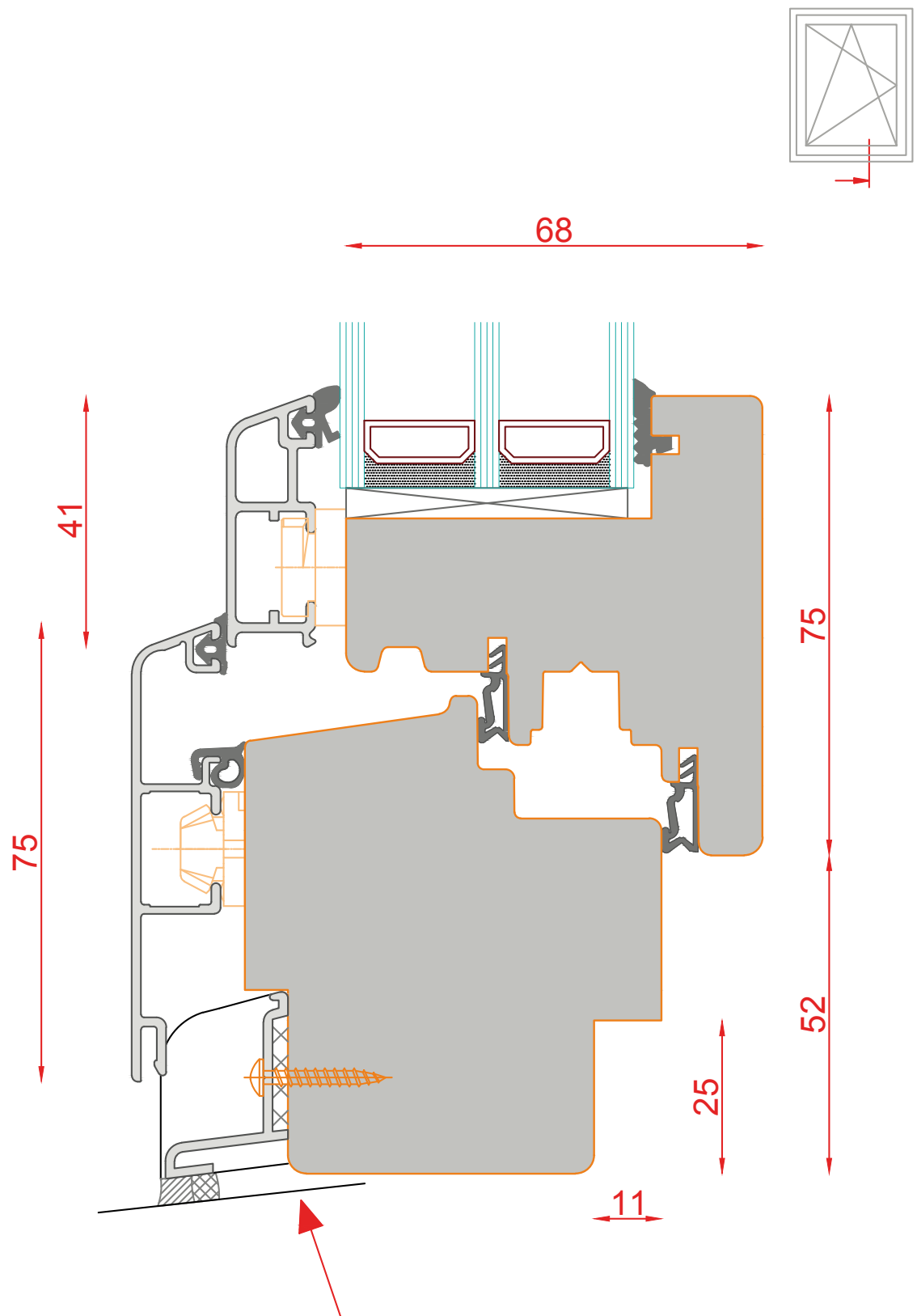

Befestigung Steinbankanschluss optional:

- Sichtbar mit Schraube
- oder angeklebt
- mit Endkappen



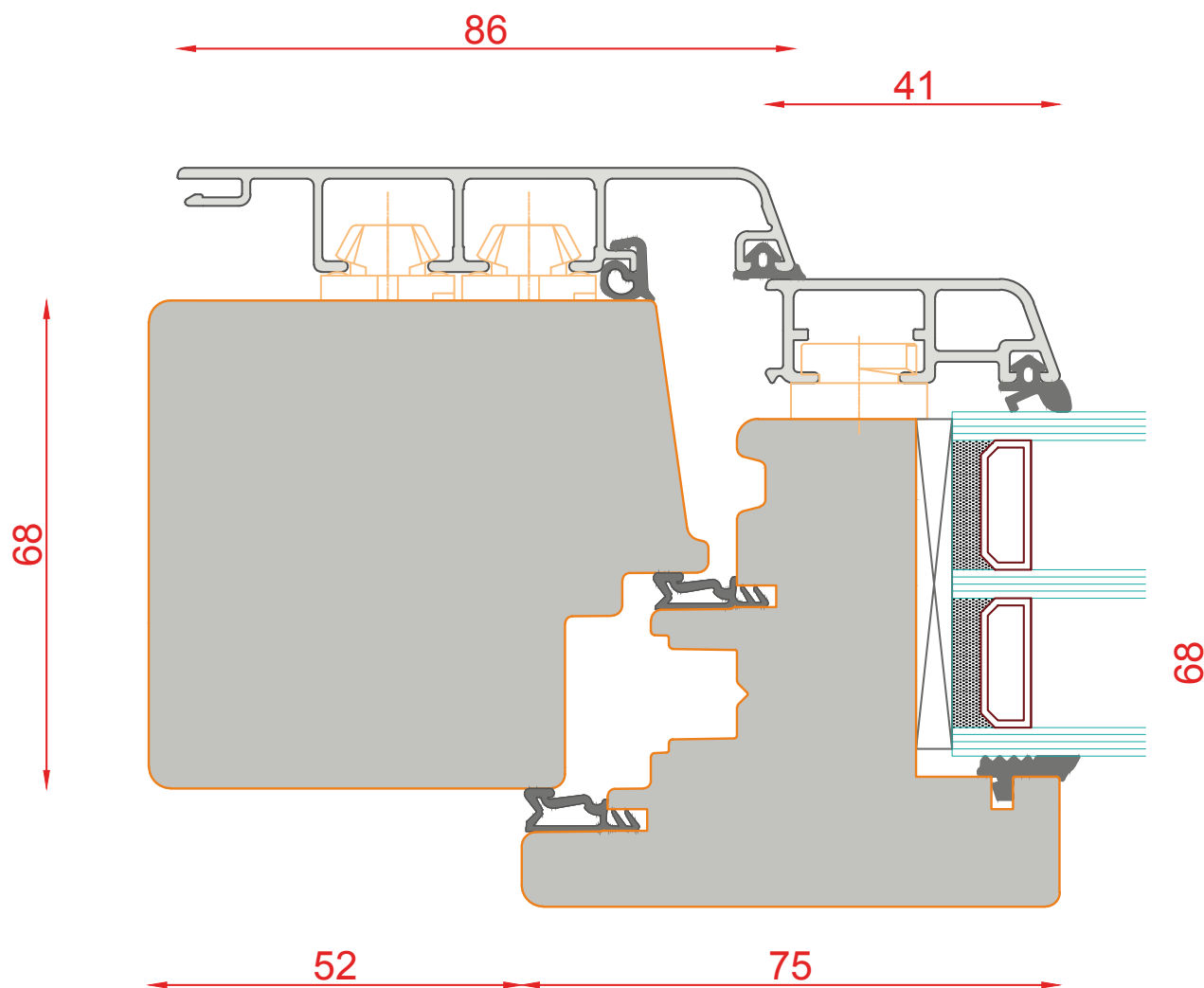
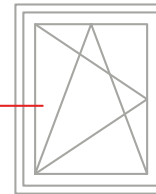

DUO 86

Schnitt : Horizontal seitlich und oben

Typ: DK

| Seite: 112

SCHMIDT VISBEK
Fenster · Türen · Innenelemente

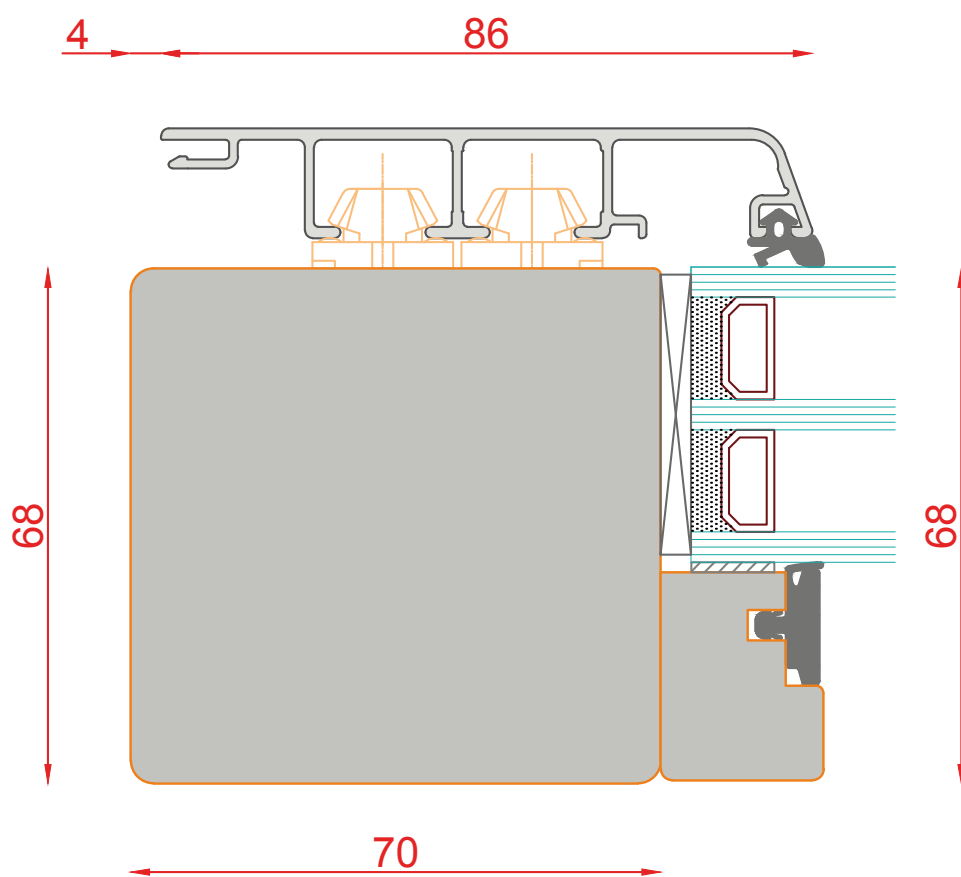
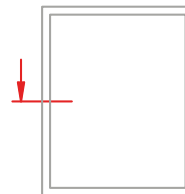

DUO 86

Schnitt : Horizontal seitlich und oben

Typ: FiB

| Seite: 113

SCHMIDT VISBEK
Fenster Türen Innenelemente

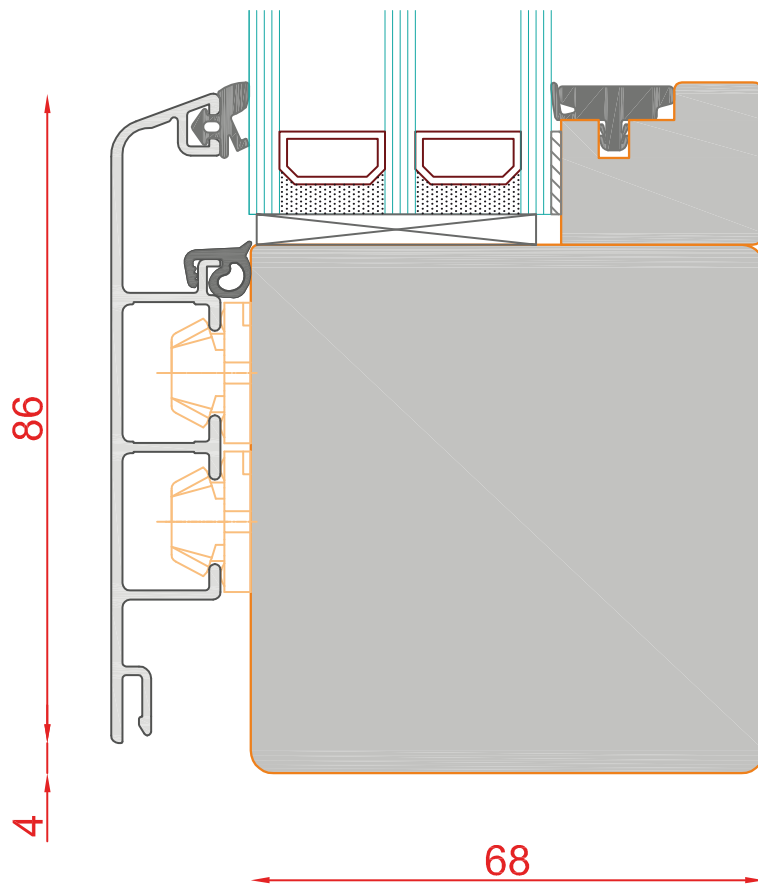
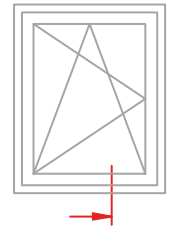

DUO 86

Schnitt : Vertikal unten

Typ: FIB

| Seite: 114

SCHMIDT VISBEK
Fenster. Türen. Innovationen.

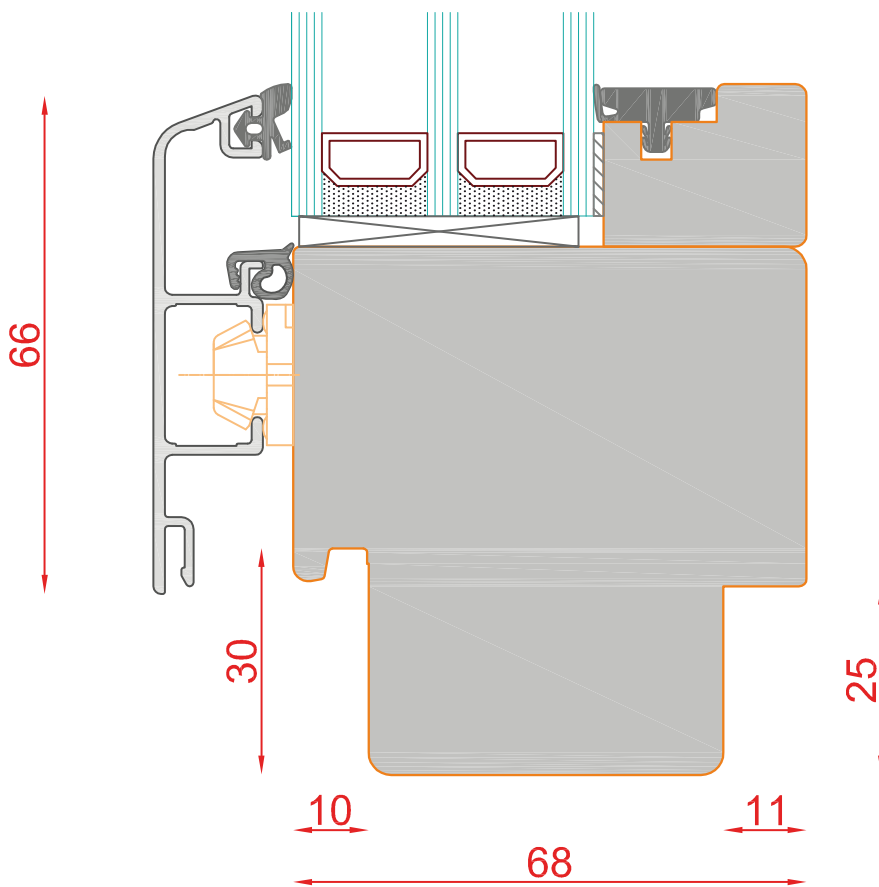
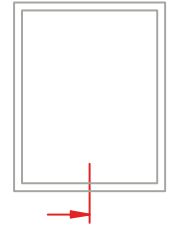

DUO 86

Schnitt : Vertikal unten

Typ: FiB

| Seite: 115

SCHMIDT VISBEK
Fenster. Türen. Innovationen.

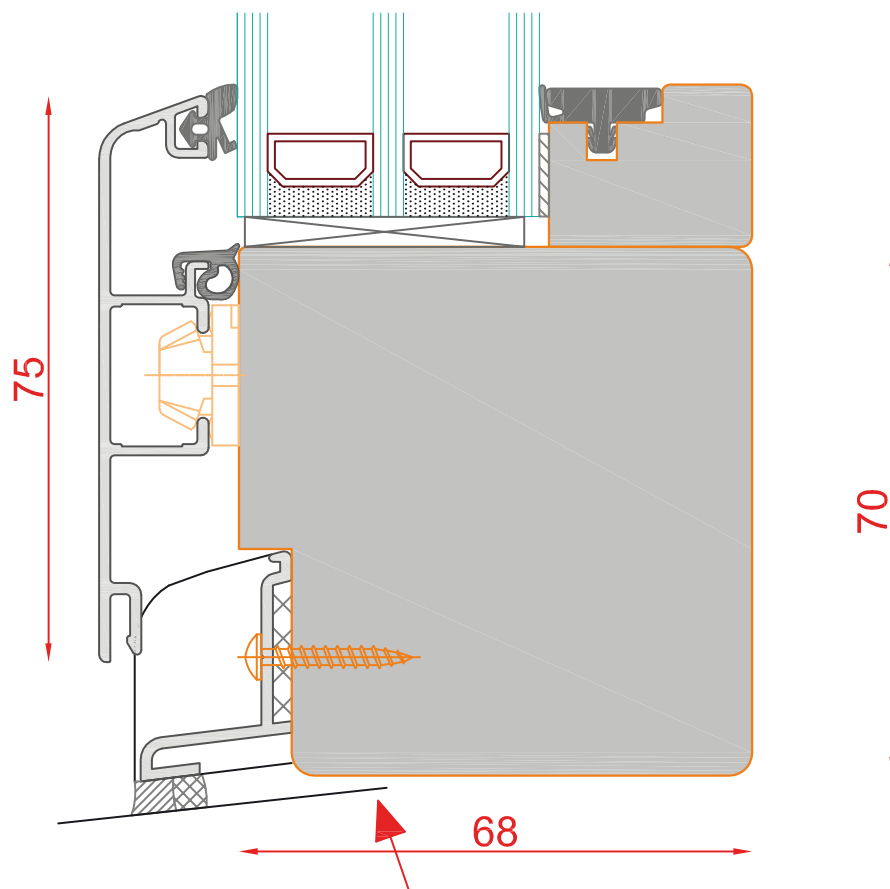
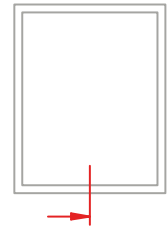

Befestigung Steinbankanschluss optional:

- sichtbar mit Schraube
- oder angeklebt
- mit Endkappen



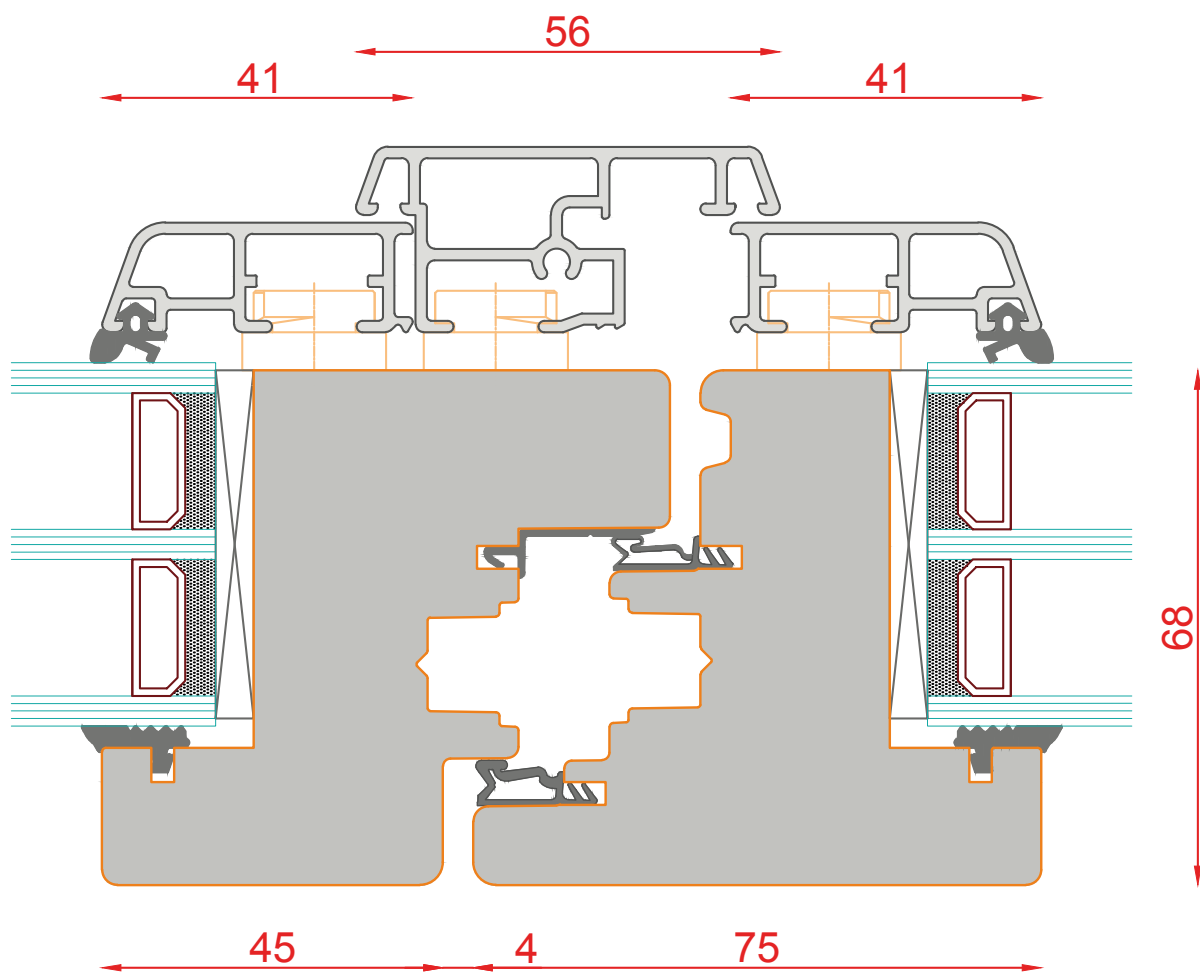
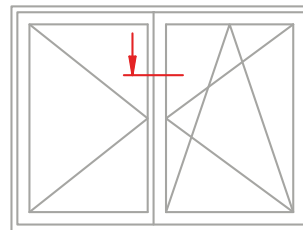

DUO 86

Schnitt : Horizontal Stulp

Typ: DK

| Seite: 117

SCHMIDT VISBEK
Fenster, Türen, Innenelemente.

110

41

68

75

34

75

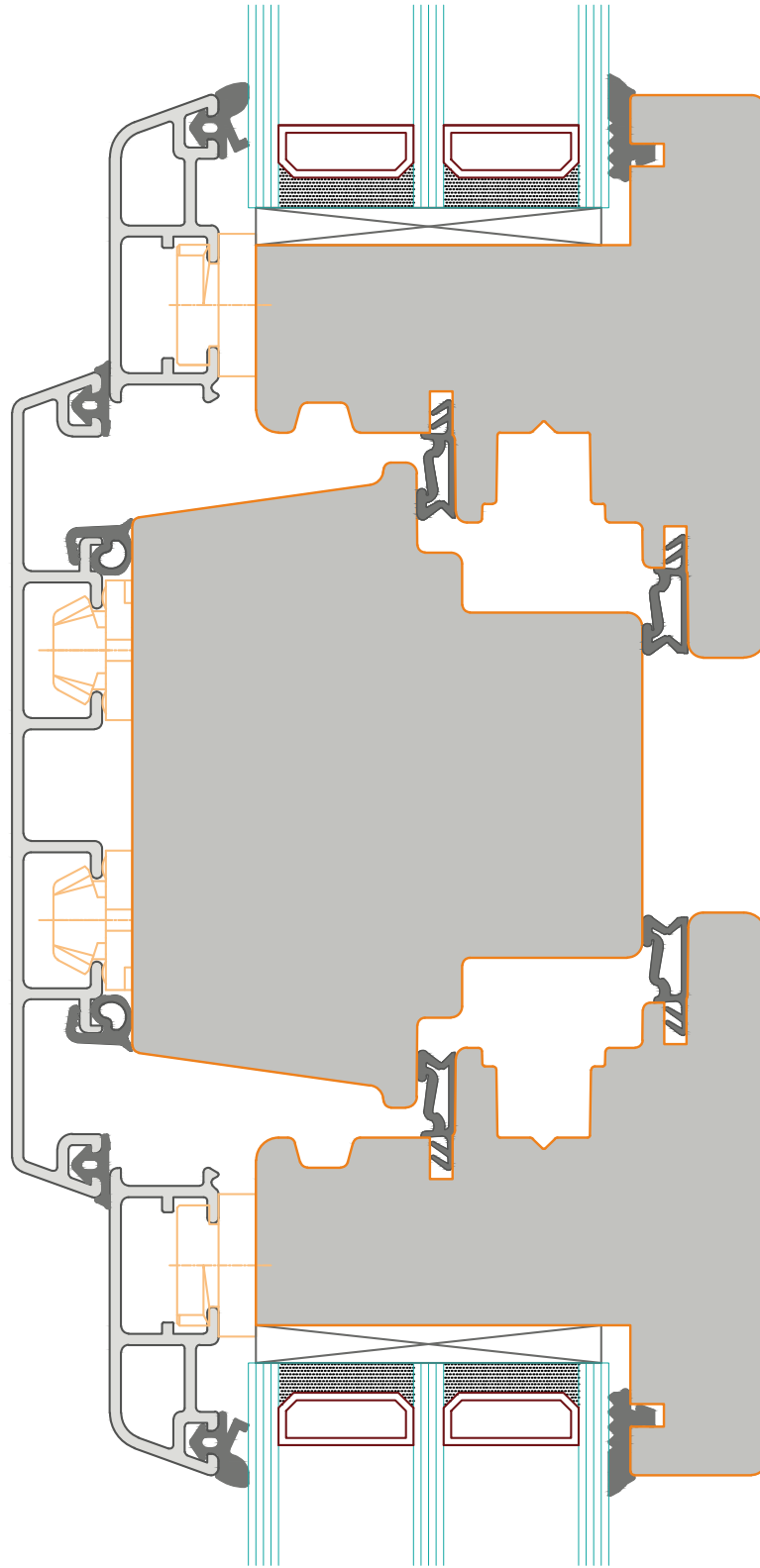
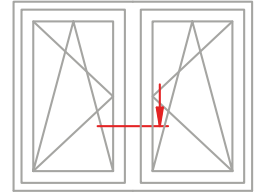

DUO 86

Schnitt : Horizontal Mitte Pfosten

Typ: DK mit Mittelpfosten

| Seite: 118

SCHMIDT VISBEK

Fenster · Türen · Innenrollläden



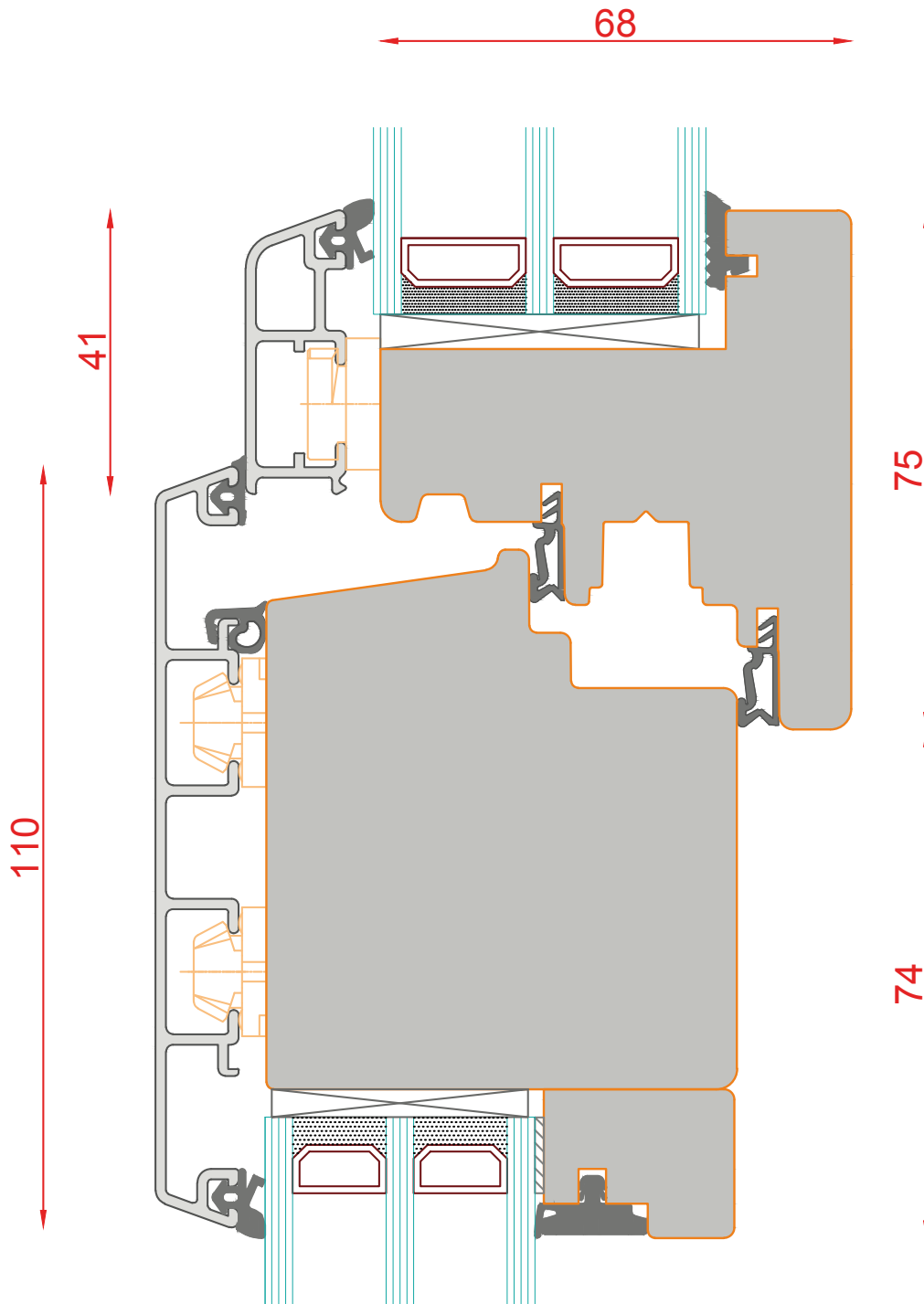
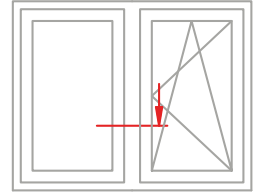

DUO 86

Schnitt : Horizontal Mitte

Typ: DK - FIB

| Seite: 119

SCHMIDT VISBEK
FENSTER. TÜREN. INNOVATIONEN.

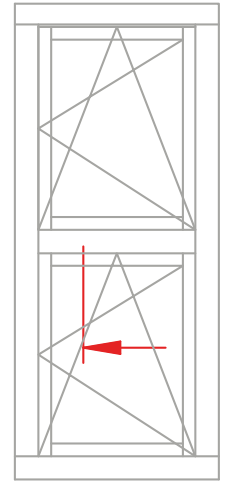
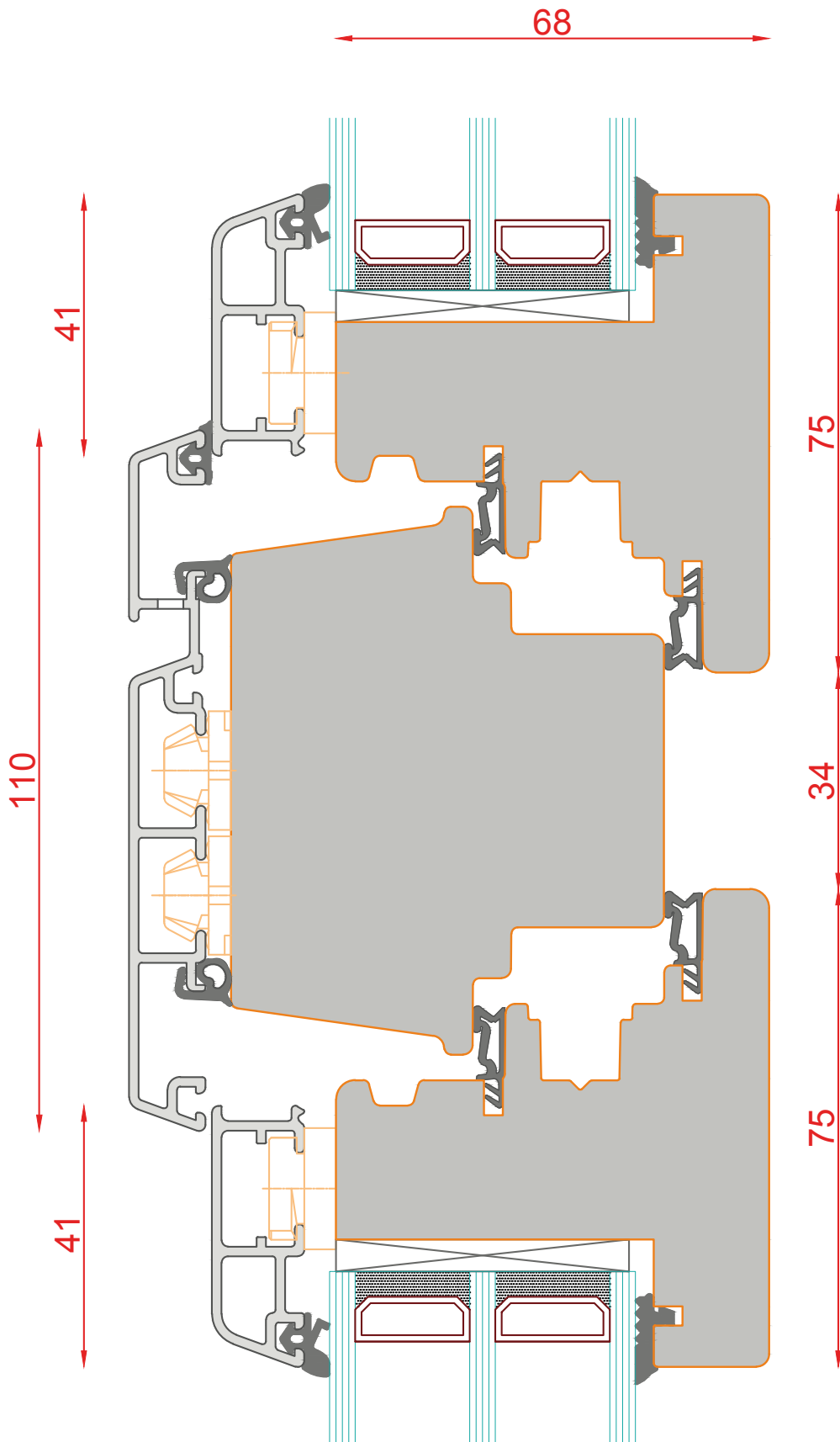

DUO 86

Schnitt : Vertikal

Typ: Kämpfer DK - DK

| Seite: 120



SCHMIDT VISBEK

Fenster, Türen, Innenelemente.

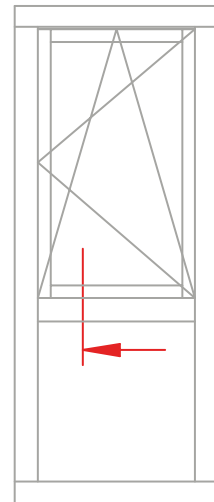
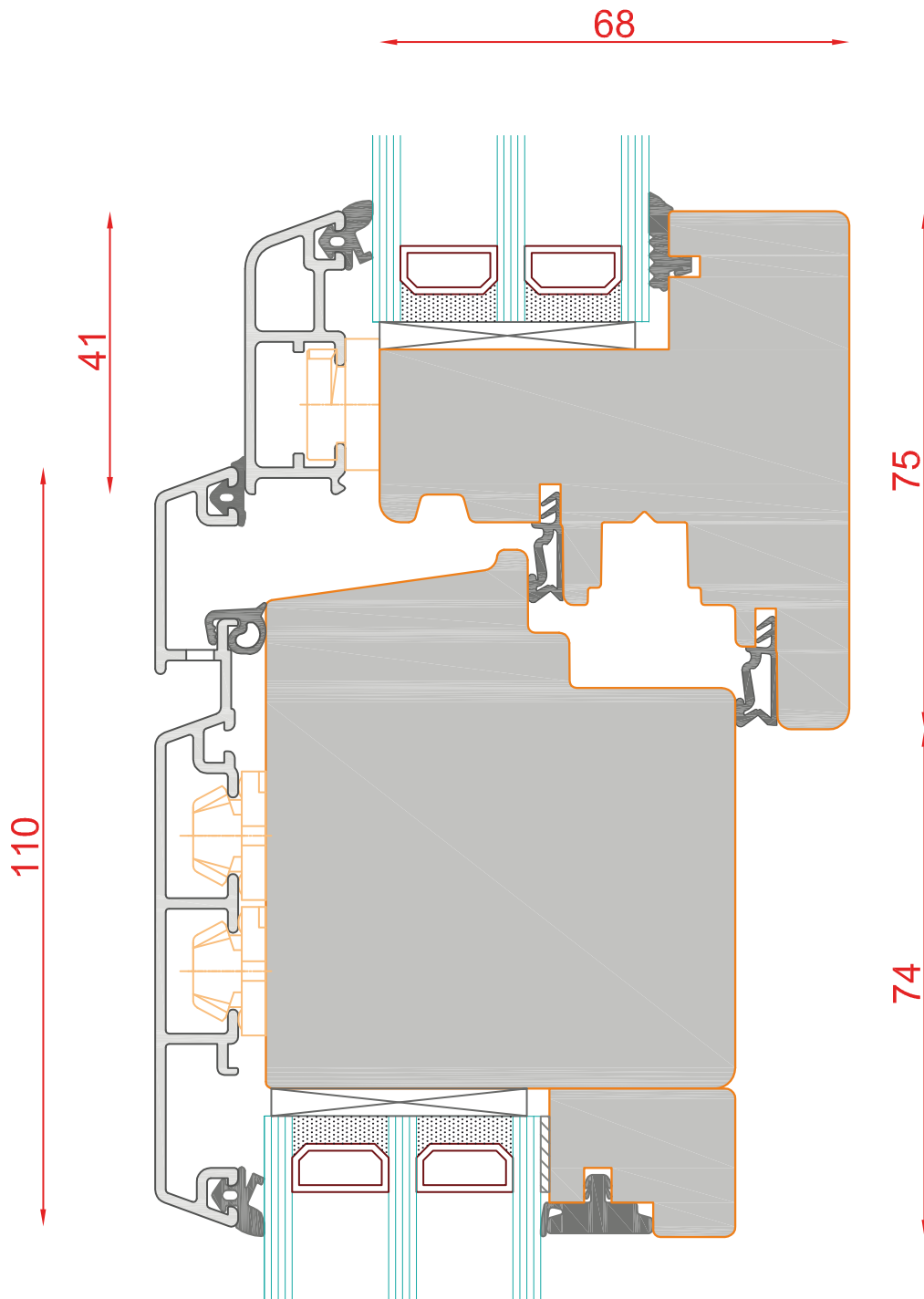

DUO 86

Schnitt : Vertikal Kämpfer DK-FIB

Typ: FiB

| Seite: 121

SCHMIDT VISBEK
Fenster. Türen. Innovationen.

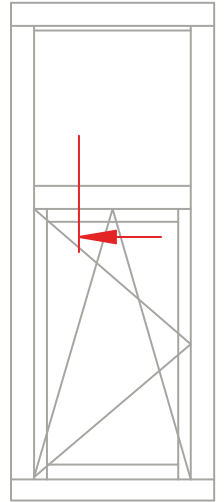
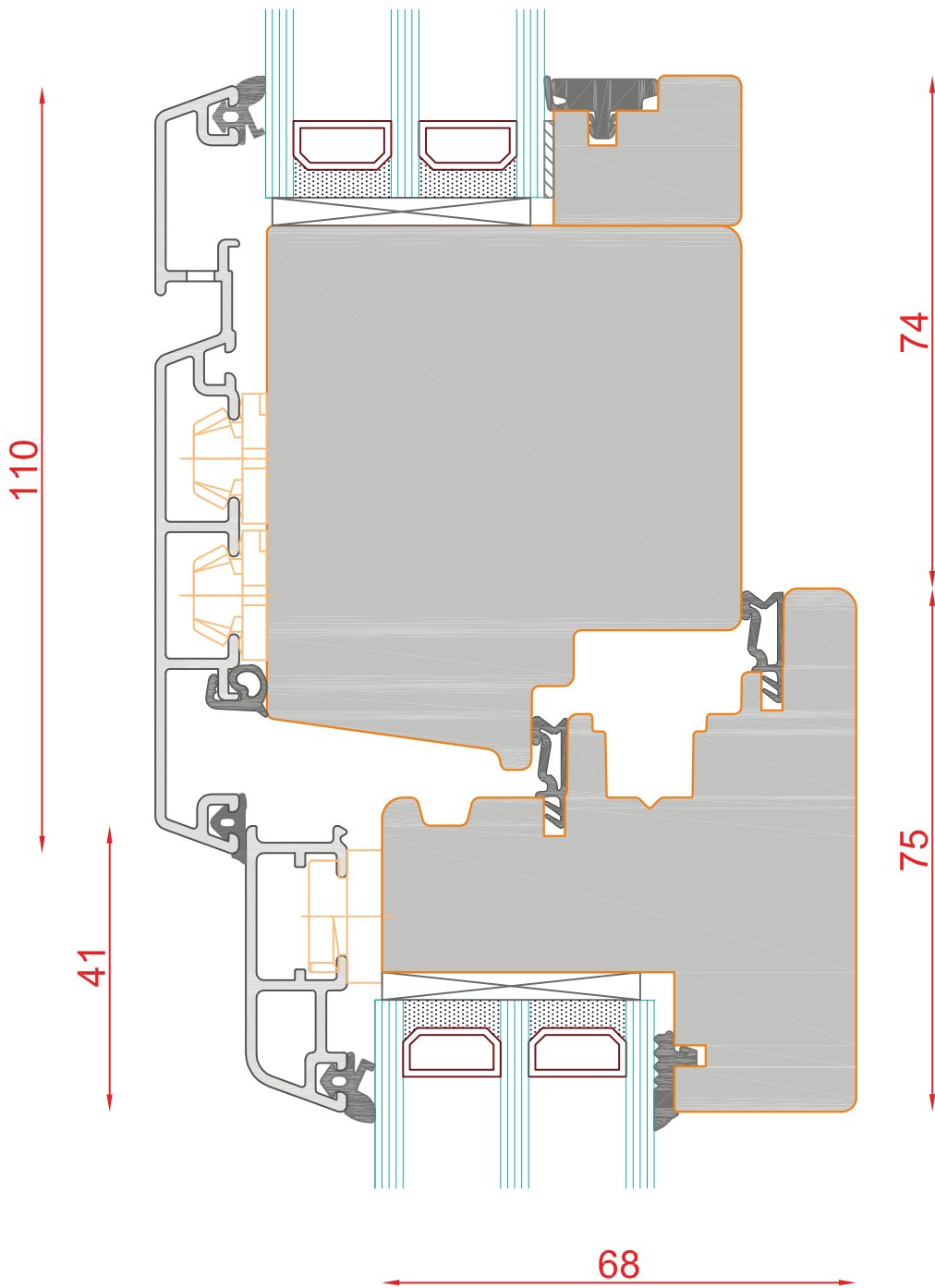

DUO 86

Schnitt : Vertikal Kämpfer DK-FIB

Typ: FiB

| Seite: 122

SCHMIDT VISBEK
Fenster. Türen. Innovationen.

110

41

68

75

74

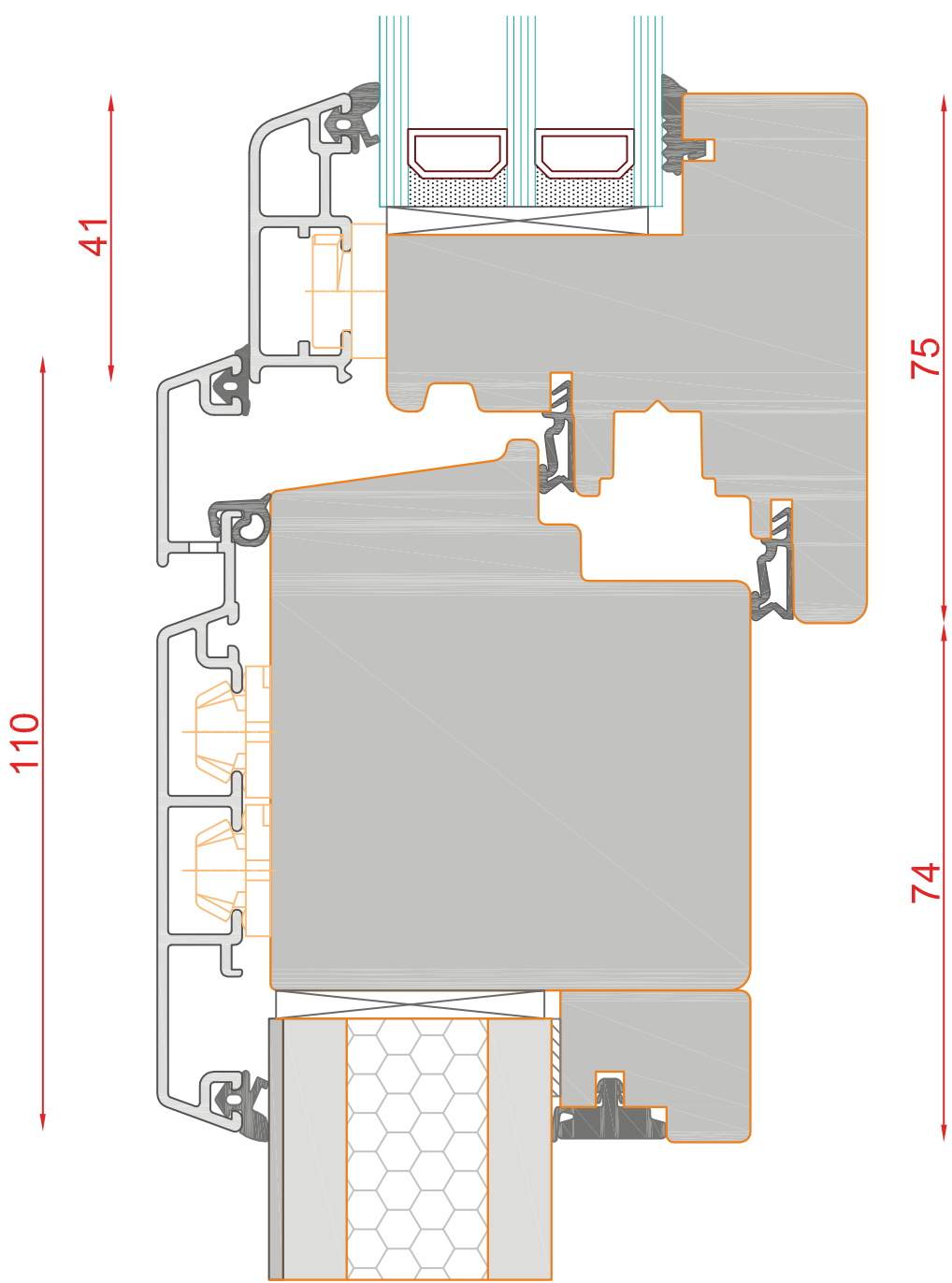

DUO 86

Schnitt : Vertikal Kämpfer DK-FIB

Typ: Füllung

| Seite: 123

SCHMIDT VISBEK
 Fenster. Türen. Innovationen.

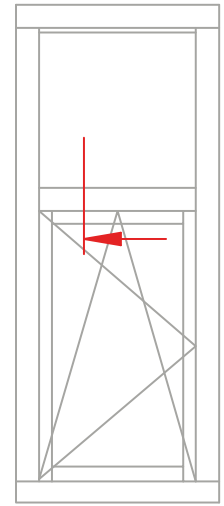
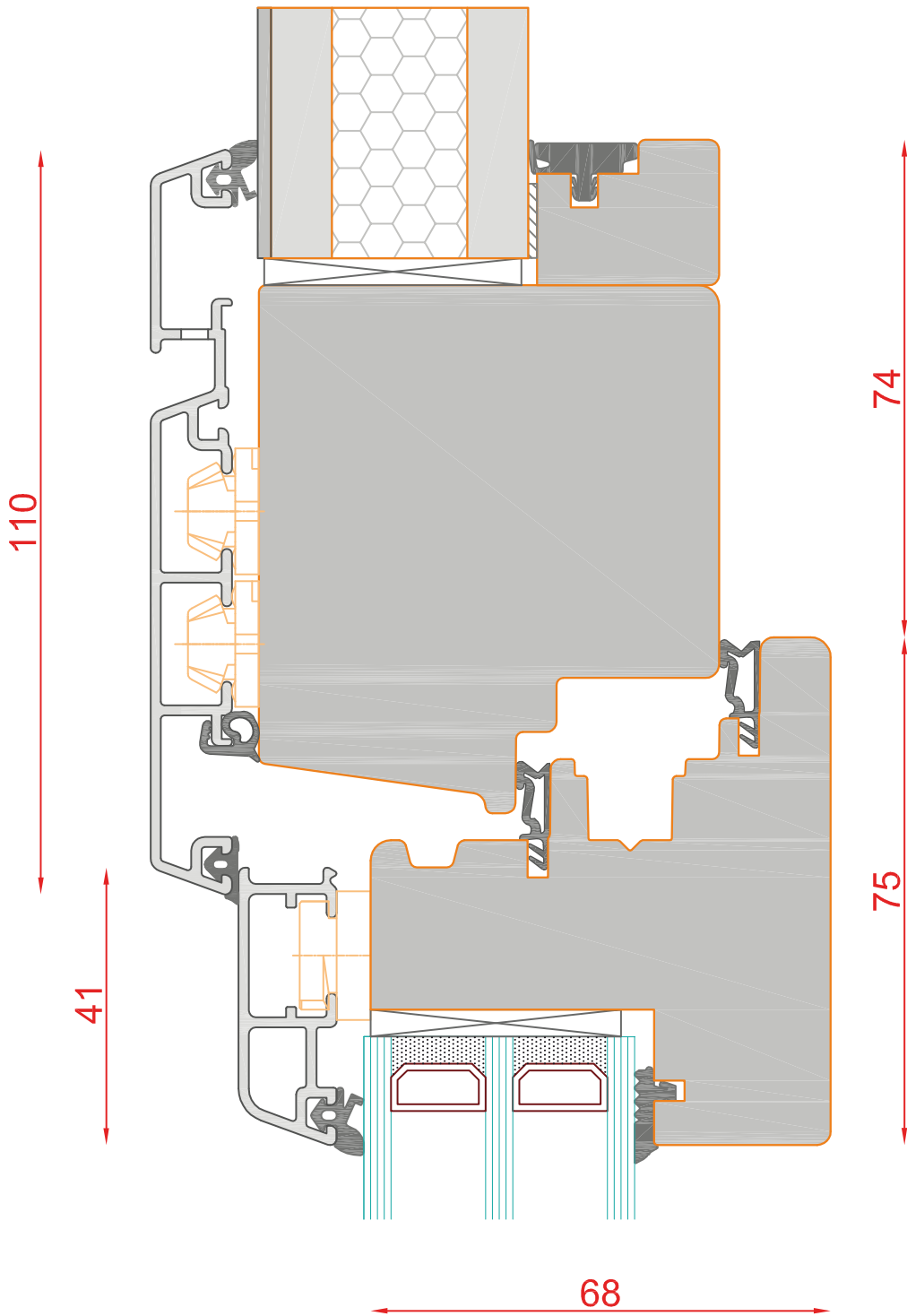

DUO 86

Schnitt : Vertikal Kämpfer DK-FIB

Typ: Füllung

| Seite: 124



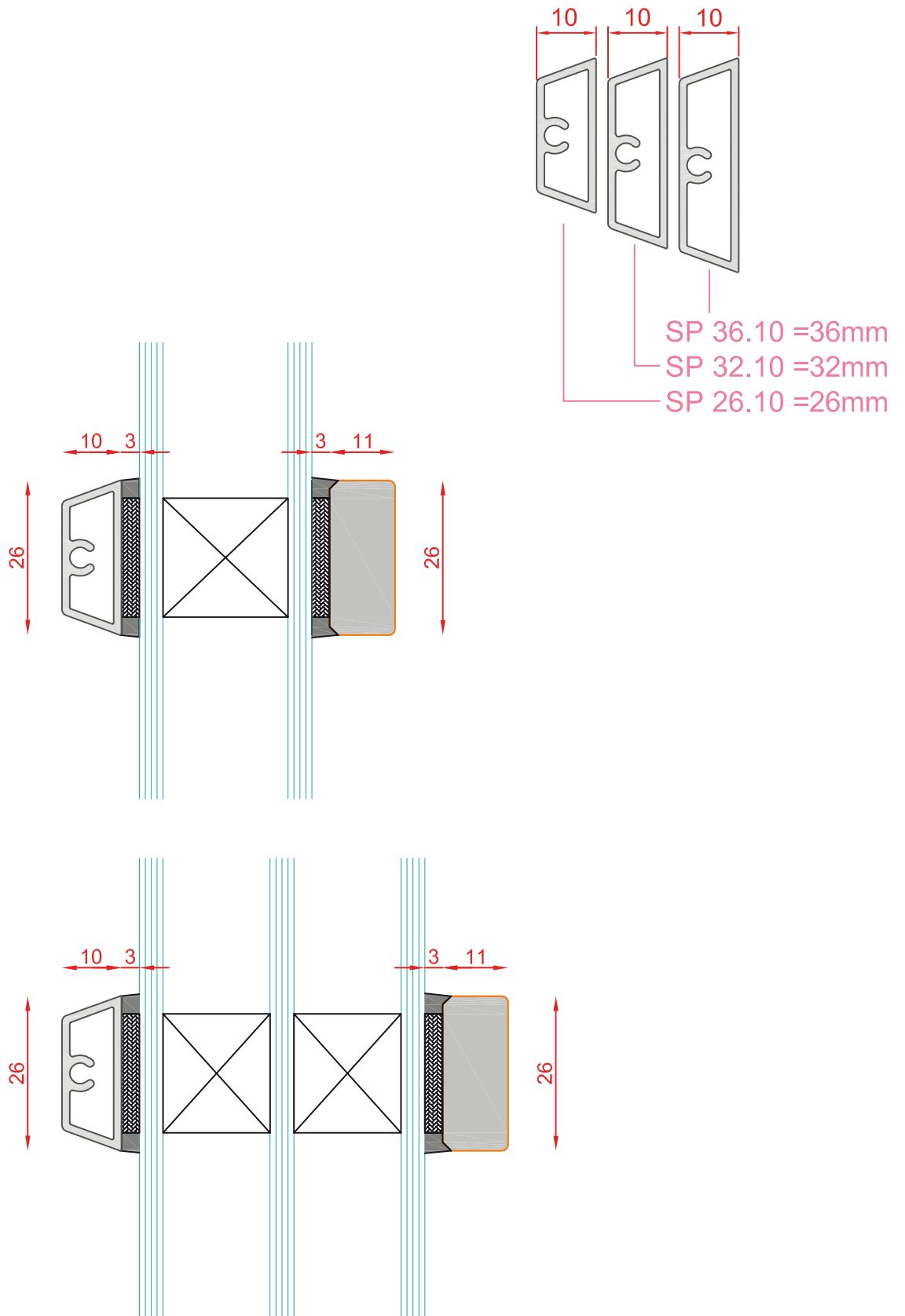

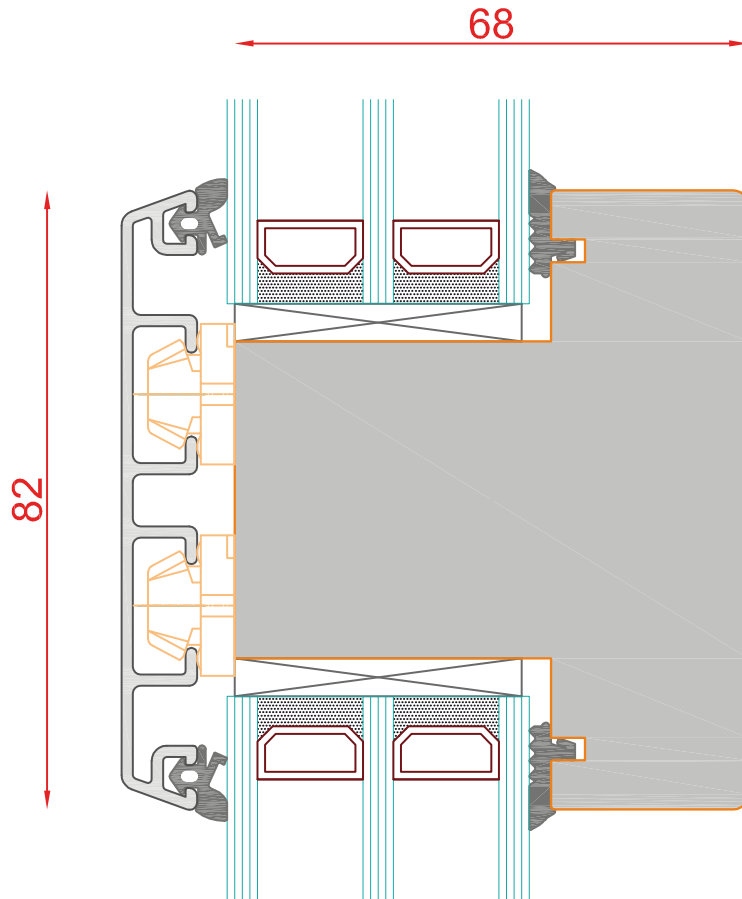
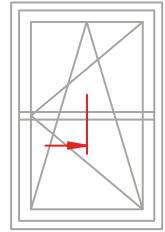

DUO 86

Schnitt : Sprosse Glasteilend

Typ: Flügel

| Seite: 126



SCHMIDT VISBEK
Fenster. Türen. Innovationen.

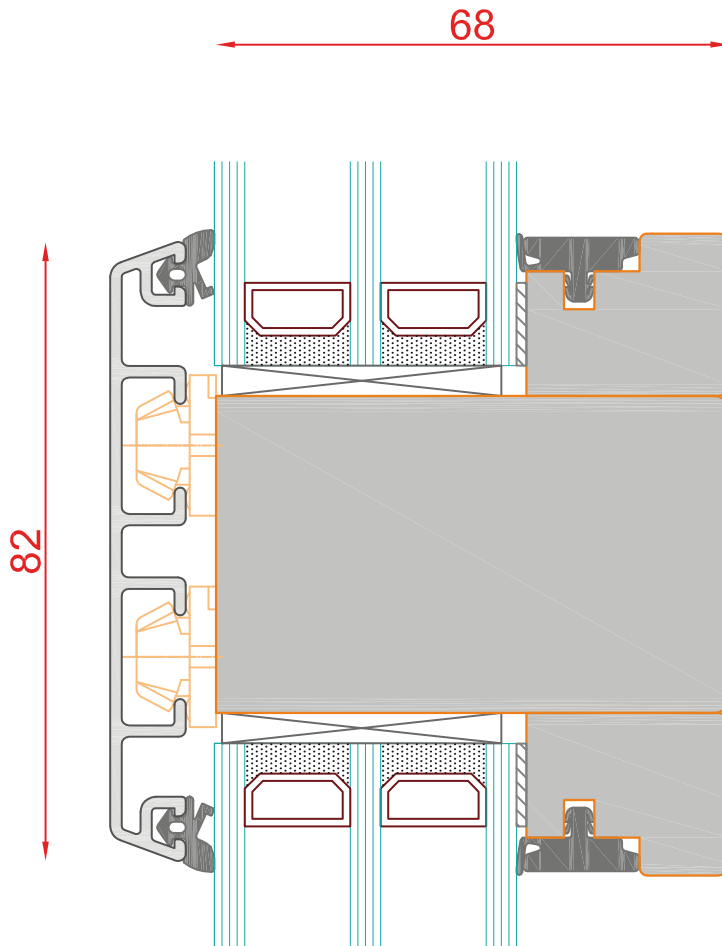
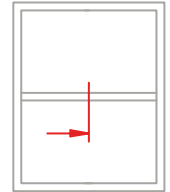

DUO 86

Schnitt : Sprosse Glasteilend

Typ: Blendrahmen

| Seite: 127



SCHMIDT VISBEK
Fenster. Türen. Innovationen.

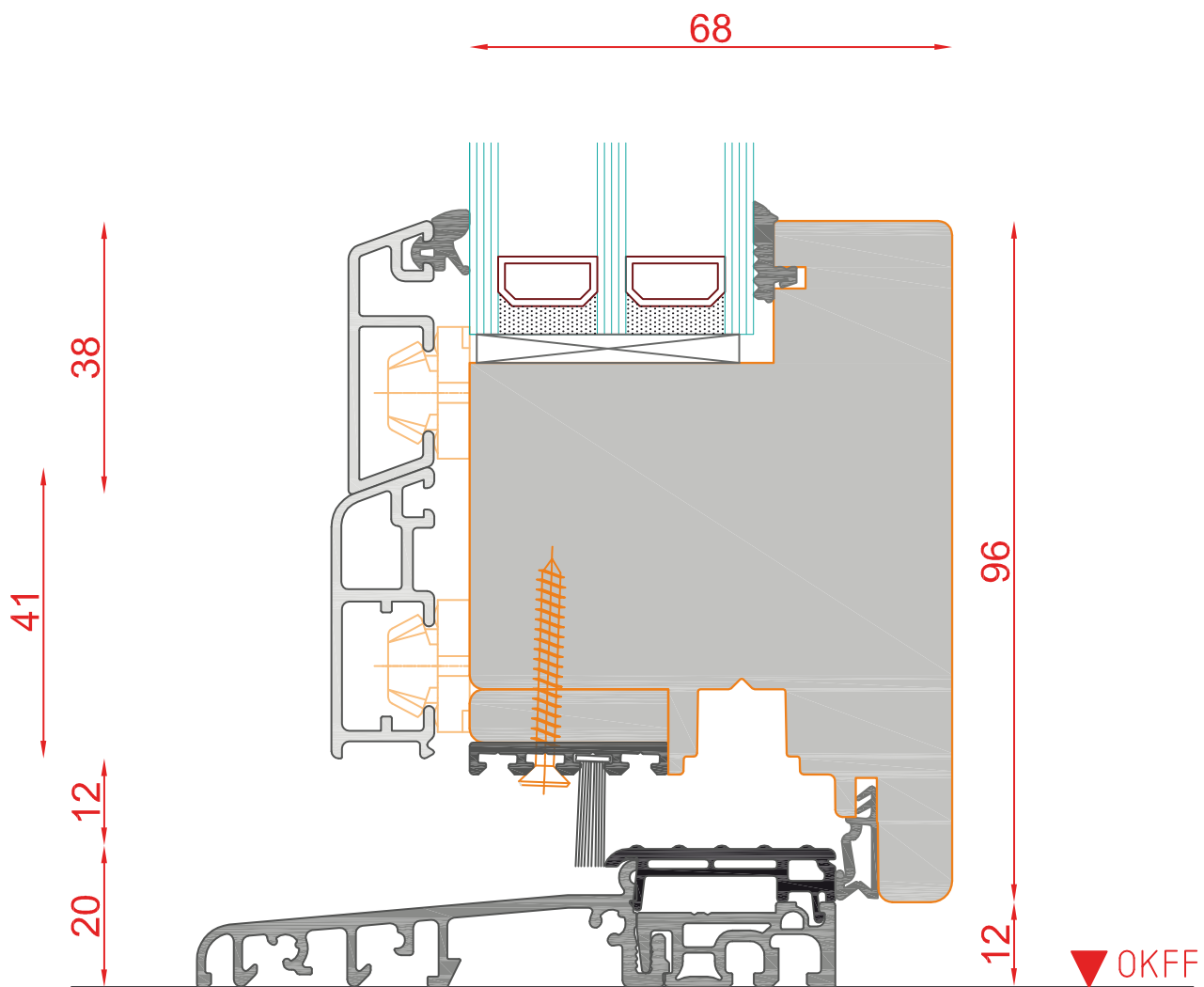
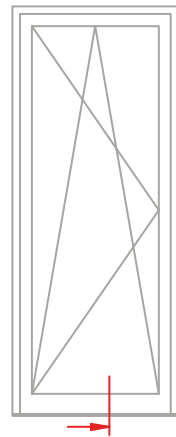

Bodenschwelle BKV Eifel 90 TB



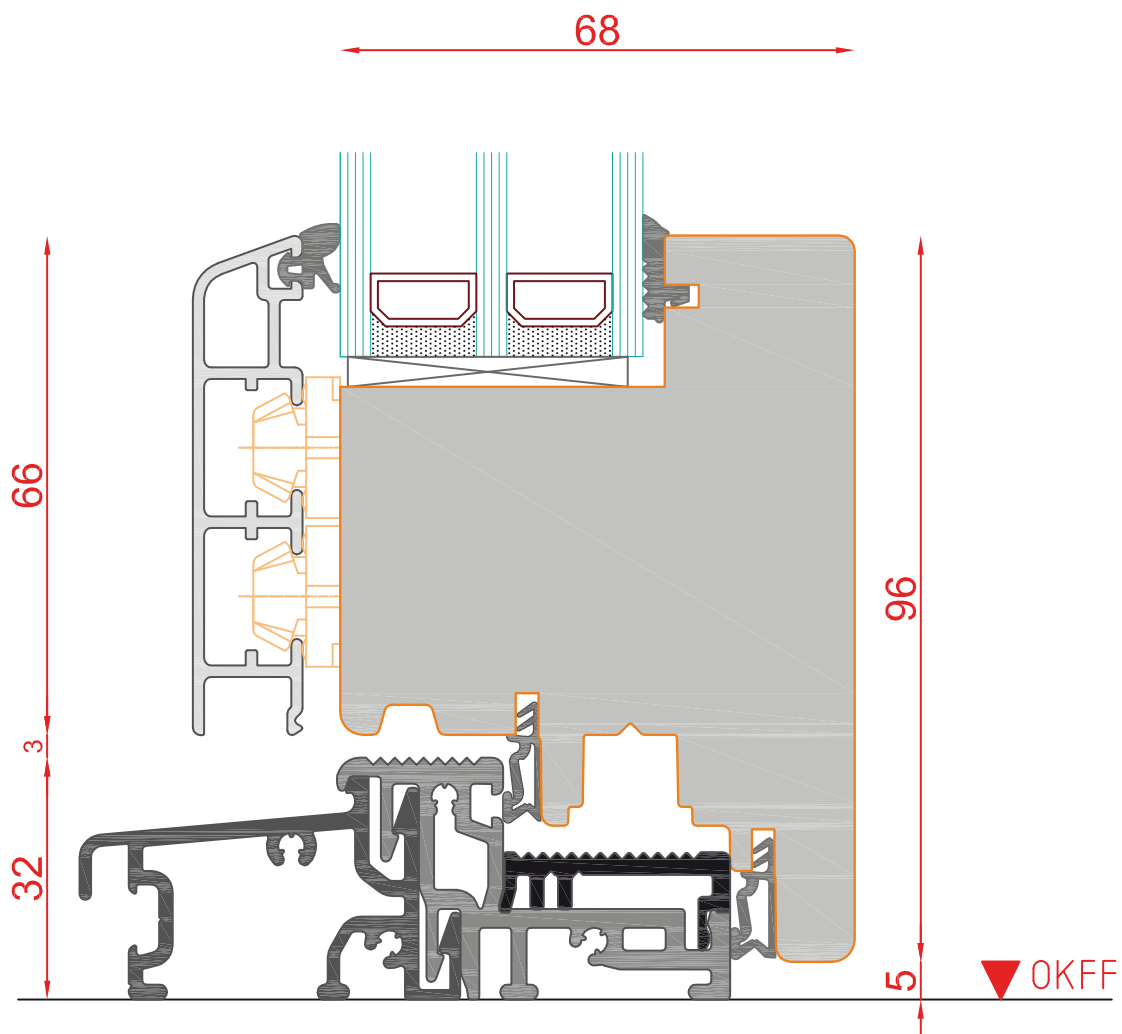
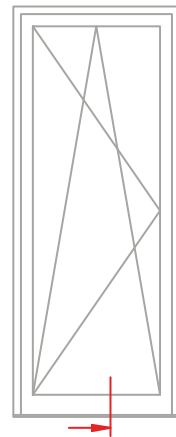

Bodenschwelle Weser 86/32 Ti



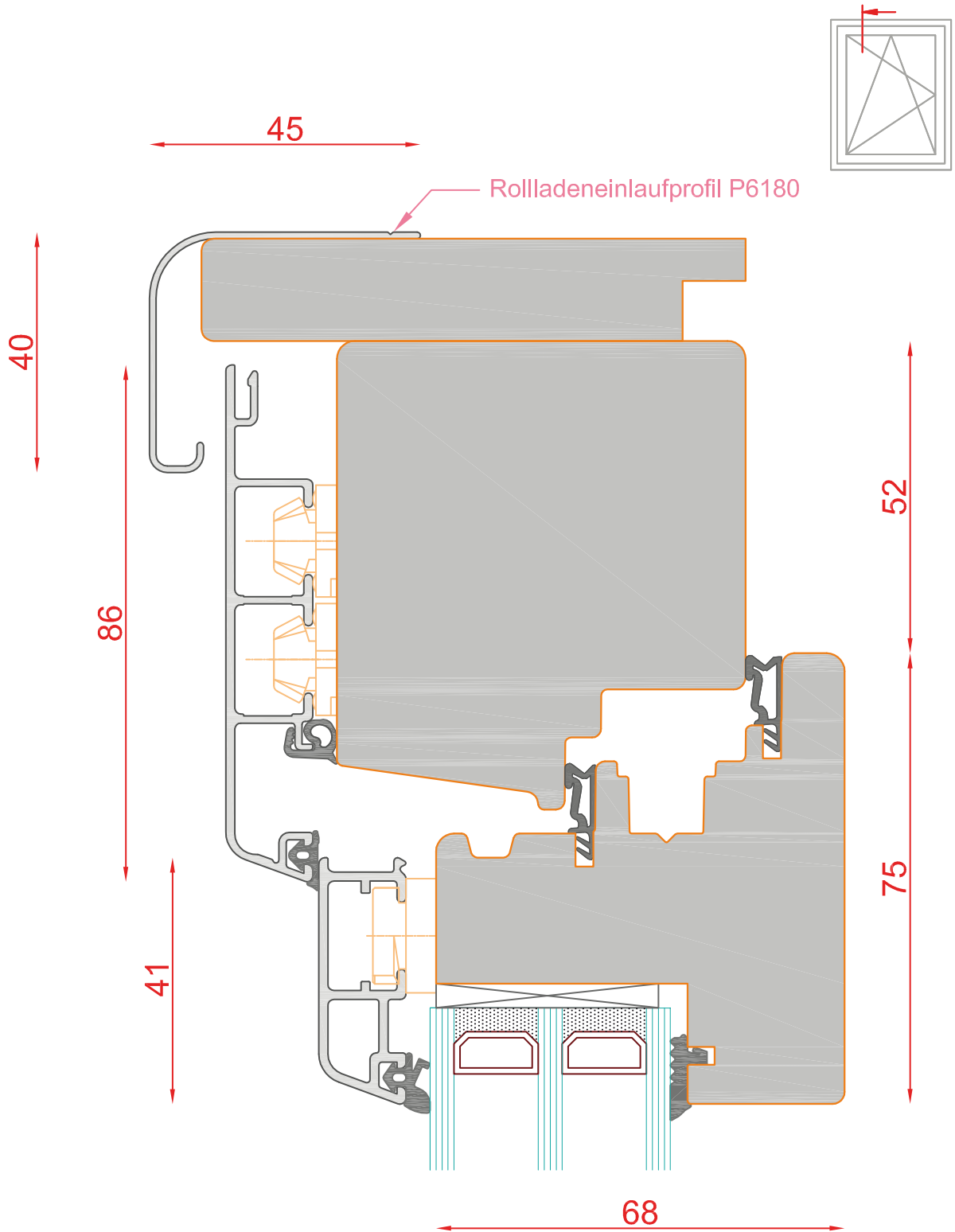

DUO 86

Schnitt : Horizontal seitlich und oben

Typ: DK

| Seite: 130



SCHMIDT VISBEK
Fenster. Türen. Innovationen.

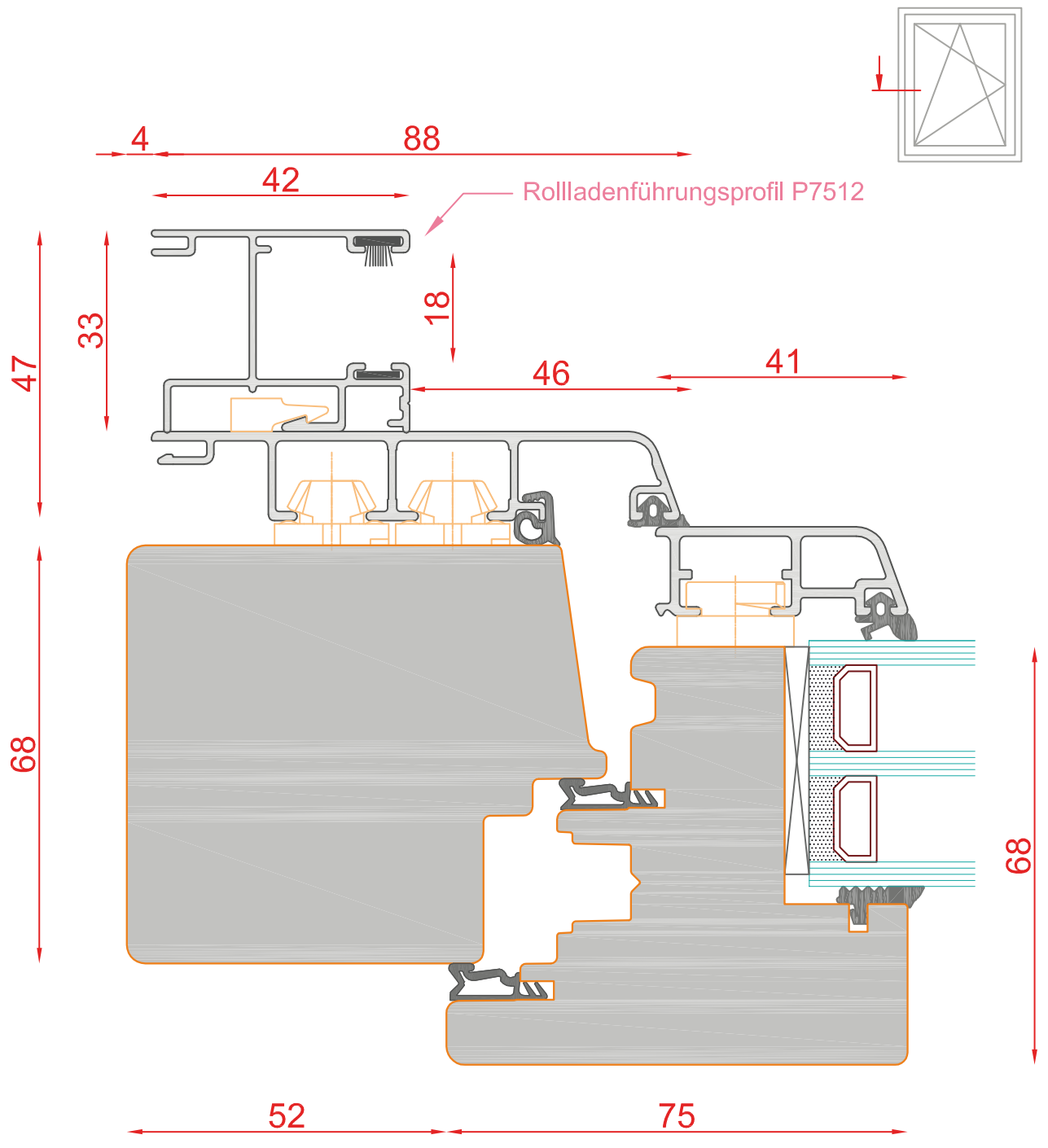

DUO 86

Schnitt : Horizontal seitlich und oben

Typ: DK

| Seite: 131

SCHMIDT VISBEK
Fenster. Türen. Innovationen.

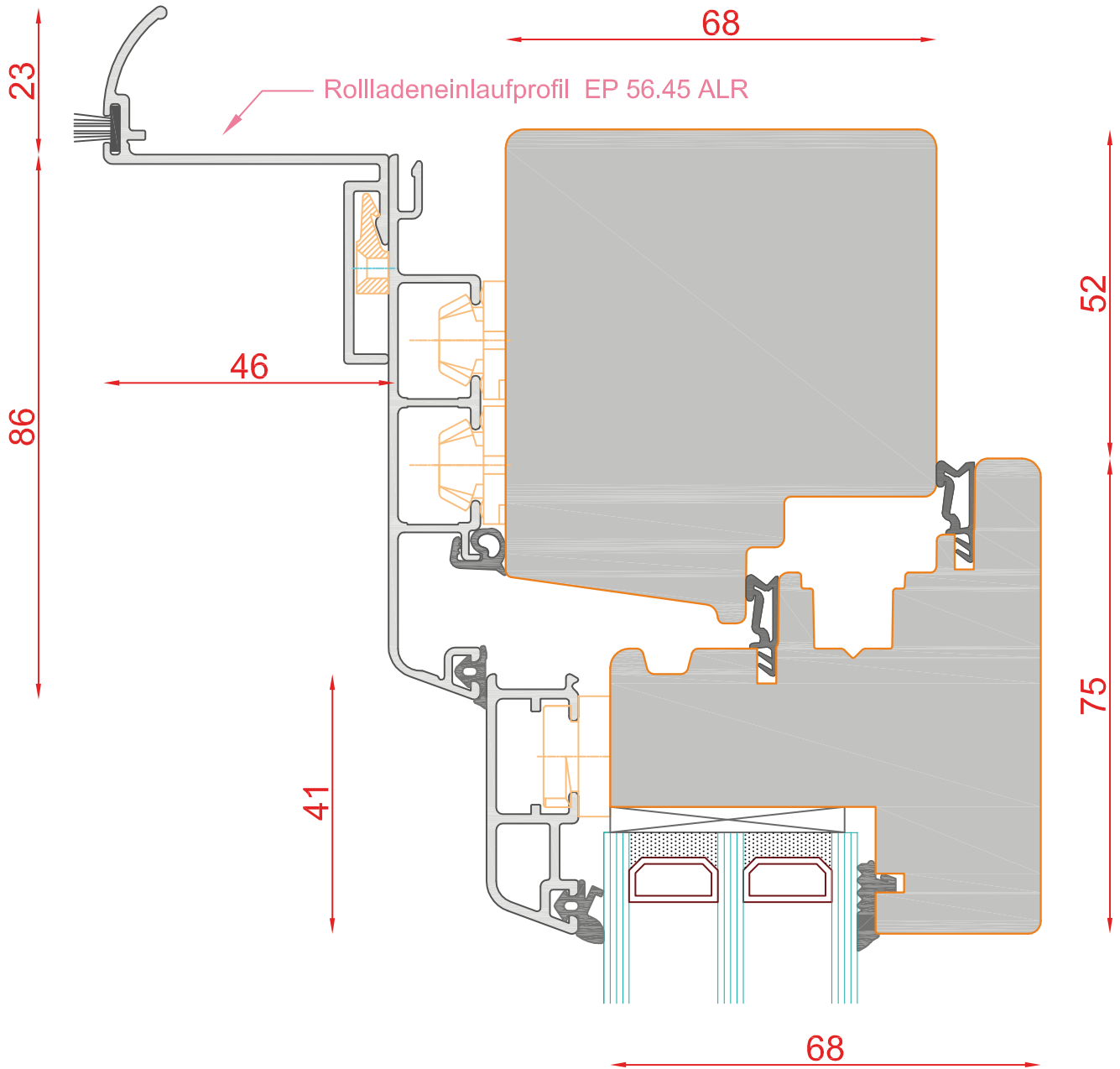
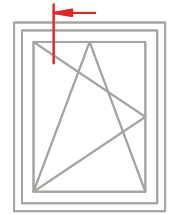

DUO 86

Schnitt : Horizontal seitlich und oben

Typ: DK

| Seite: 132

SCHMIDT VISBEK
Fenster. Türen. Innovationen.

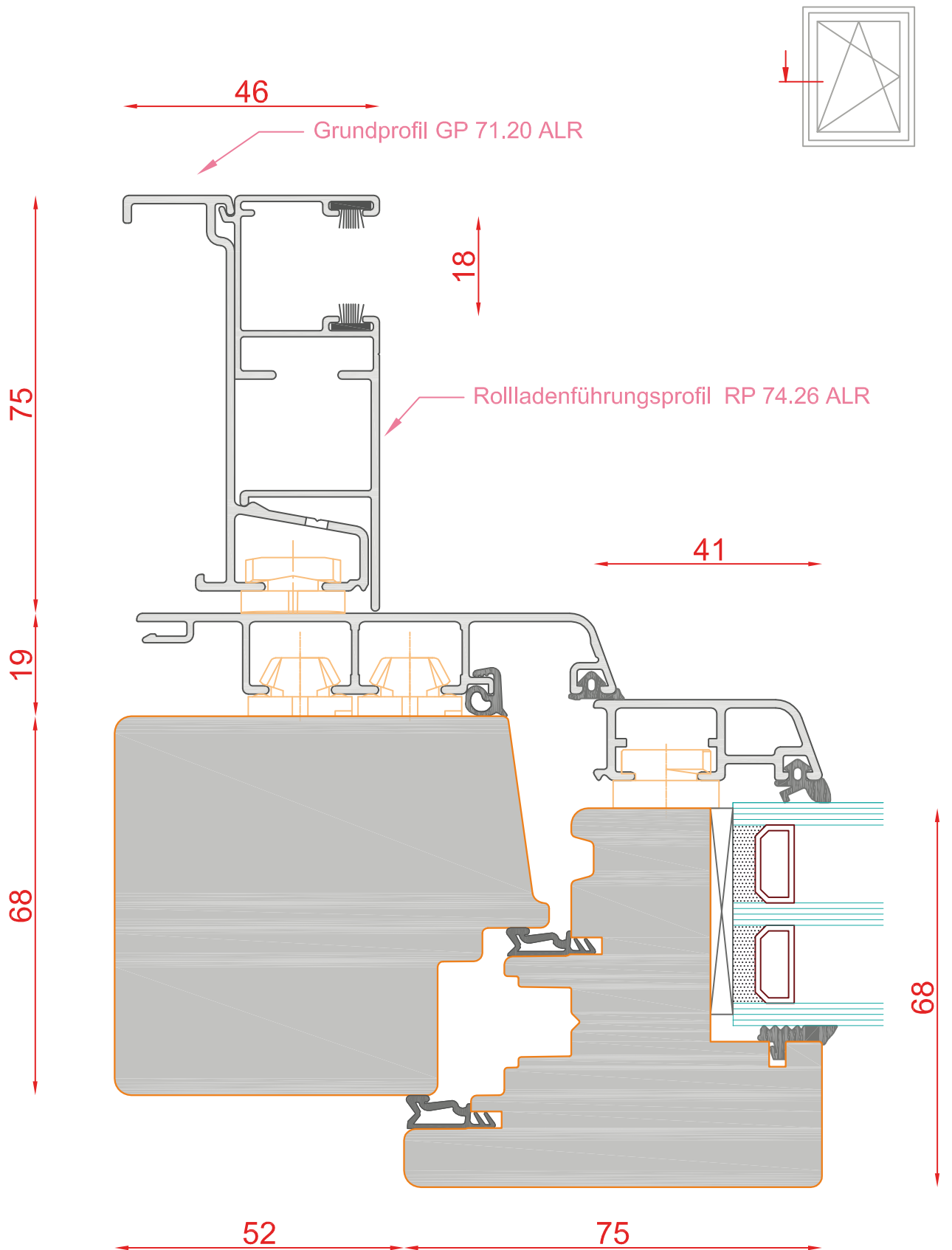

DUO 86

Schnitt : Horizontal seitlich und oben

Typ: DK

| Seite: 133

SCHMIDT VISBEK
Fenster. Türen. Innovationen.

DUO 96

mit Mira-Schalen

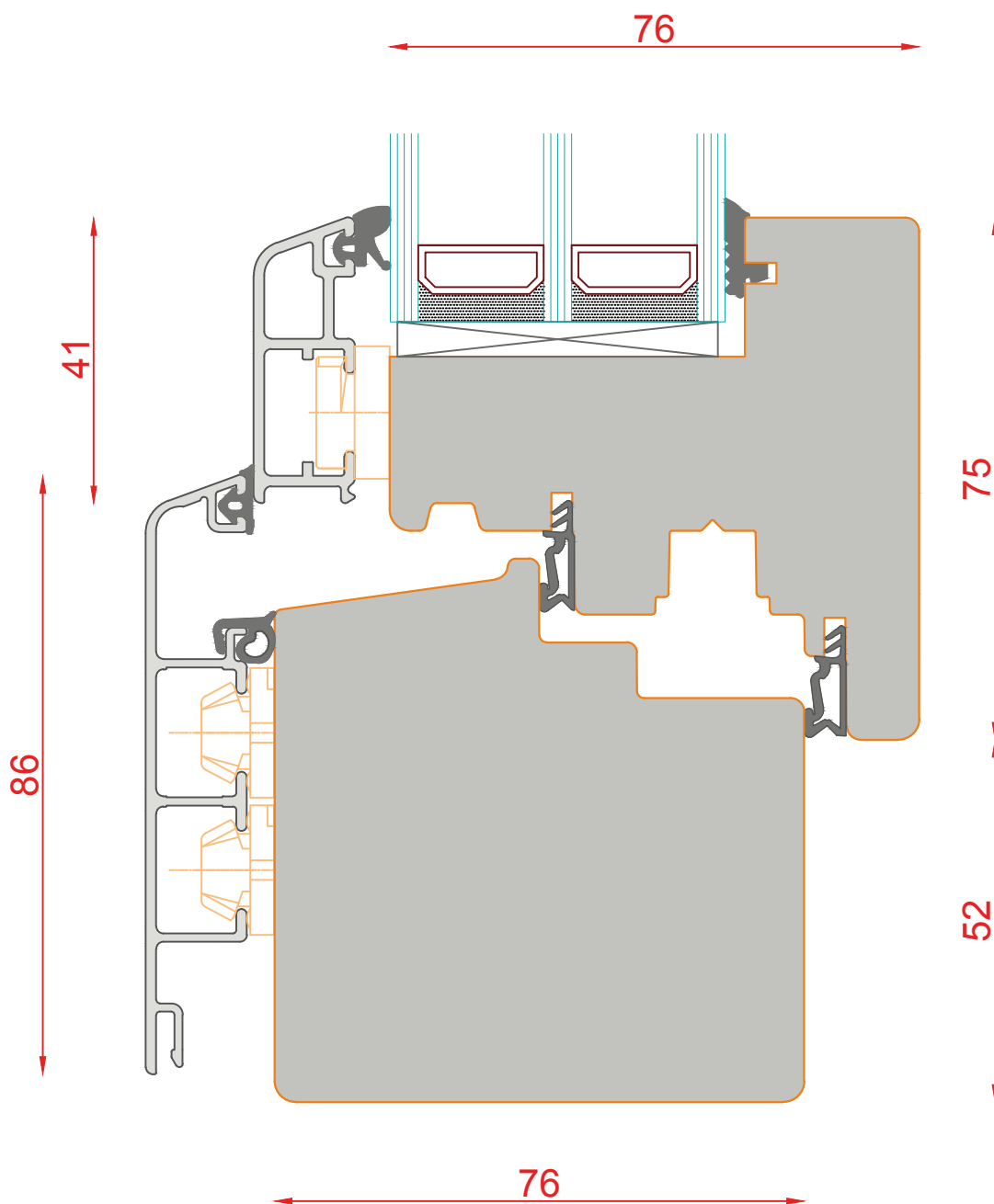
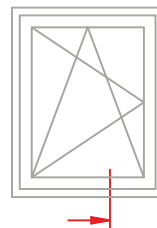

DUO 96
MIT MIRA-SCHALEN

Schnitt : Vertikal unten

Typ: DK

| Seite: 135

SCHMIDT VISBEK
Fenster, Türen, Innenelemente

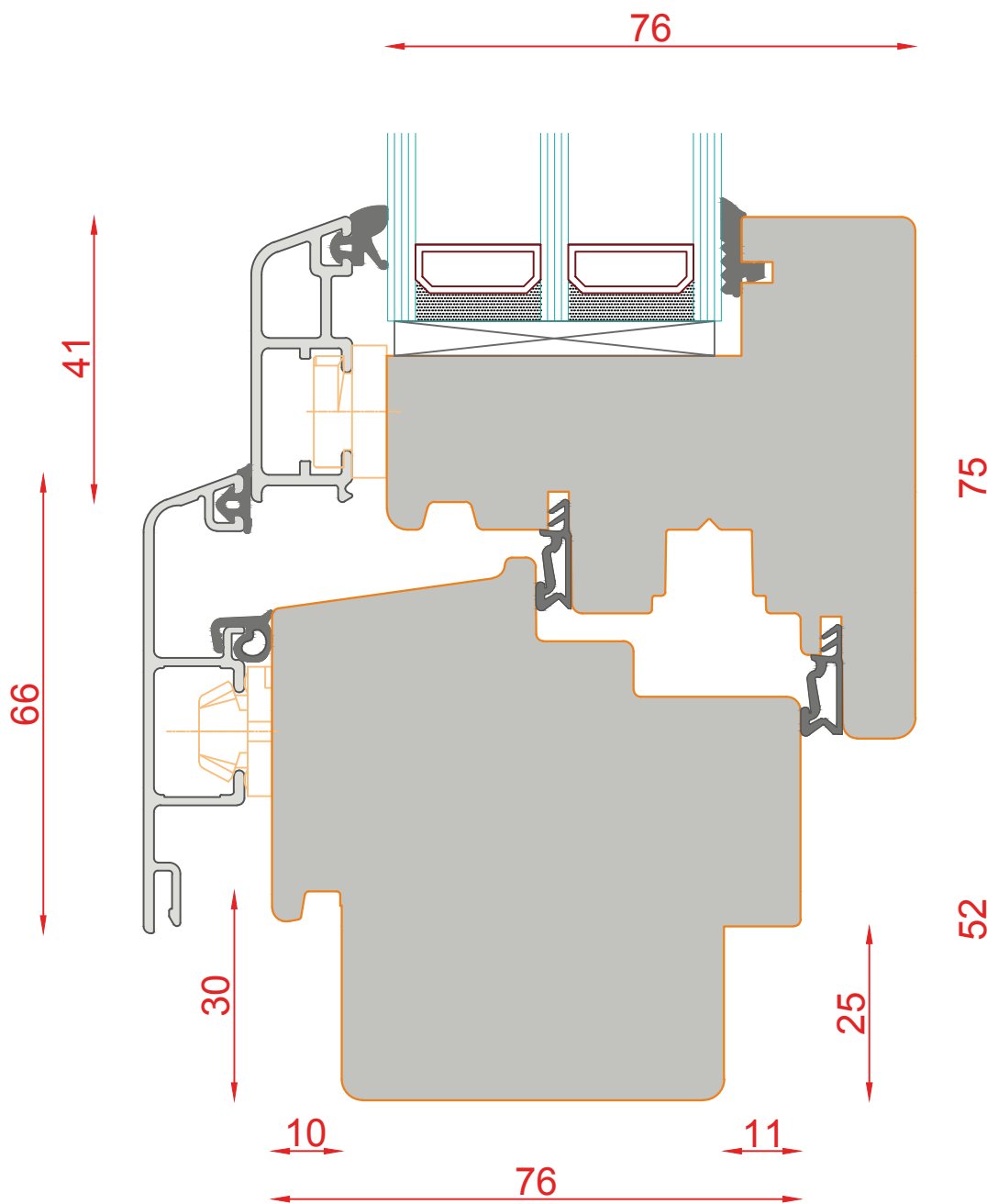
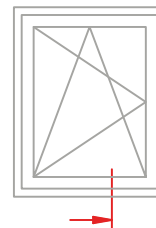

DUO 96
MIT MIRA-SCHALEN

Schnitt : Vertikal Unten

Typ: DK mit Fensterbankfalz | Seite: 136

SCHMIDT VISBEK
Fenster Türen Innentüren

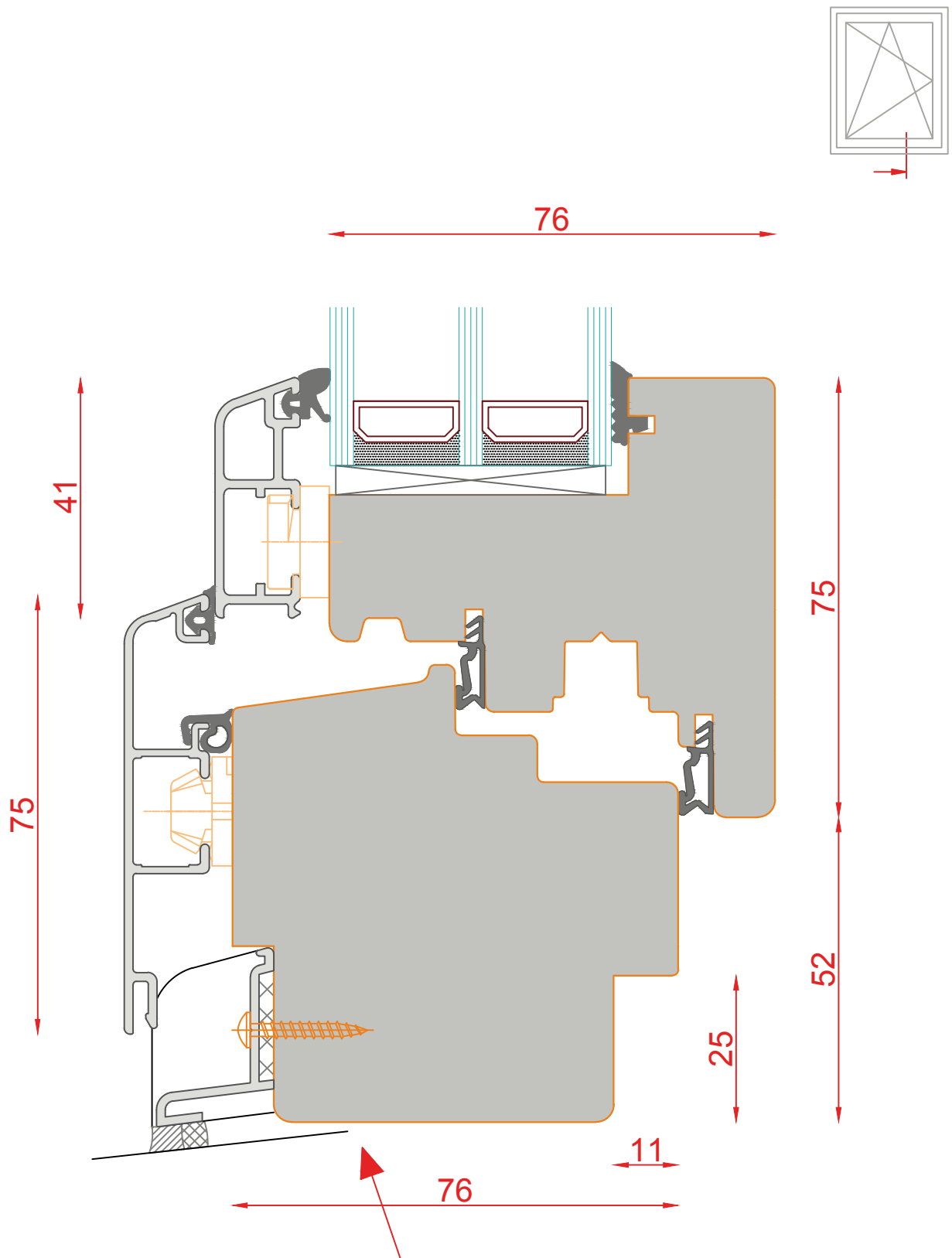

- Befestigung Steinbankanschluss optional:**
- Sichtbar mit Schraube
 - oder angeklebt
 - mit Endkappen



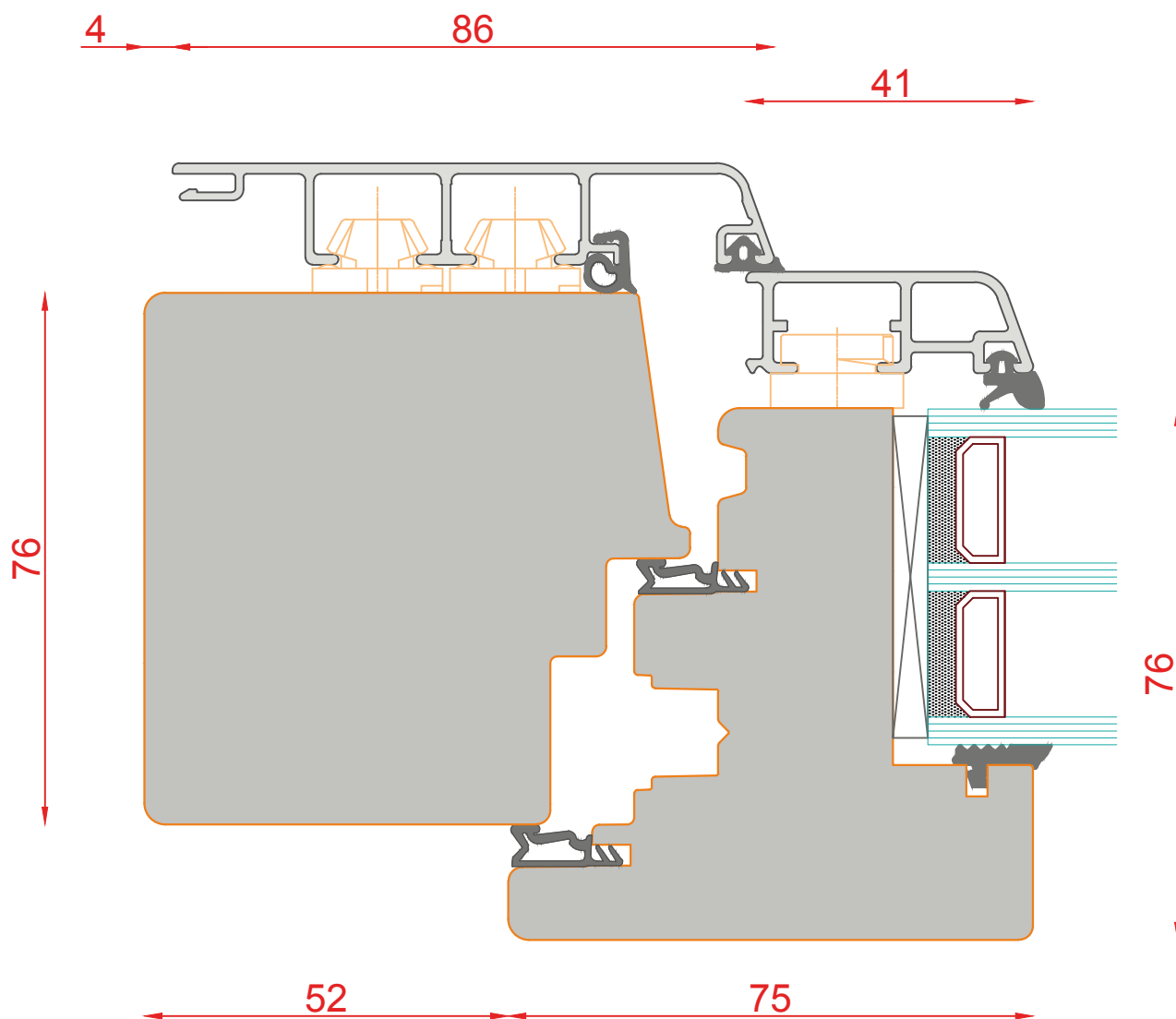
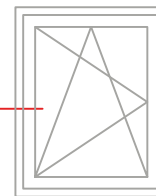

DUO 96
MIT MIRA-SCHALEN

Schnitt : Horizontal seitlich und oben

Typ: DK

| Seite: 138

SCHMIDT VISBEK
Fenster Türen Innenelemente

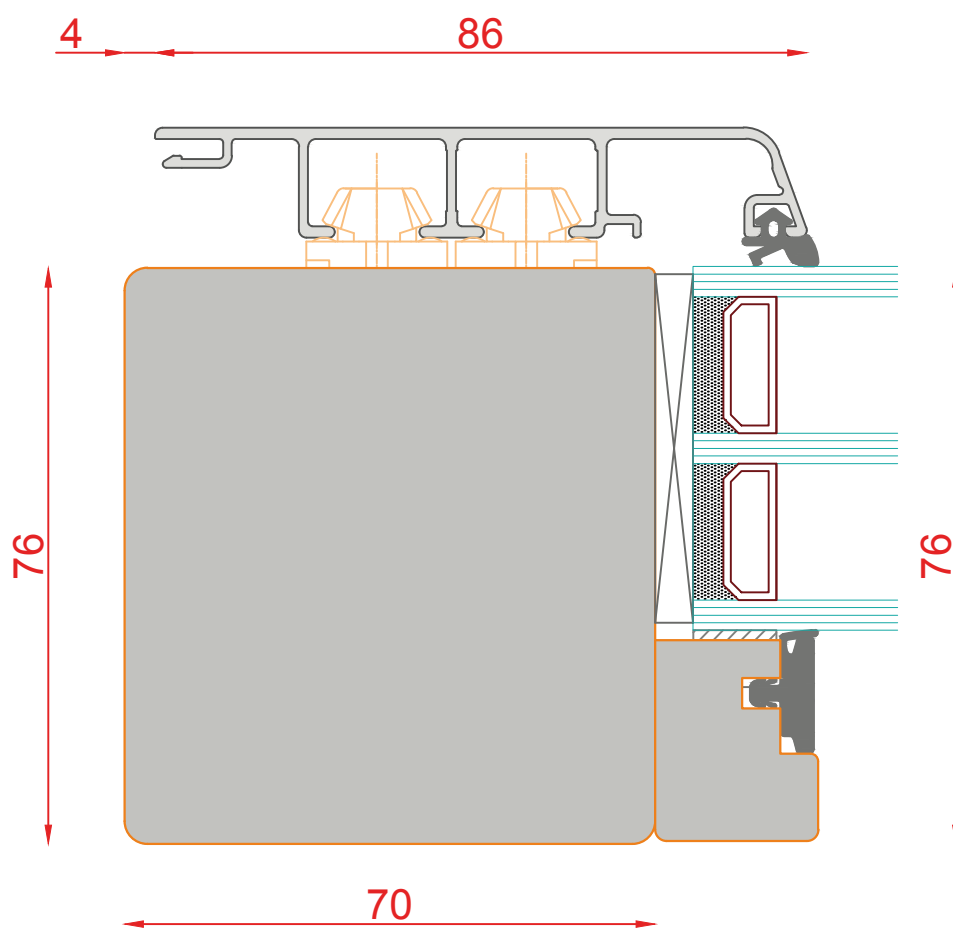
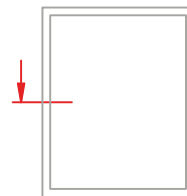

DUO 96
MIT MIRA-SCHALEN

Schnitt : Horizontal seitlich und oben

Typ: FiB

| Seite: 139

SCHMIDT VISBEK
Fenster Türen Innenelemente

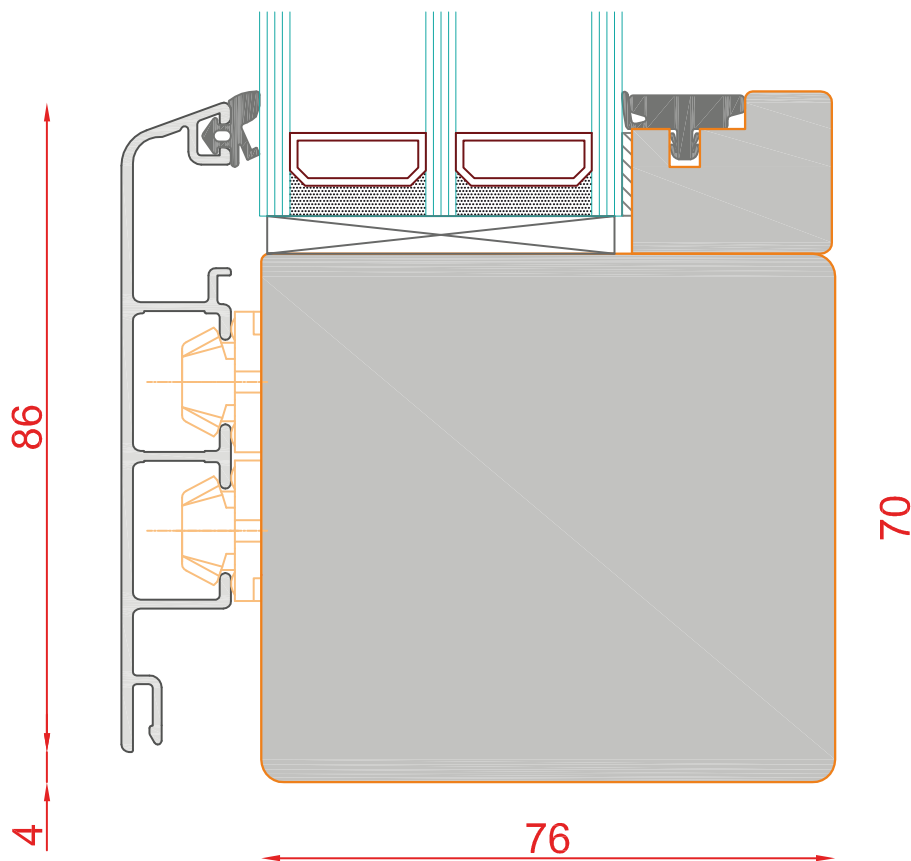
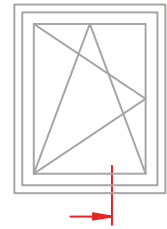

DUO 96
MIT MIRA-SCHALEN

Schnitt : Vertikal unten

Typ: FIB

| Seite: 140

SCHMIDT VISBEK
Fenster. Türen. Innovationen.

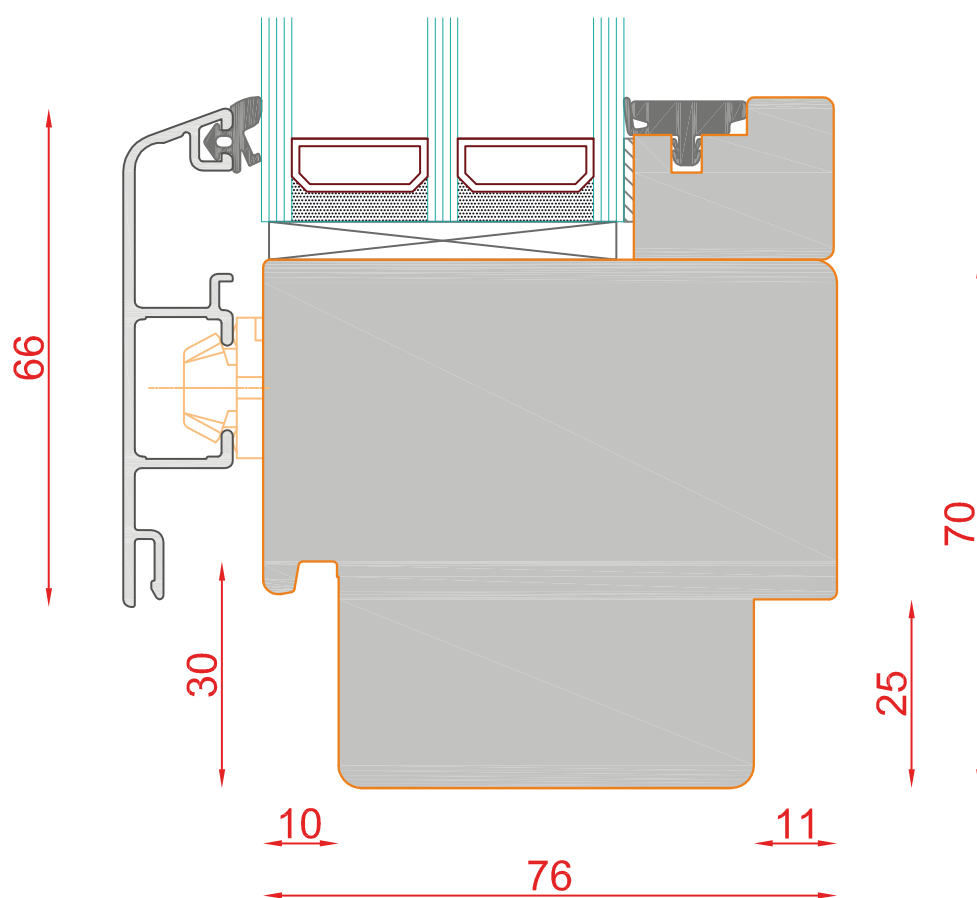
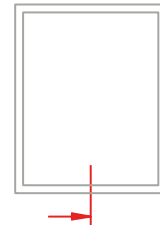

DUO 96
MIT MIRA-SCHALEN

Schnitt : Vertikal unten

Fensterbankanschluss

| Seite: 141

SCHMIDT VISBEK
Fenster. Türen. Innovationen.

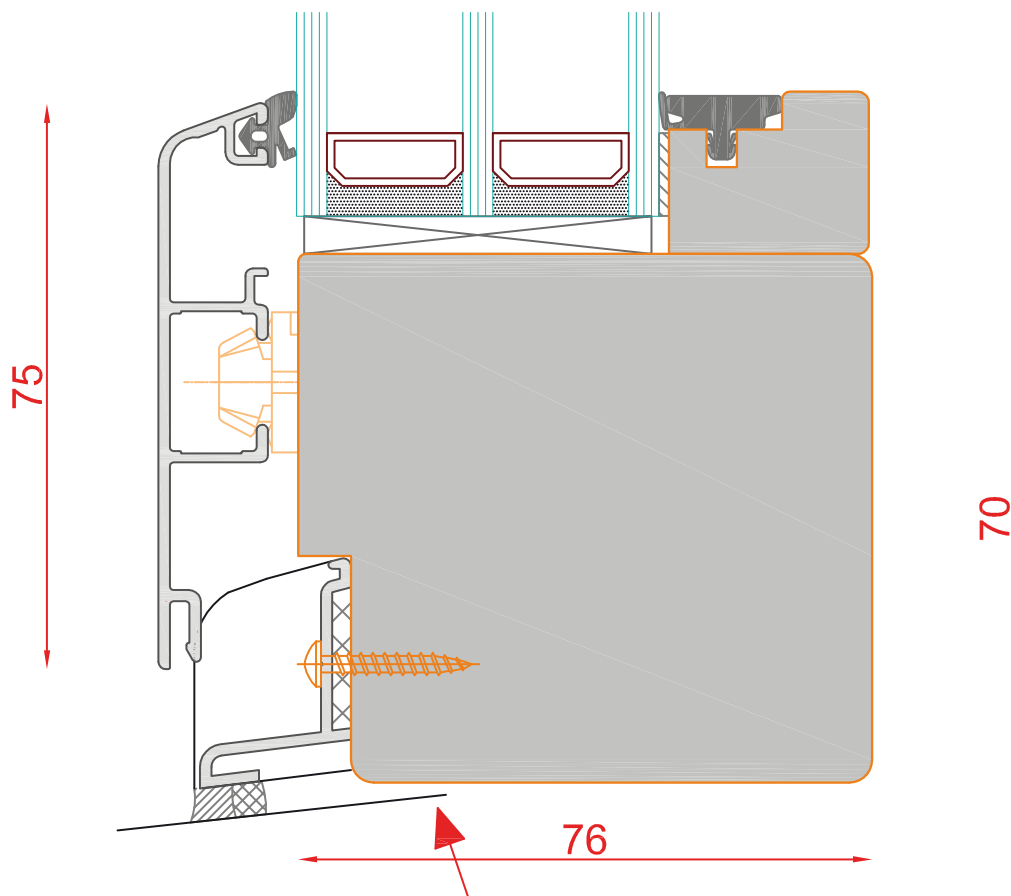
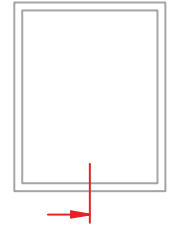

Befestigung Steinbankanschluss optional:

- sichtbar mit Schraube
- oder angeklebt
- mit Endkappen



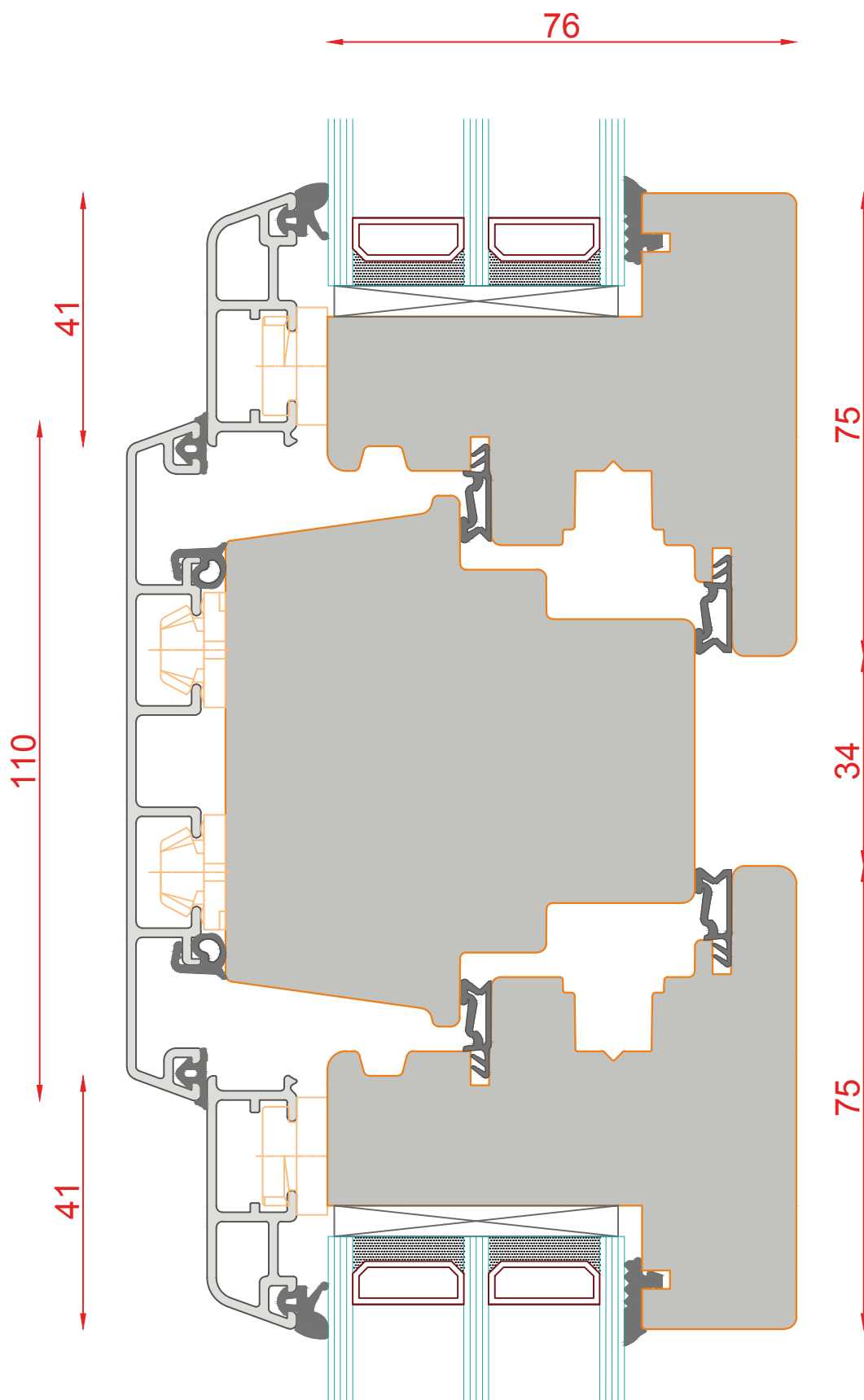
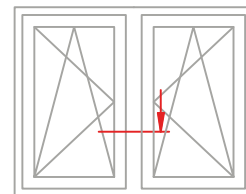

DUO 96
MIT MIRA-SCHALEN

Schnitt : Horizontal Mitte Pfosten

Typ: DK mit Mittelpfosten

| Seite: 143

SCHMIDT VISBEK
Fenster Türen Innenelemente



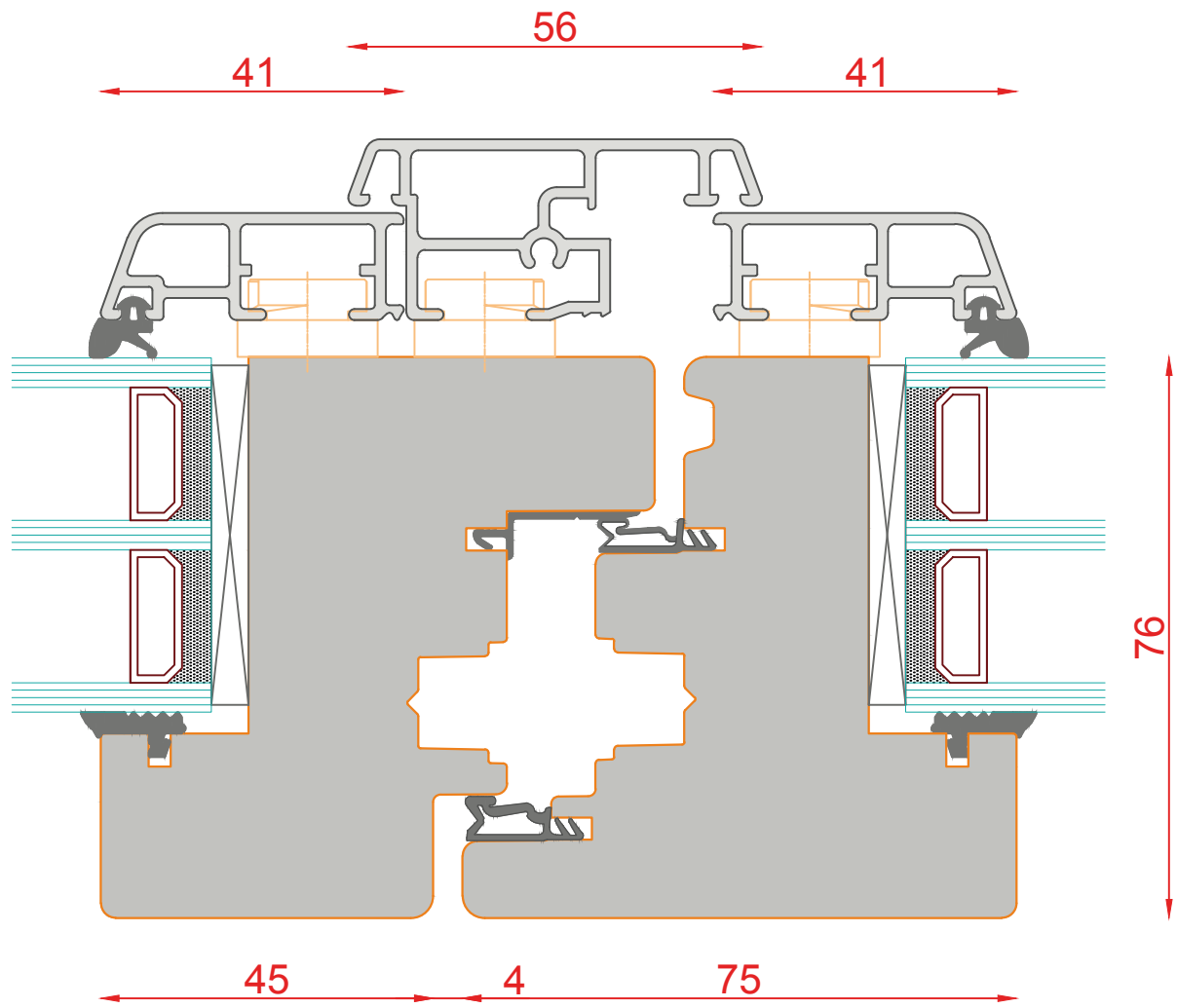
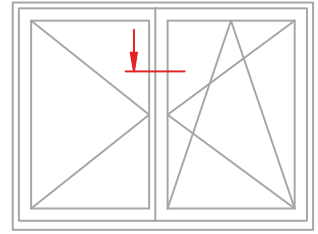

DUO 96
MIT MIRA-SCHALEN

Schnitt : Horizontal Stulp

Typ: DK

| Seite: 144

SCHMIDT VISBEK

Fenster Türen Innenelemente

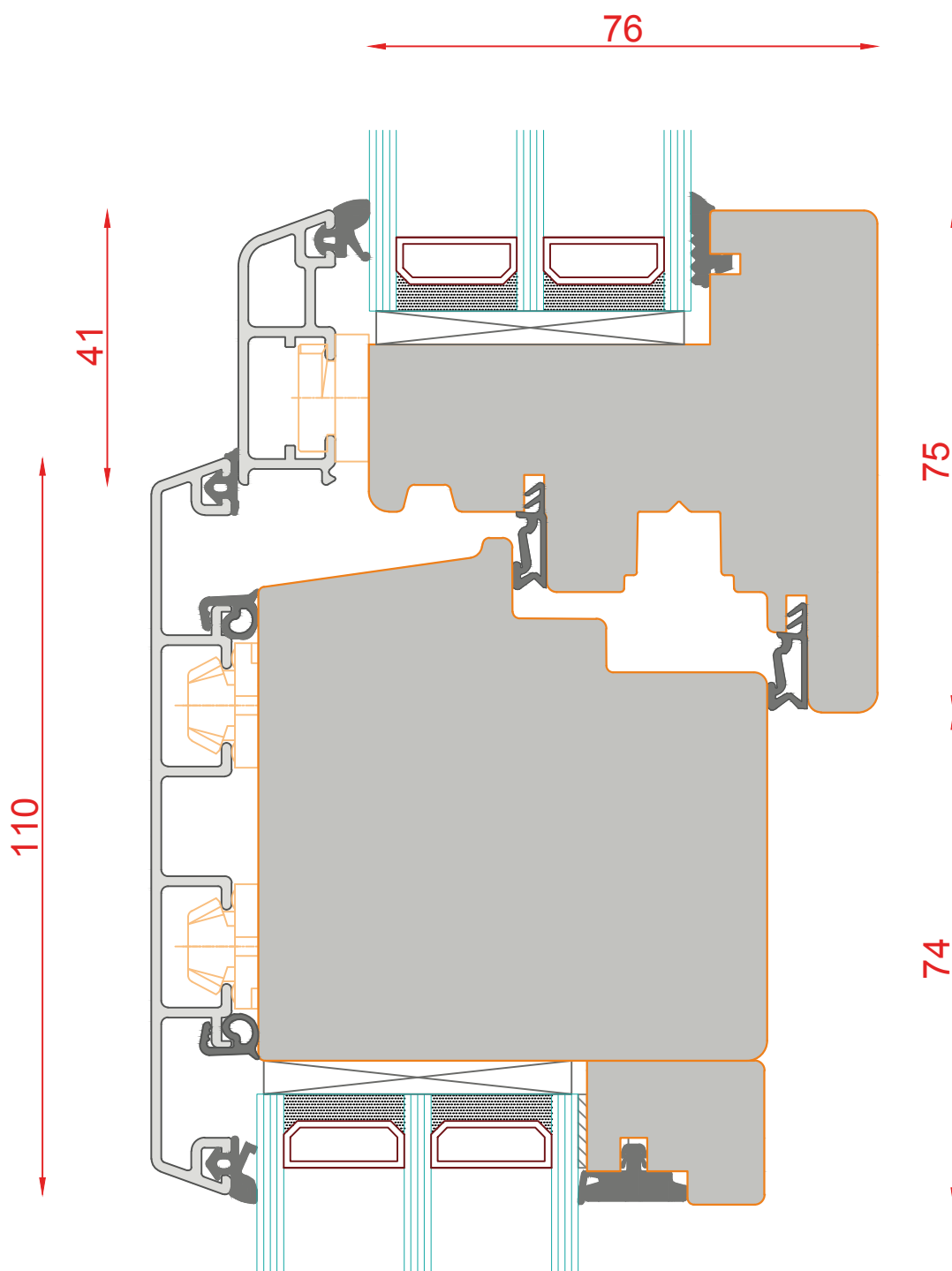
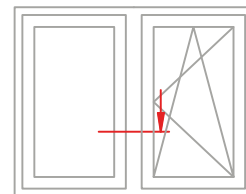

DUO 96
MIT MIRA-SCHALEN

Schnitt : Horizontal Mitte

Typ: DK - FIB

| Seite: 145

SCHMIDT VISBEK
Fenster · Türen · Innenelemente

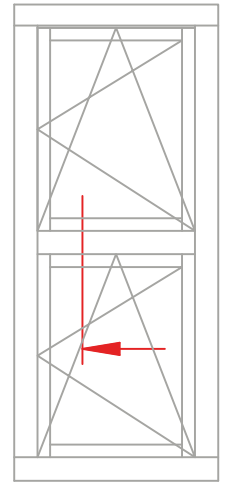
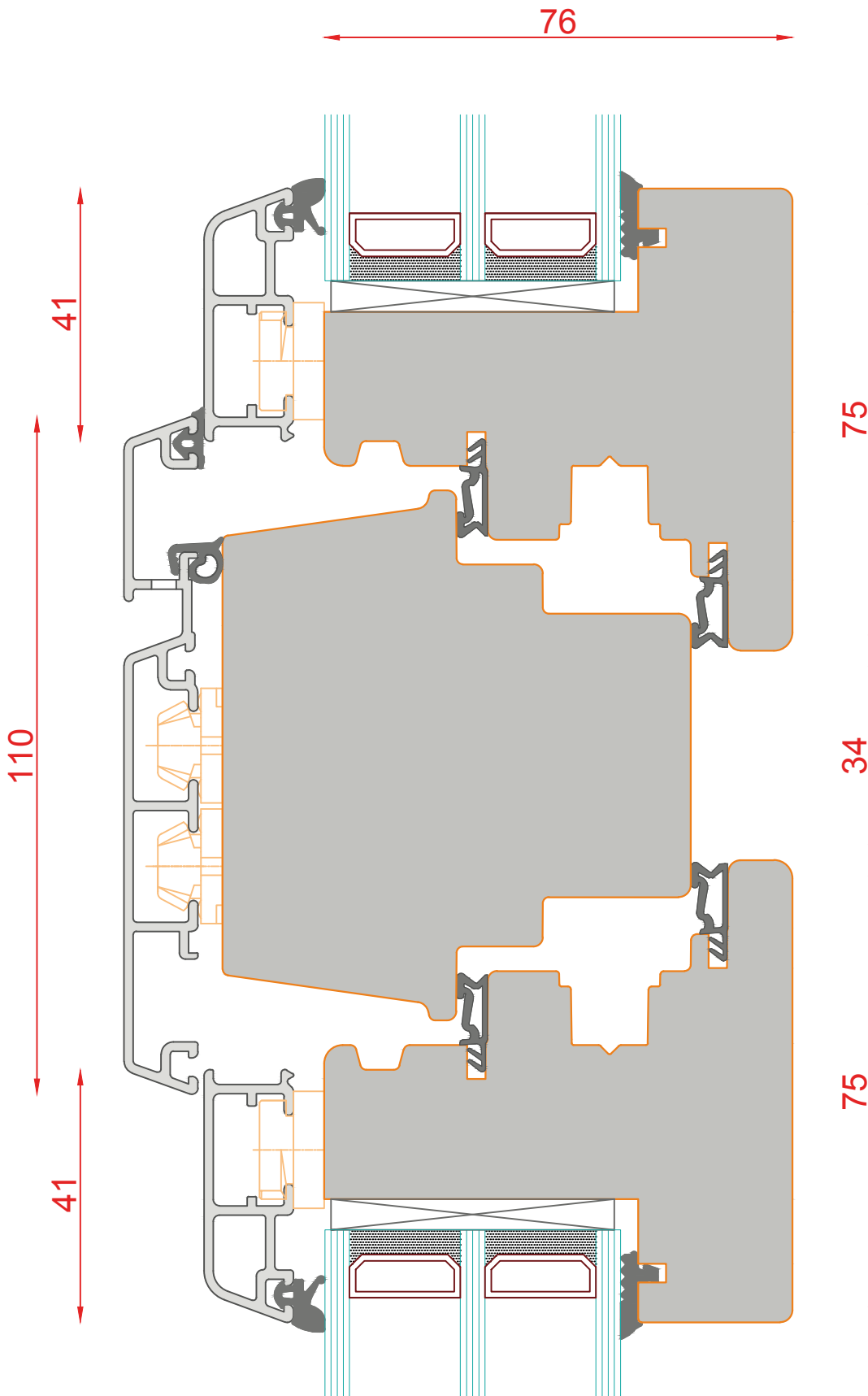

DUO 96
MIT MIRA-SCHALEN

Schnitt : Vertikal

Typ: Kämpfer DK - DK

| Seite: 146

SCHMIDT VISBEK

Fenster Türen Innenelemente



110

41

76

75

74

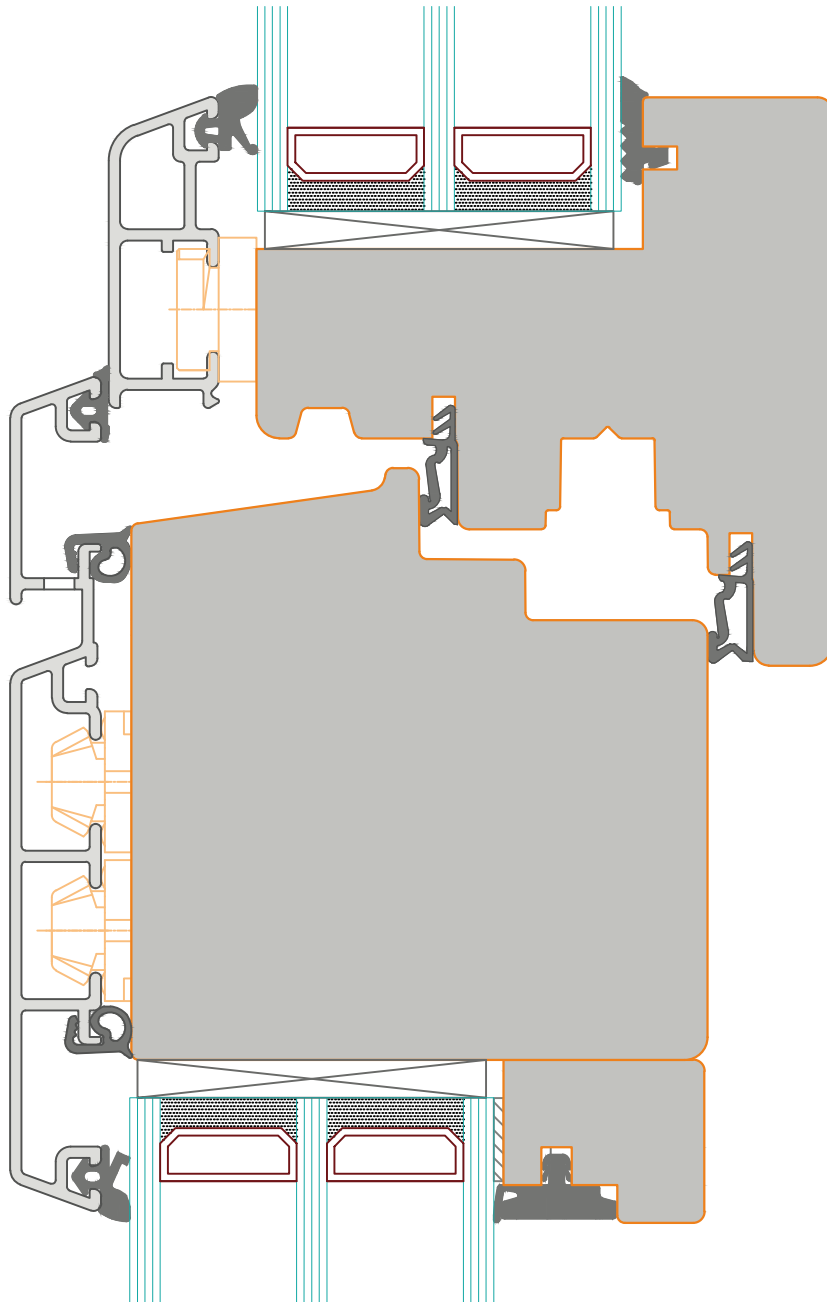
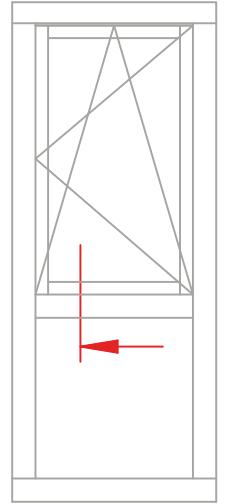

DUO 96
MIT MIRA-SCHALEN

Schnitt : Vertikal Kämpfer DK-FIB

Typ: FiB

| Seite: 147

SCHMIDT VISBEK
Fenster Türen Innenelemente

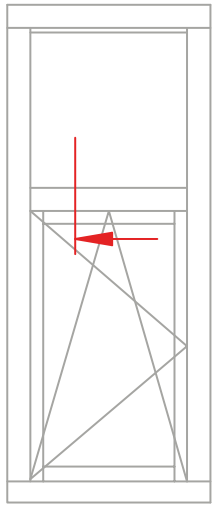
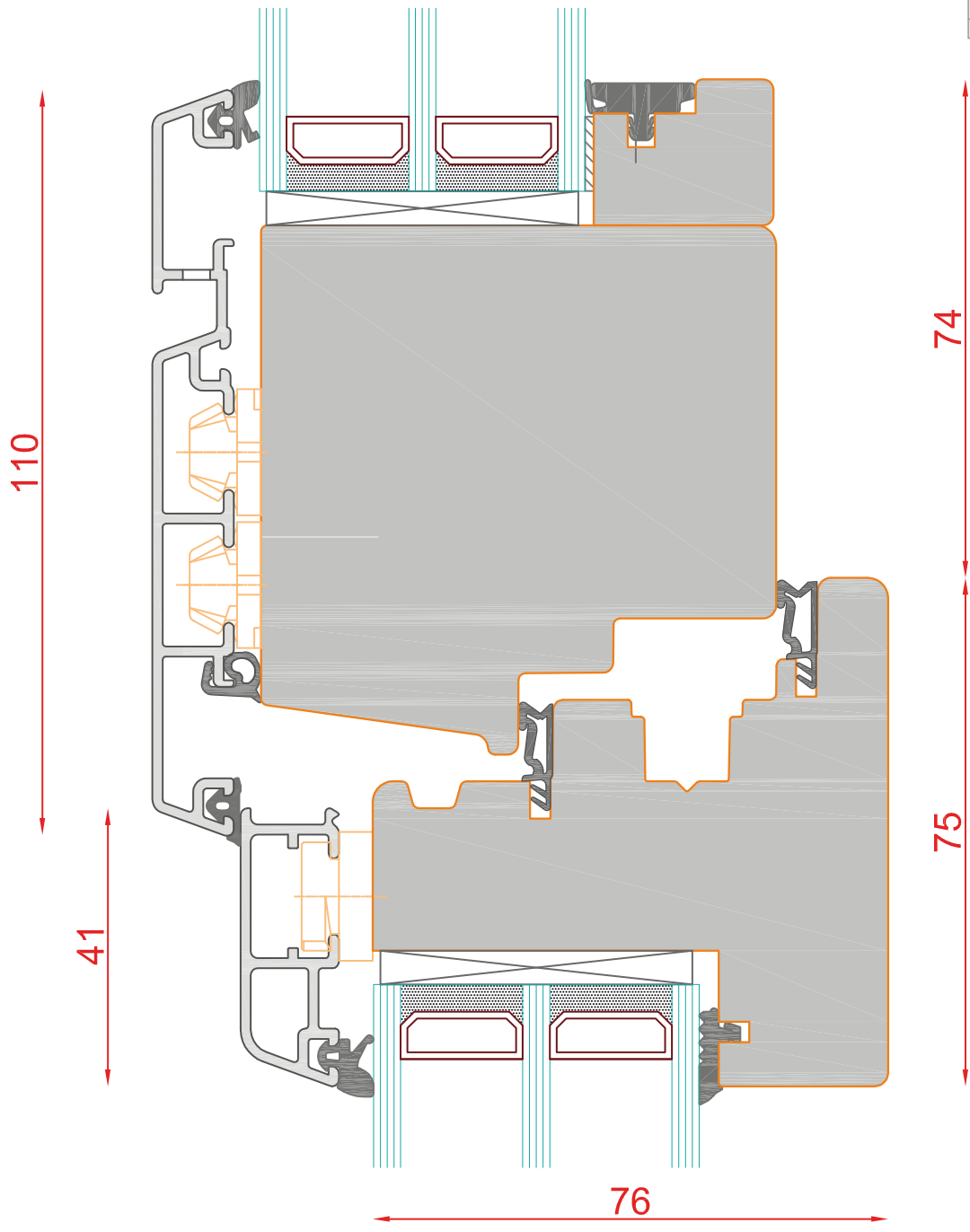

DUO 96
MIT MIRA-SCHALEN

Schnitt : Vertikal Kämpfer DK-FIB

Typ: FiB

| Seite: 148

SCHMIDT VISBEK
Fenster. Türen. Innovationen.

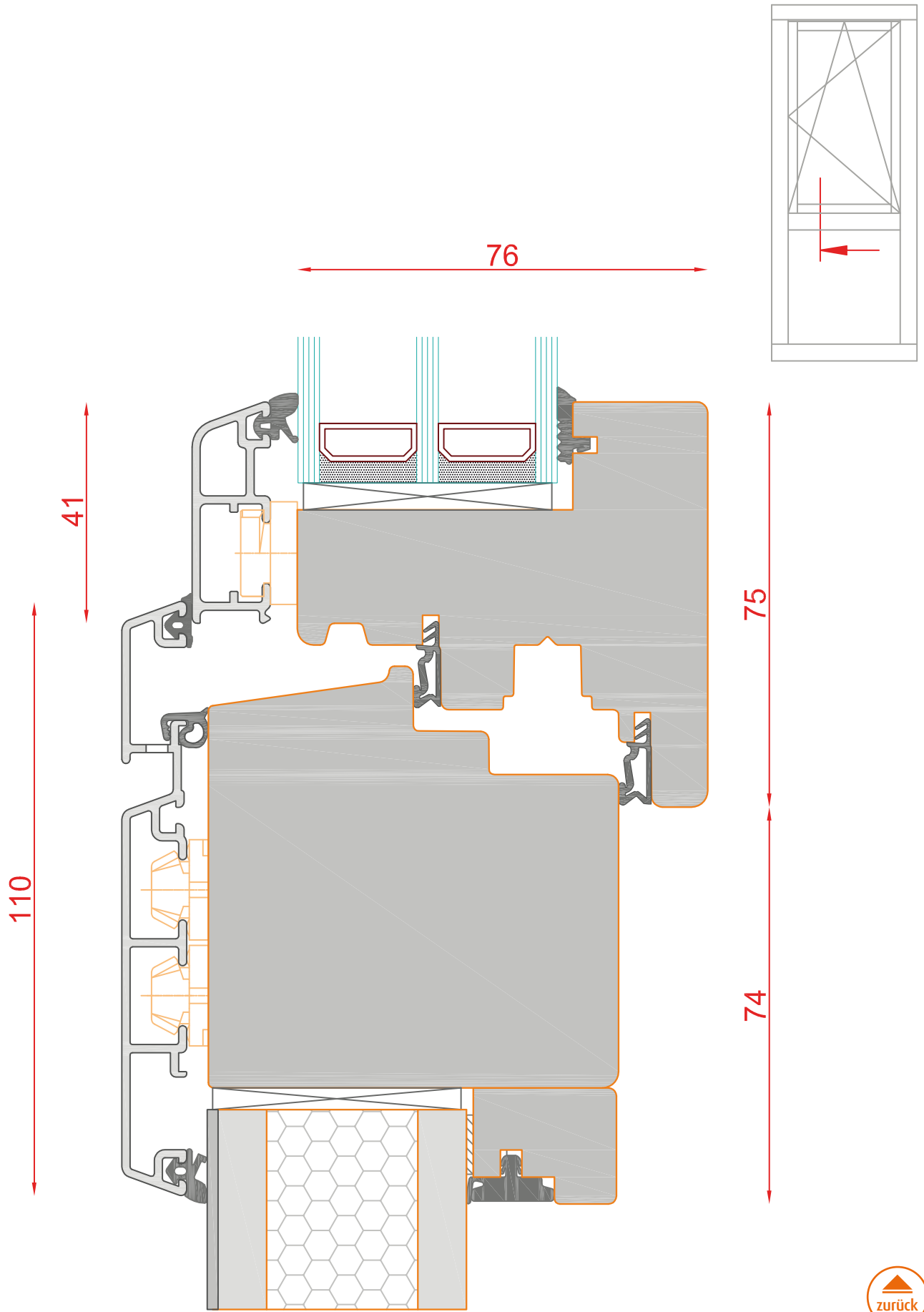

DUO 96
MIT MIRA-SCHALEN

Schnitt : Vertikal Kämpfer DK-FIB

Typ: Füllung

| Seite: 149

SCHMIDT VISBEK
Fenster. Türen. Innovationen.

110

41

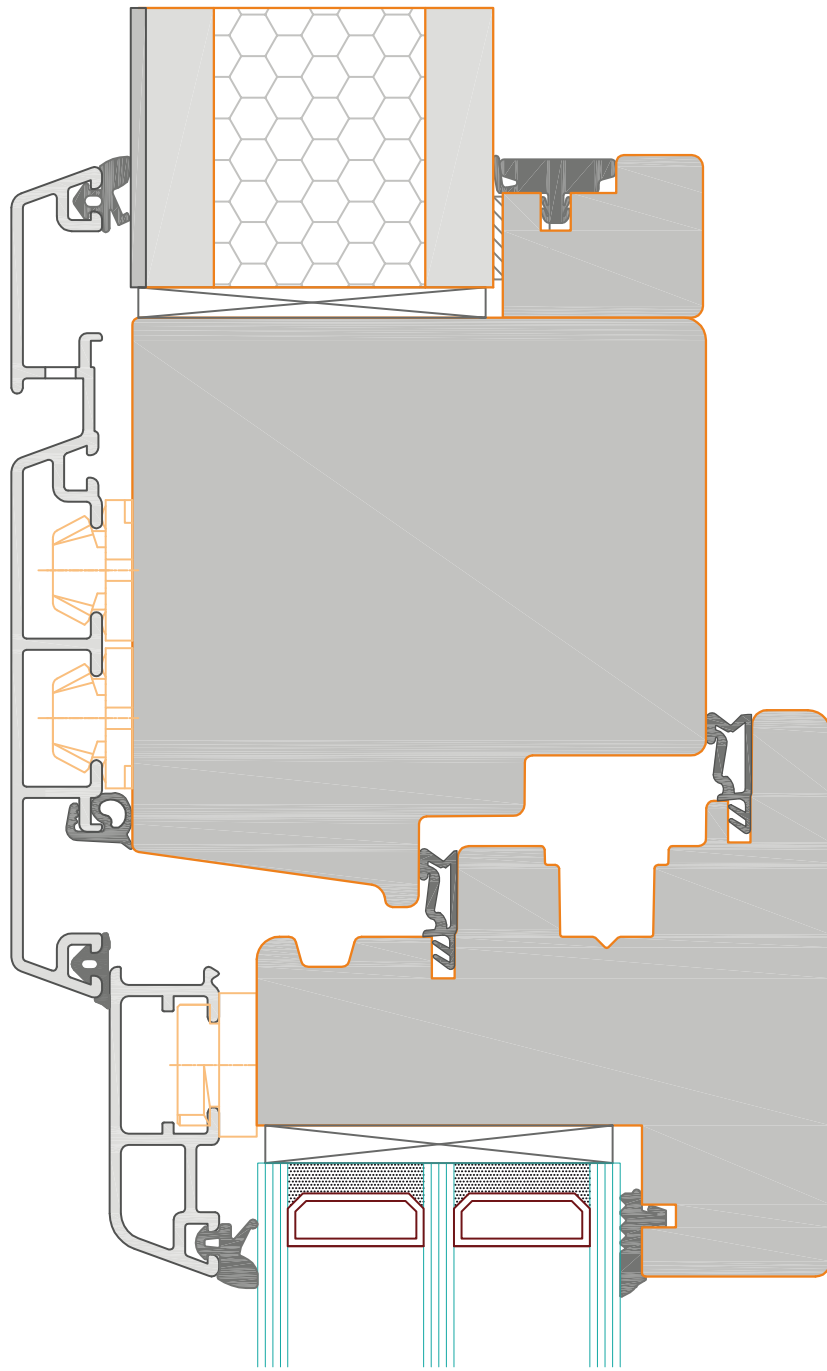

74

75

76



DUO 96
MIT MIRA-SCHALEN

Schnitt : Vertikal Kämpfer DK-FIB

Typ: Füllung

| Seite: 150

SCHMIDT VISBEK
Fenster. Türen. Innovationen.

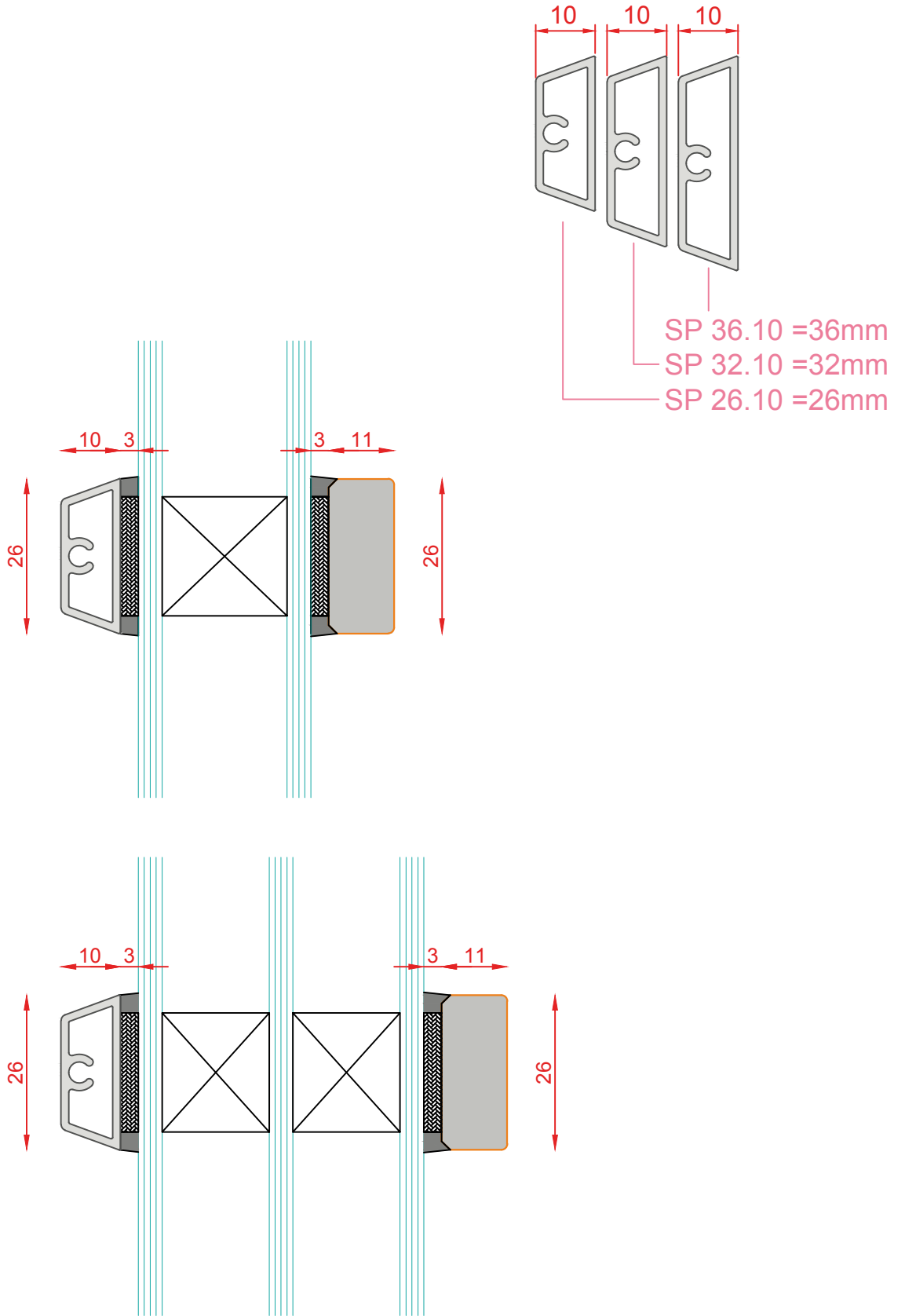

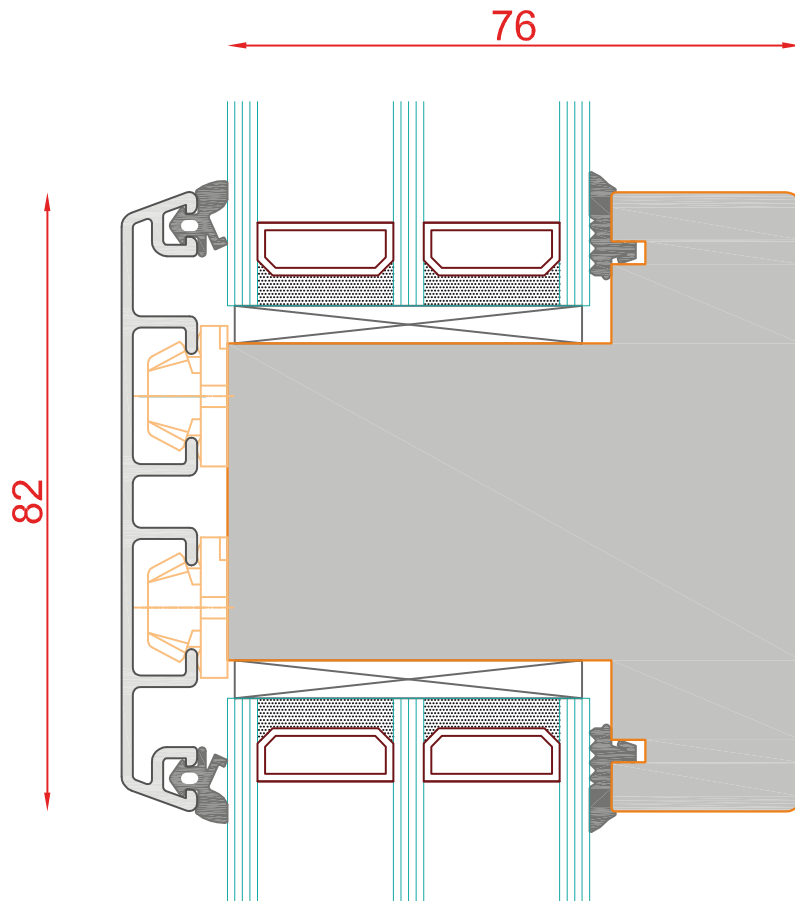
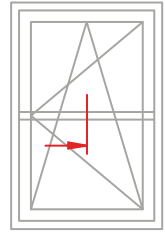

DUO 96
MIT MIRA-SCHALEN

Schnitt : Sprosse Glasteilend

Typ: Flügel

| Seite: 152

SCHMIDT VISBEK
Fenster. Türen. Innovationen.

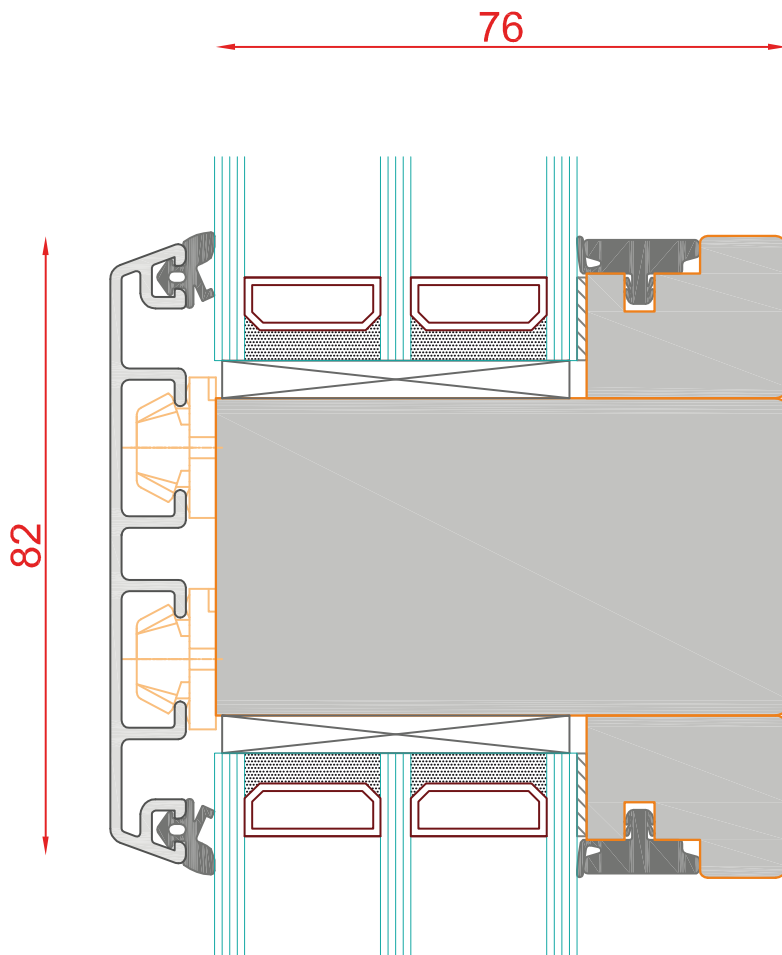
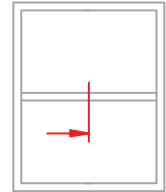

DUO 96
MIT MIRA-SCHALEN

Schnitt : Sprosse Glasteilend

Typ: Blendrahmen

| Seite: 153

SCHMIDT VISBEK
Fenster. Türen. Innovationen.

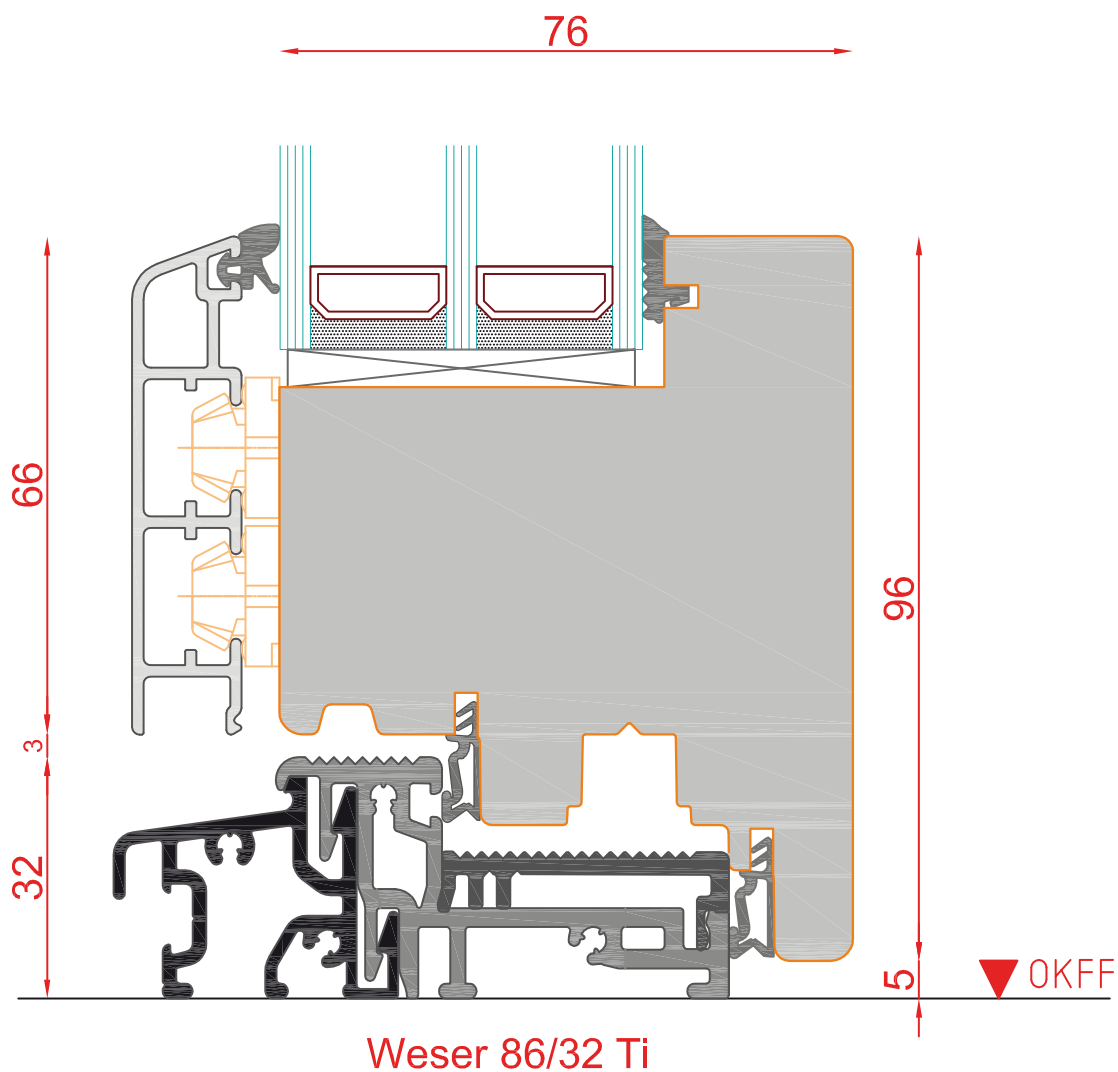
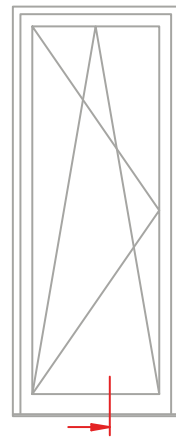

DUO 96
MIT MIRA-SCHALEN

Schnitt : Vertikal unten

Weser Schiene 20mm

| Seite: 154

SCHMIDT VISBEK
Fenster. Türen. Innovationen.

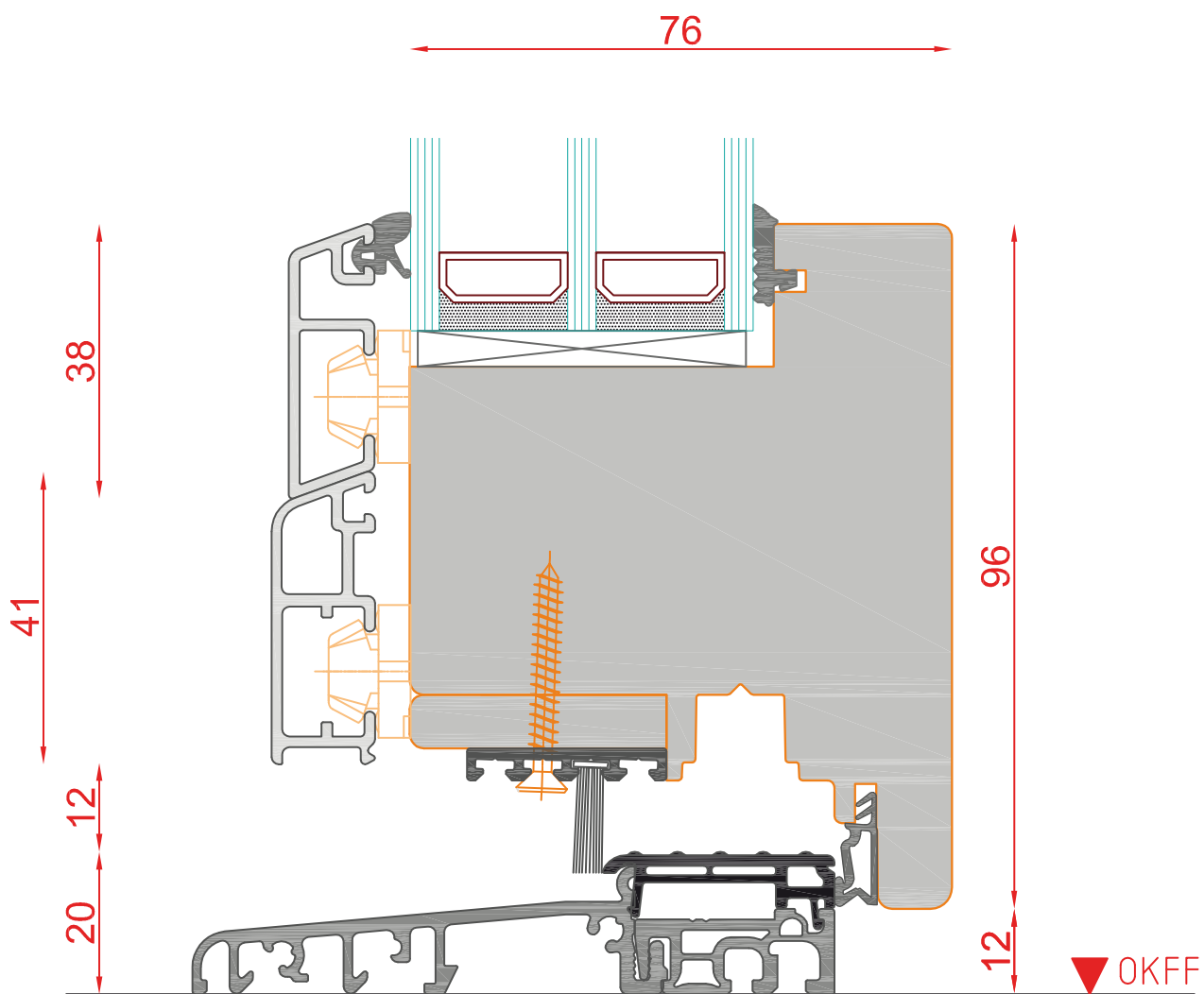
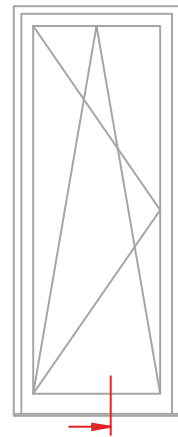

Bodenschwelle BKV Eifel 90 TB



DUO 96
MIT MIRA-SCHALEN

Schnitt : Vertikal unten

Eifel Schiene 20mm

| Seite: 155

SCHMIDT VISBEK
Fenster. Türen. Innovationen.

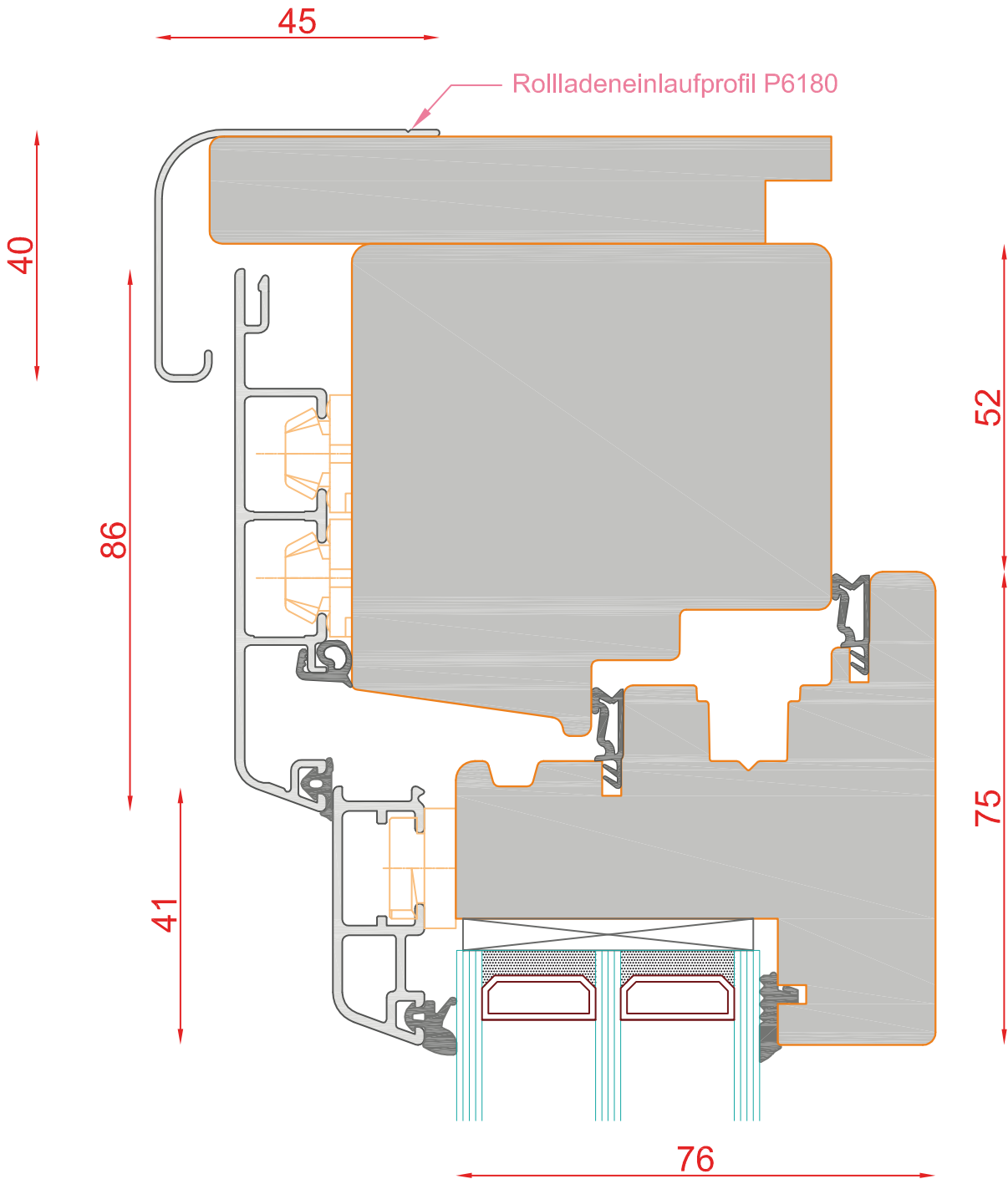
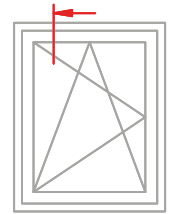

DUO 96
MIT MIRA-SCHALEN

Schnitt : Horizontal seitlich und oben

Typ: DK

| Seite: 156

SCHMIDT VISBEK
Fenster. Türen. Innovationen.

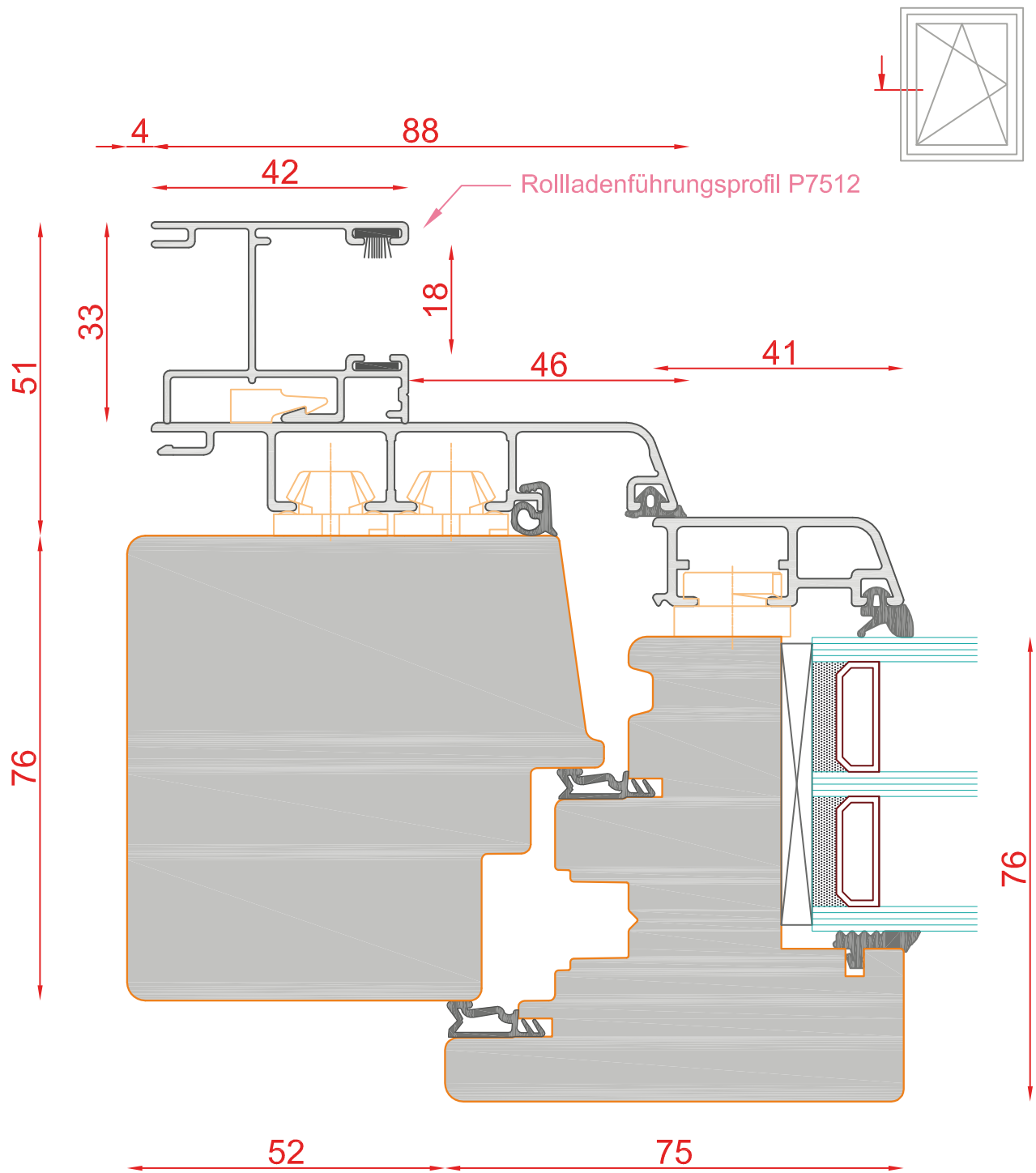

DUO 96
MIT MIRA-SCHALEN

Schnitt : Horizontal seitlich und oben

Typ: DK

| Seite: 157

SCHMIDT VISBEK
Fenster. Türen. Innovationen.

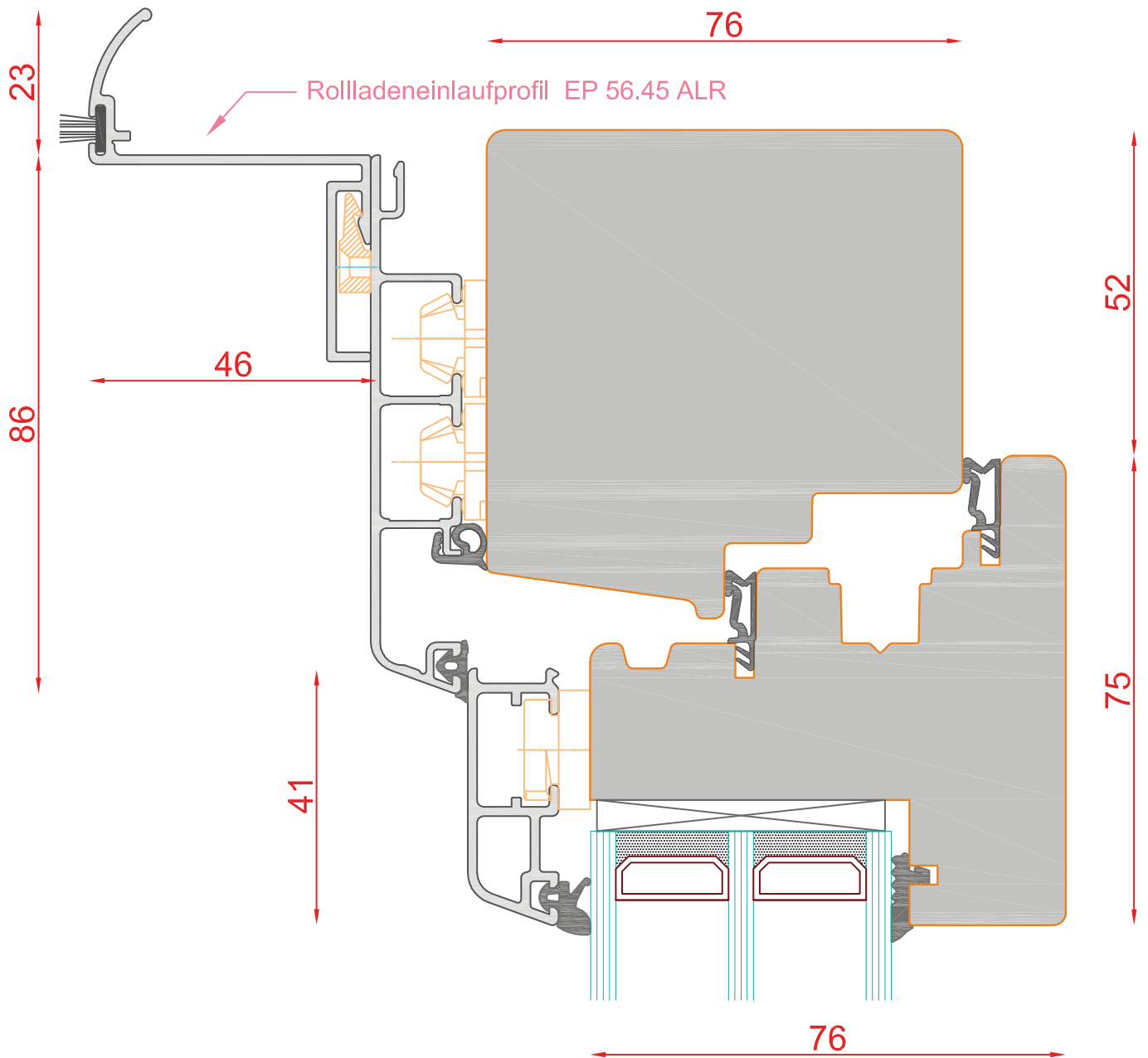
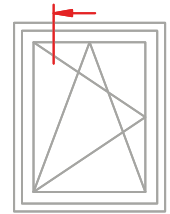

DUO 96
MIT MIRA-SCHALEN

Schnitt : Horizontal seitlich und oben

Typ: DK

| Seite: 158



SCHMIDT VISBEK
Fenster. Türen. Innovationen.

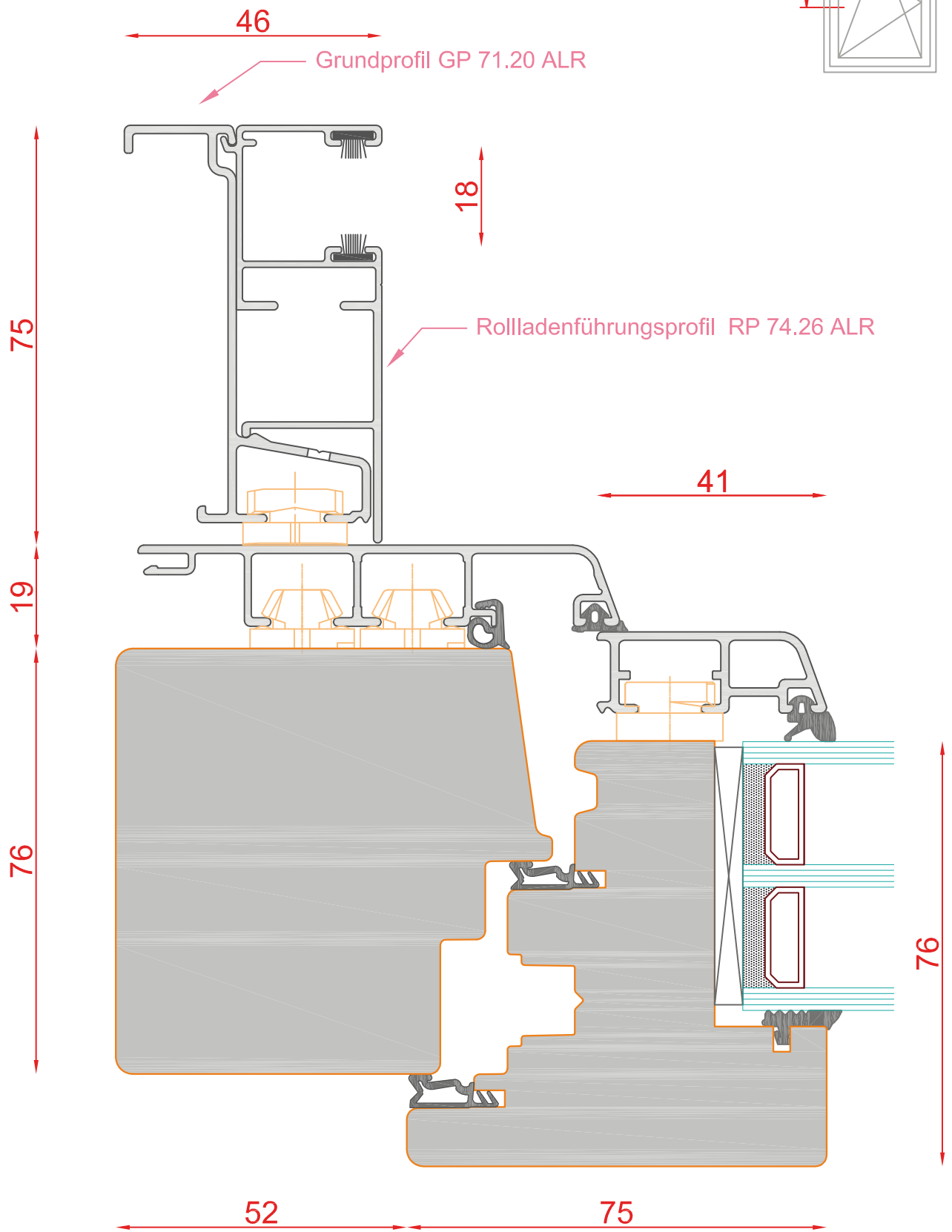

DUO 96
MIT MIRA-SCHALEN

Schnitt : Horizontal seitlich und oben

Typ: DK

| Seite: 159

SCHMIDT VISBEK
Fenster. Türen. Innovationen.

DUO 96

mit Mira-Contour-
Schalen

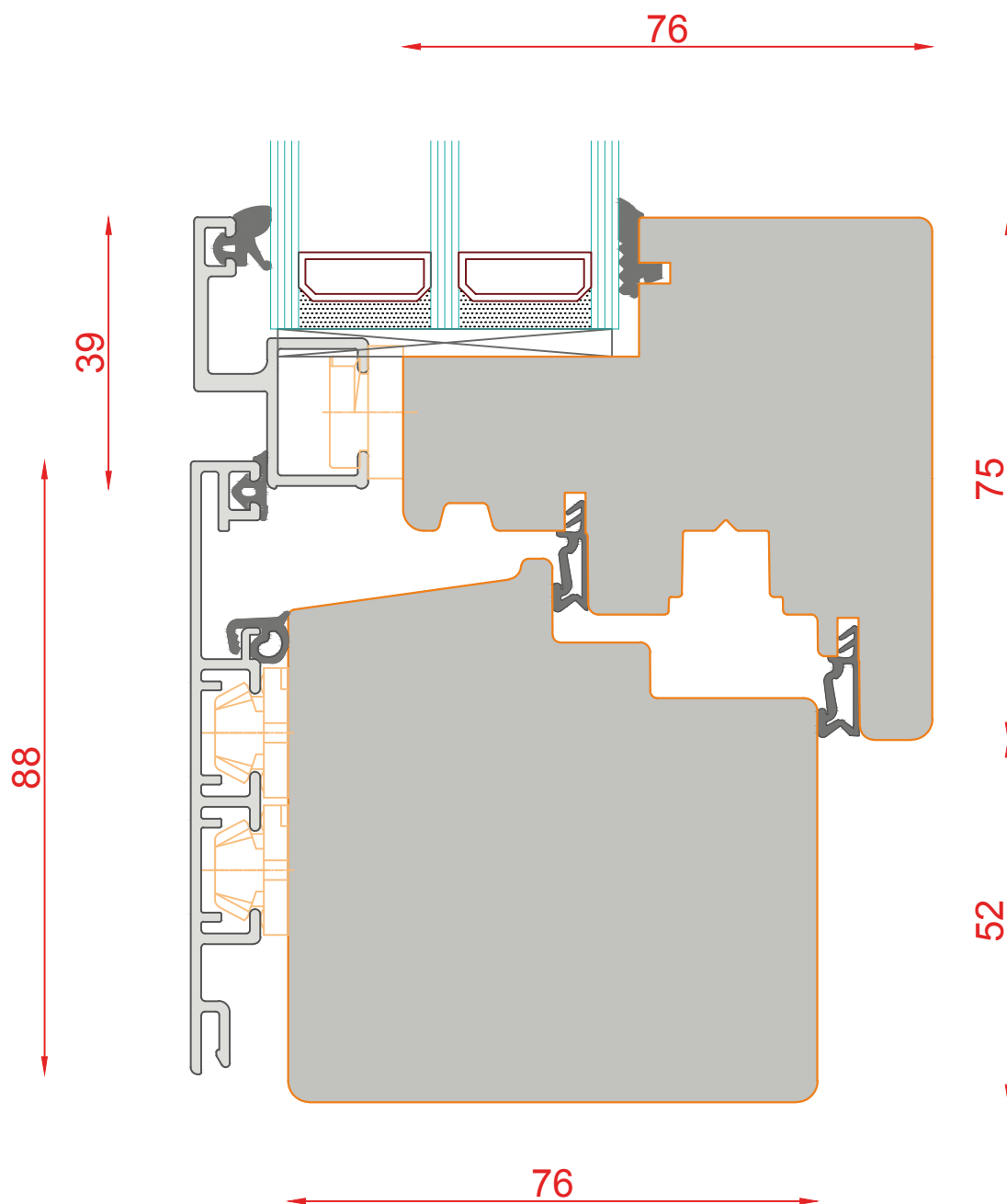
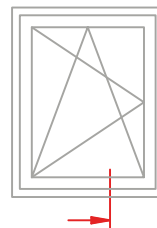

DUO 96
MIT MIRA-CONTOUR-SCHALEN

Schnitt : Vertikal unten

Typ: DK

| Seite: 161

SCHMIDT VISBEK
Fenster Türen Innenelemente

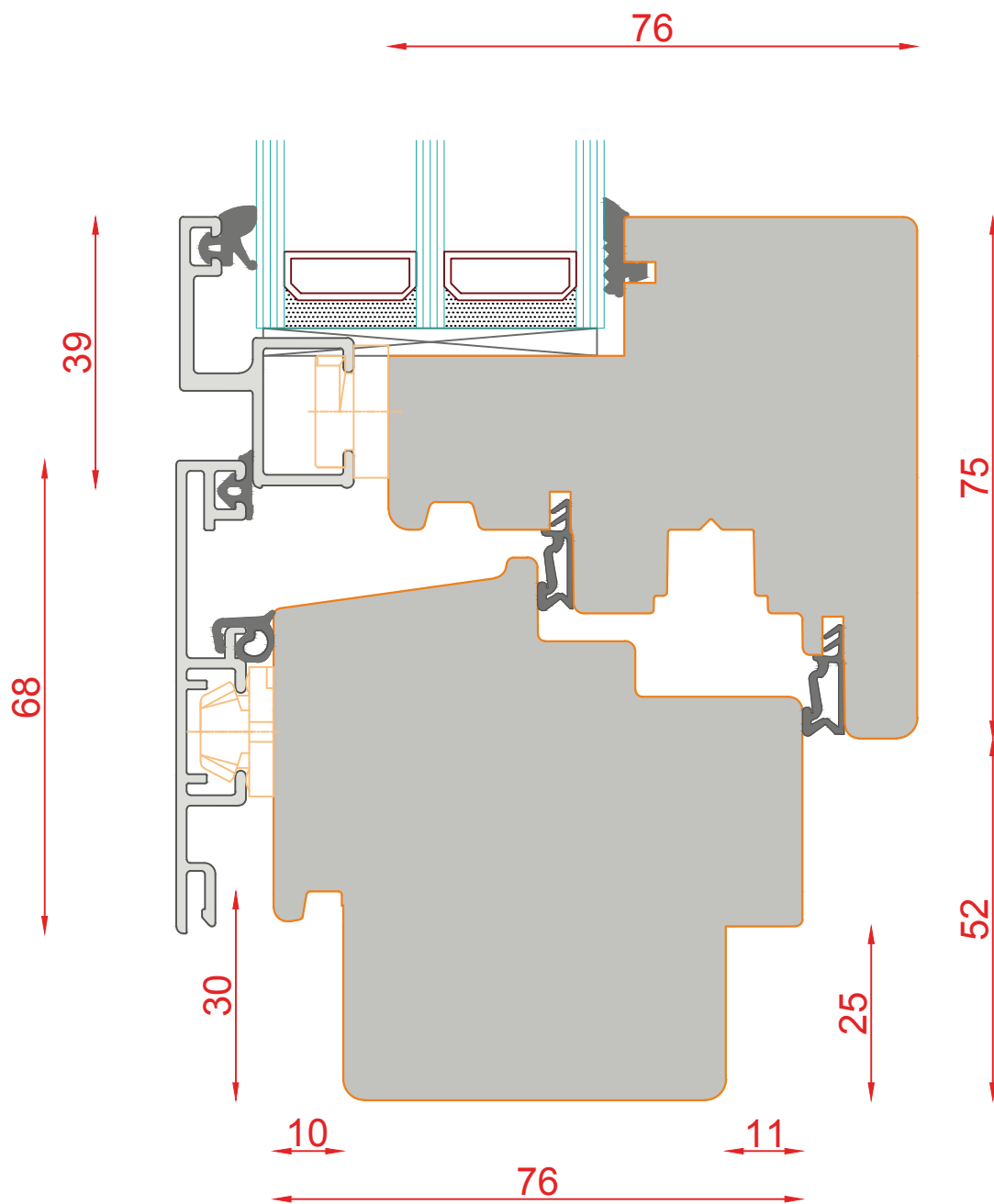
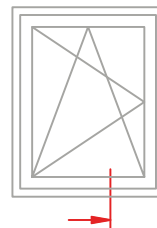

DUO 96
MIT MIRA-SCHALEN

Schnitt : Vertikal Unten

Typ: DK mit Fensterbankfalz | Seite: 162

SCHMIDT VISBEK
Fenster Türen Innentüren

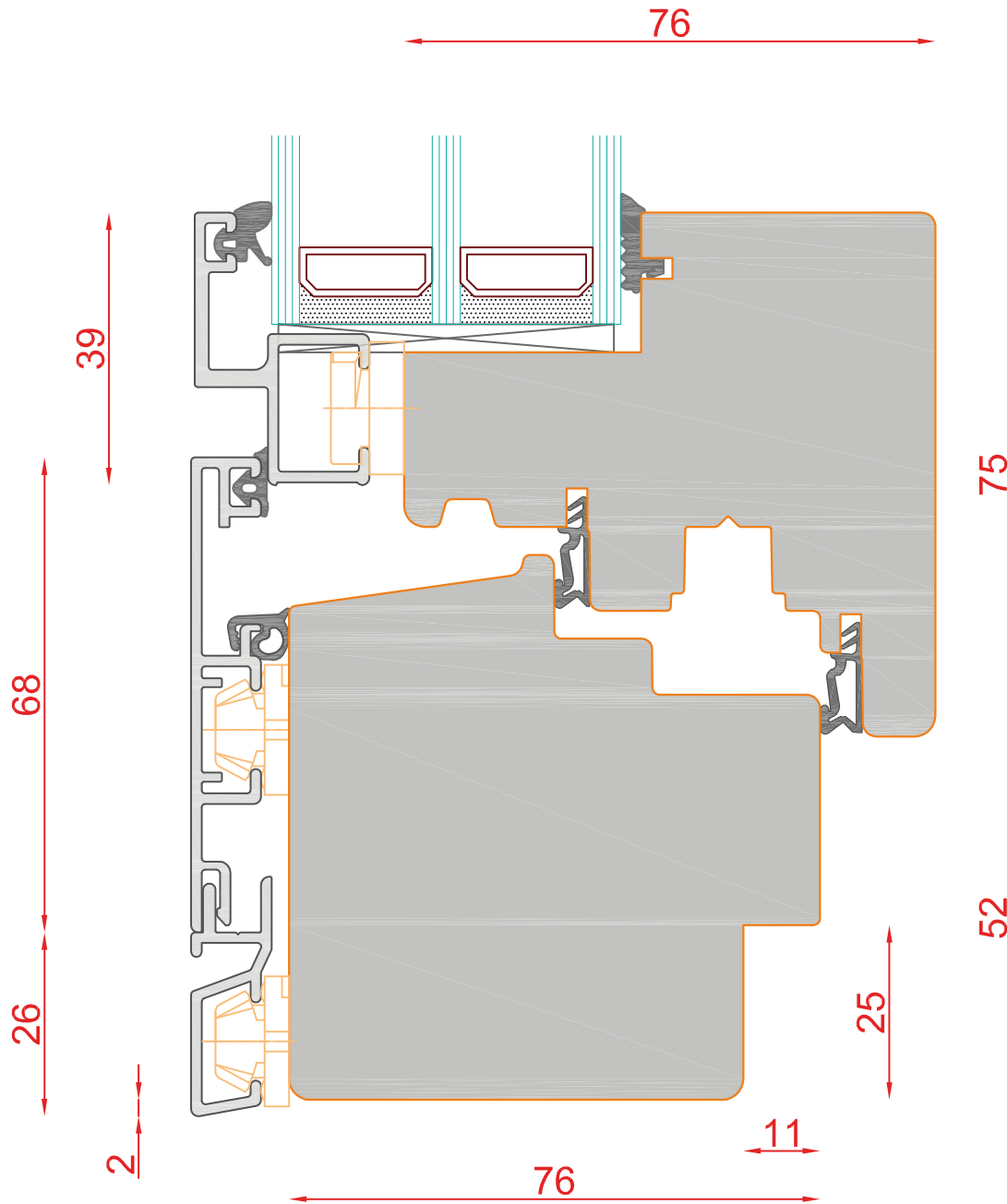
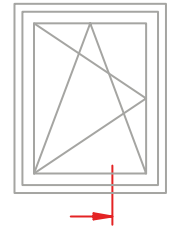

DUO 96
MIT MIRA-SCHALEN

Schnitt : Vertikal Unten

Typ: DK mit Steinbankanschluss | Seite: 163



SCHMIDT VISBEK
Fenster. Türen. Innovationen.

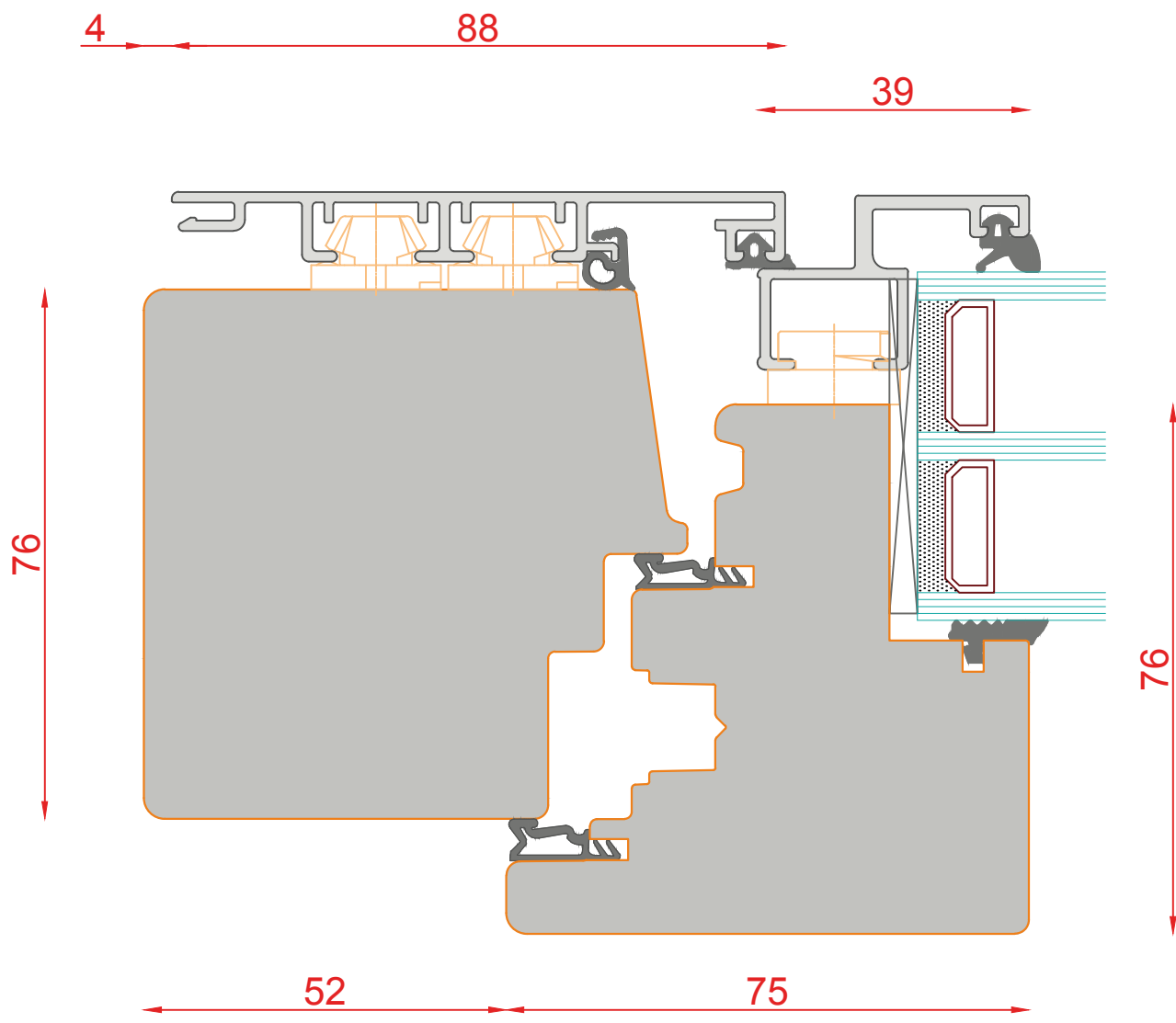
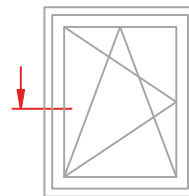

DUO 96
MIT MIRA-SCHALEN

Schnitt : Horizontal seitlich und oben

Typ: DK

| Seite: 164

SCHMIDT VISBEK
Fenster Türen Innenelemente

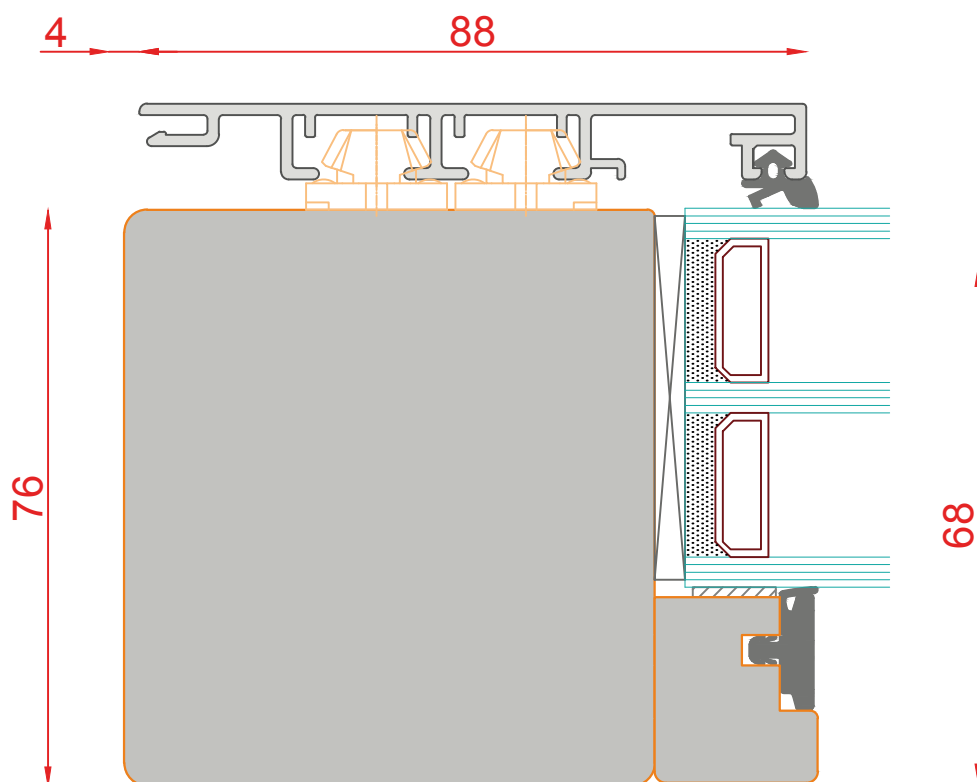
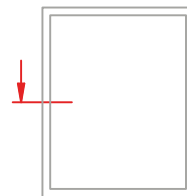

DUO 96
MIT MIRA-SCHALEN

Schnitt : Horizontal seitlich und oben

Typ: FiB

| Seite: 165

SCHMIDT VISBEK
Fenster, Türen, Innenelemente

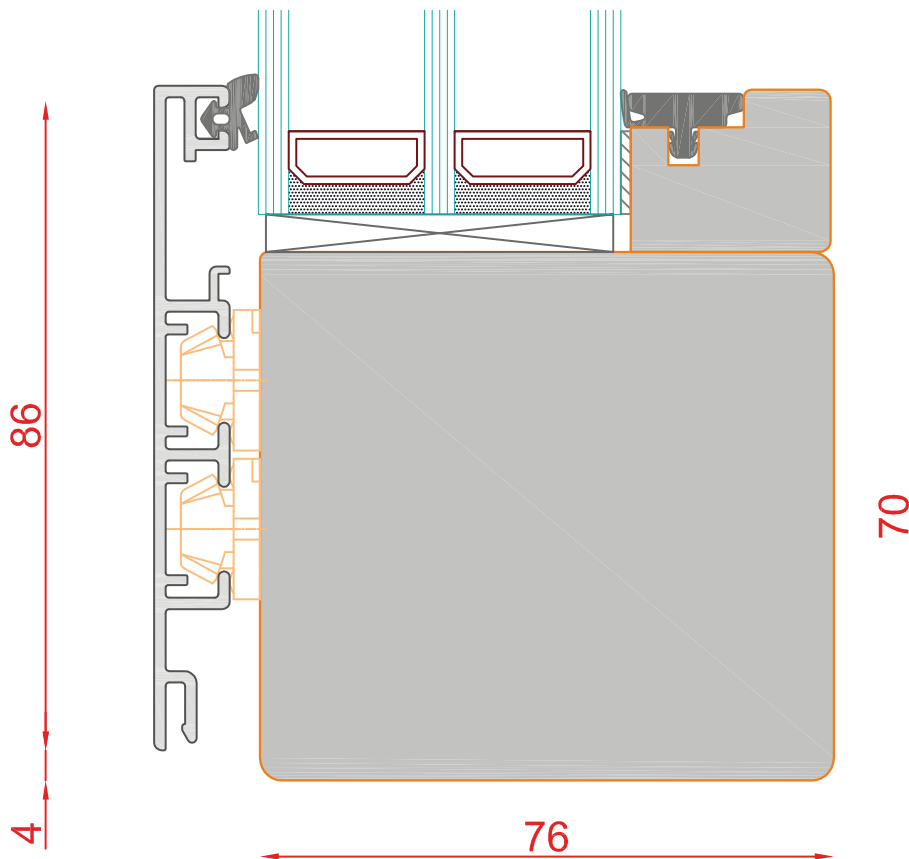
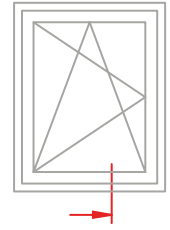

DUO 96
MIT MIRA-SCHALEN

Schnitt : Vertikal unten

Typ: FIB

| Seite: 166

SCHMIDT VISBEK
Fenster. Türen. Innovationen.

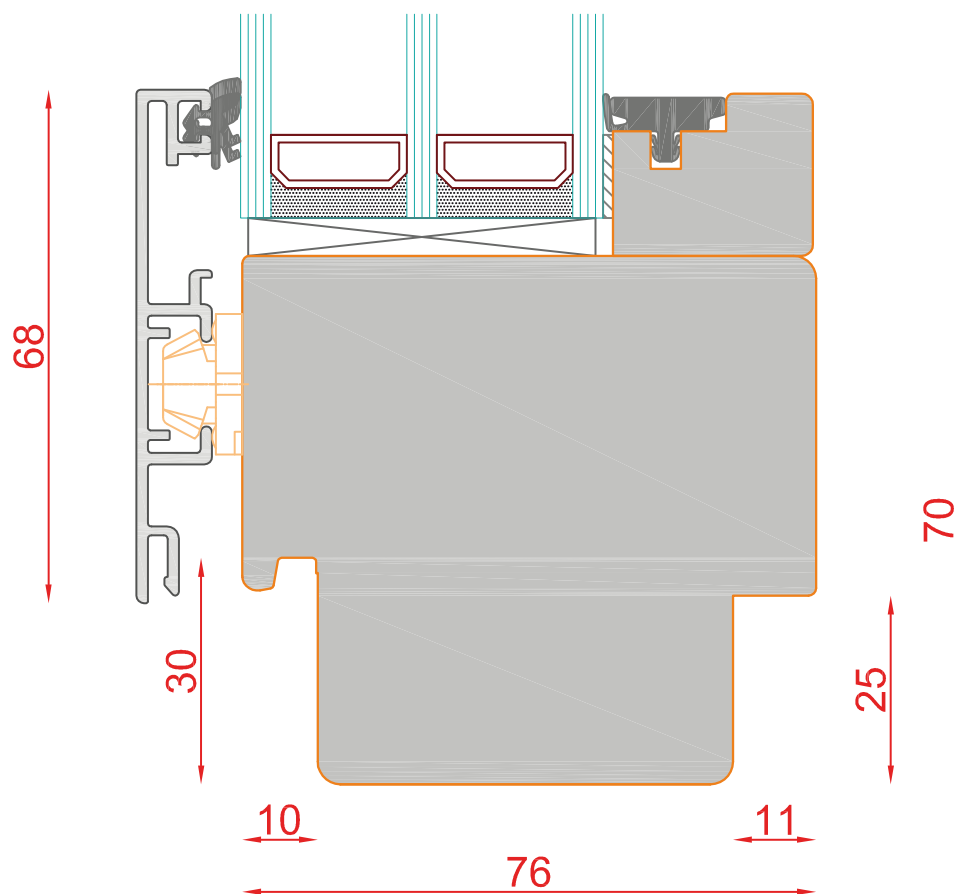
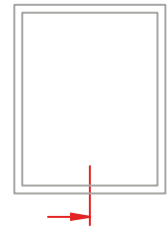

DUO 96
MIT MIRA-SCHALEN

Schnitt : Vertikal unten

Typ: FiB

| Seite: 167

SCHMIDT VISBEK
Fenster. Türen. Innovationen.

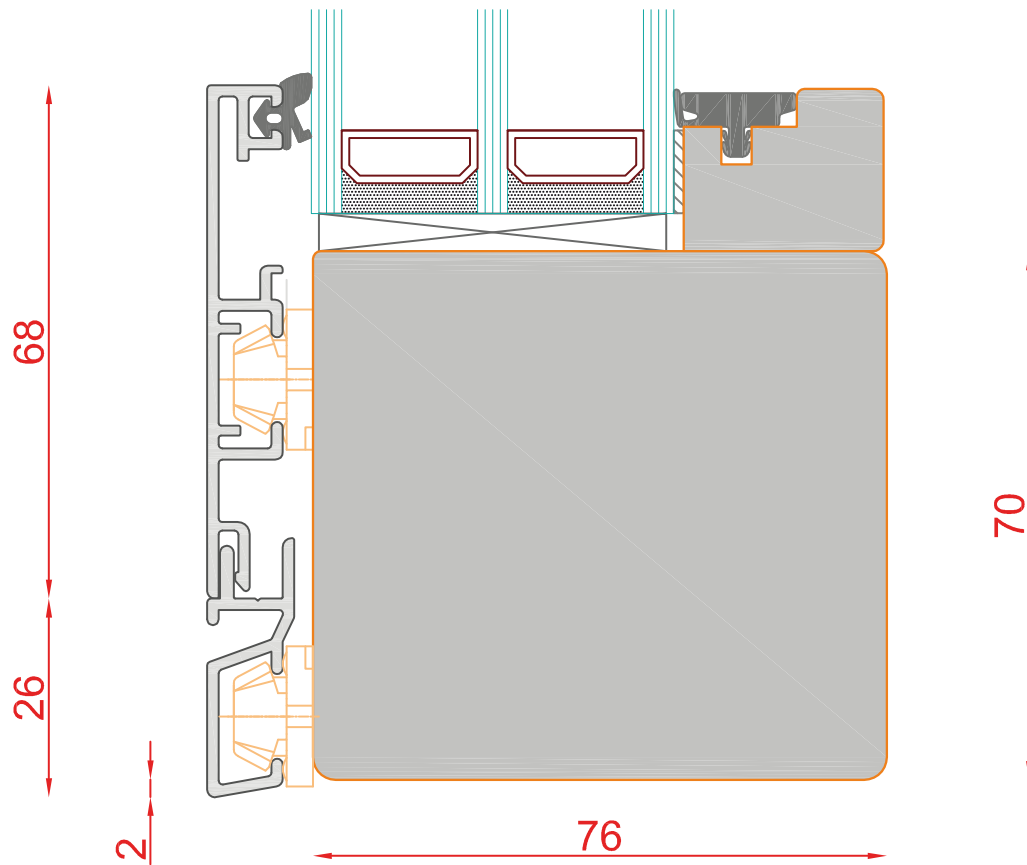
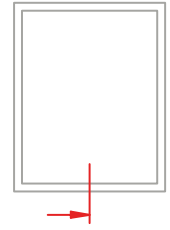

DUO 96
MIT MIRA-SCHALEN

Schnitt : Vertikal unten

Typ: FiB

| Seite: 168

SCHMIDT VISBEK
Fenster. Türen. Innovationen.

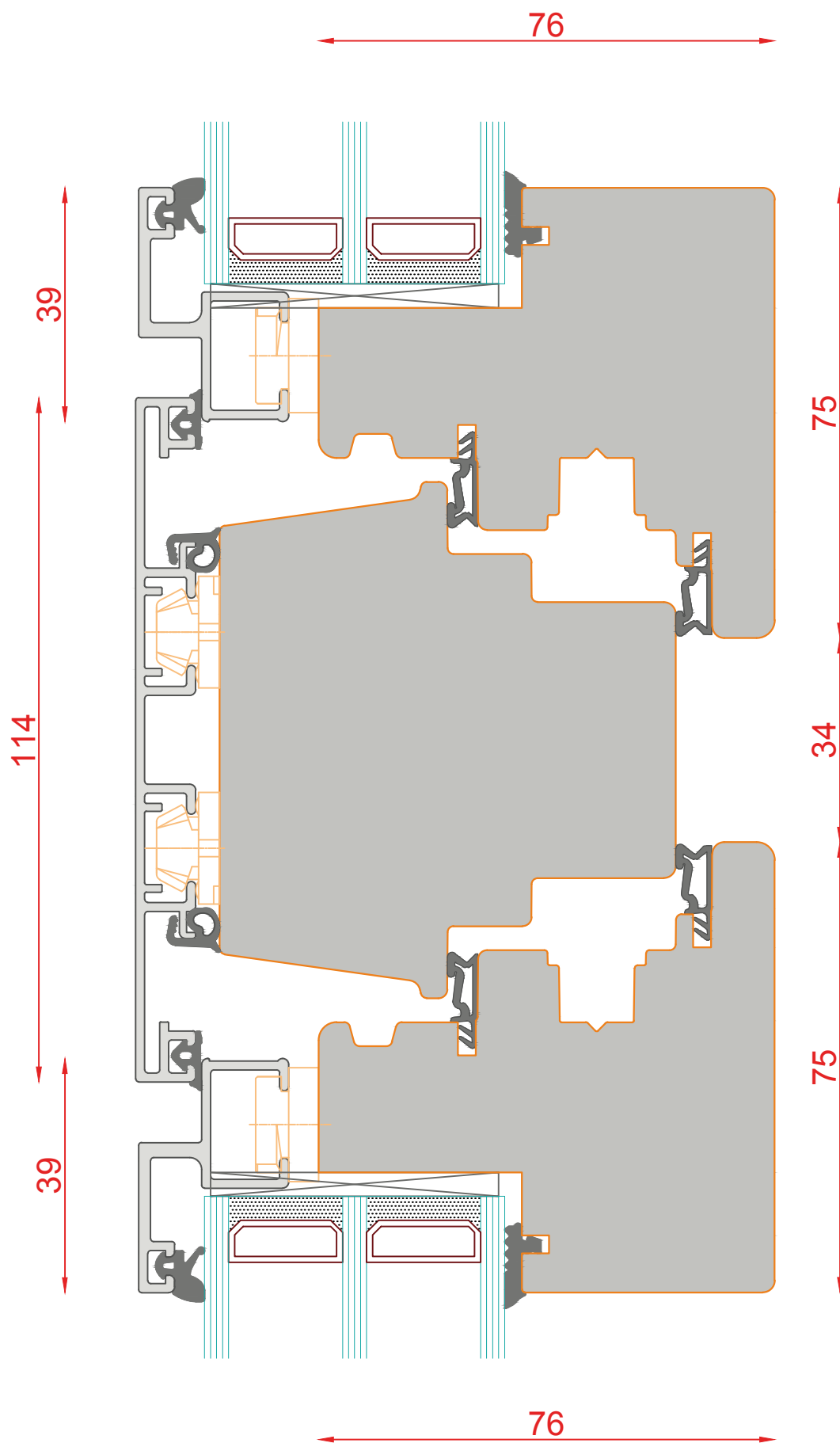
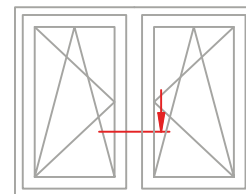

DUO 96
MIT MIRA-SCHALEN

Schnitt : Horizontal Mitte Pfosten

Typ: DK mit Mittelpfosten

| Seite: 169

SCHMIDT VISBEK
Fenster Türen Innenelemente



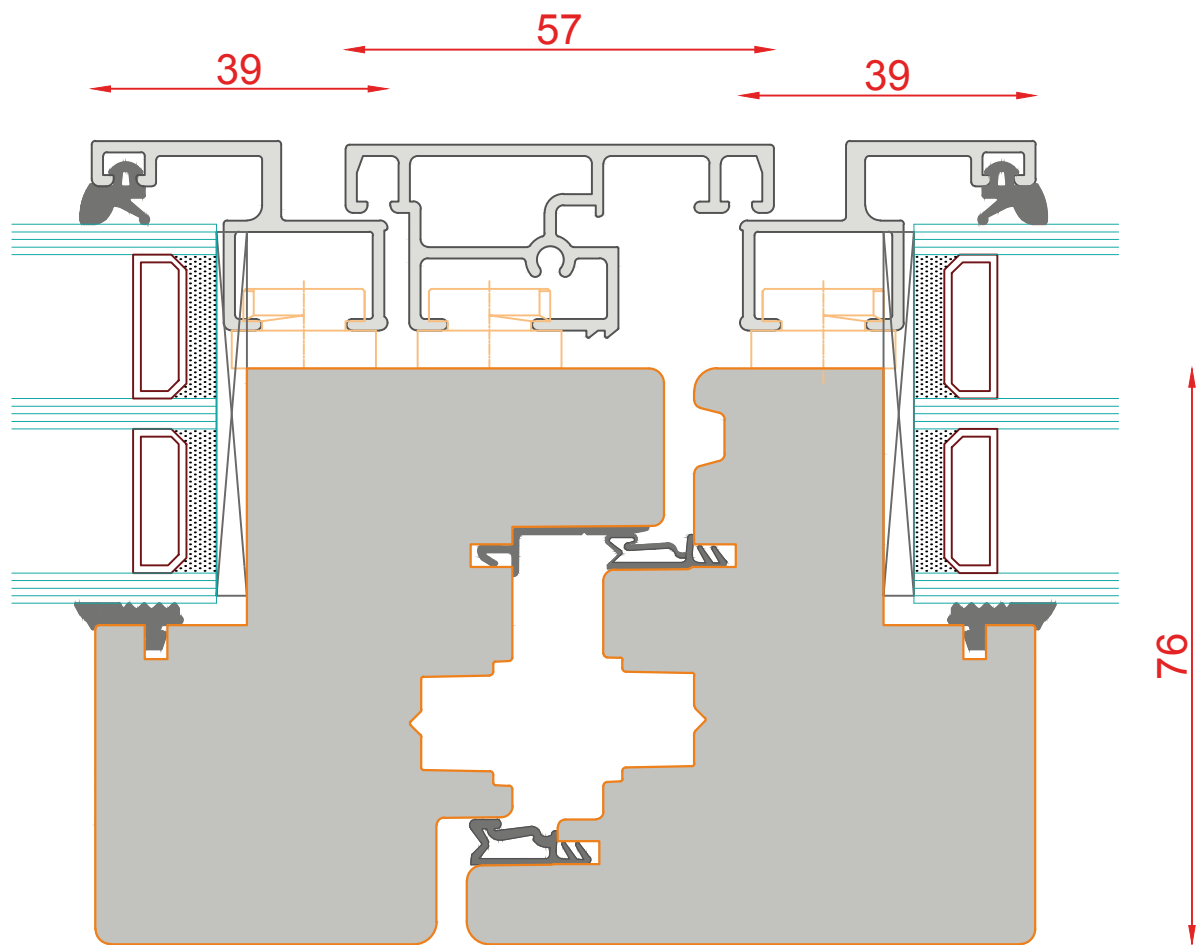
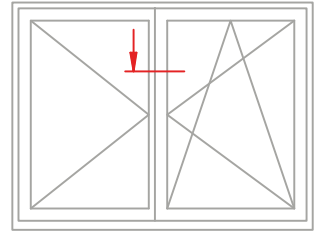

DUO 96
MIT MIRA-SCHALEN

Schnitt : Horizontal Stulp

Typ: DK

| Seite: 170

SCHMIDT VISBEK
Fenster Türen Innenelemente

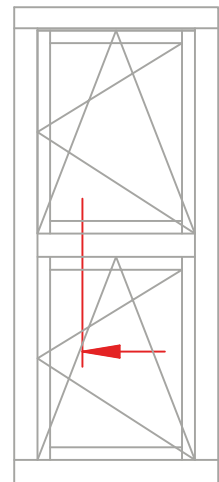
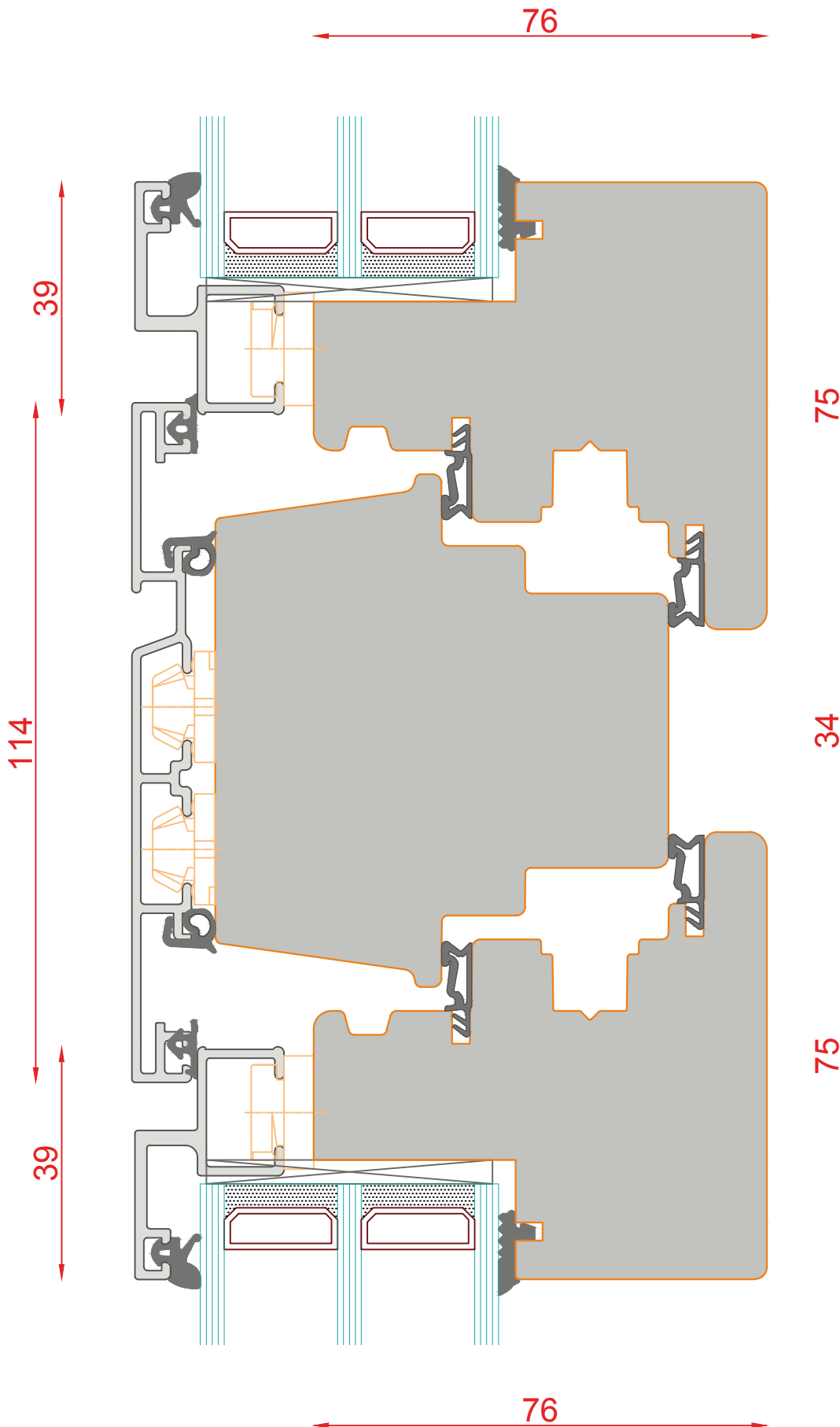

DUO 96
MIT MIRA-SCHALEN

Schnitt : Vertikal

Typ: Kämpfer DK - DK

| Seite: 171

SCHMIDT VISBEK

Fenster Türen Innenelemente

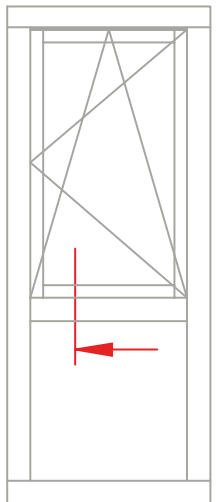
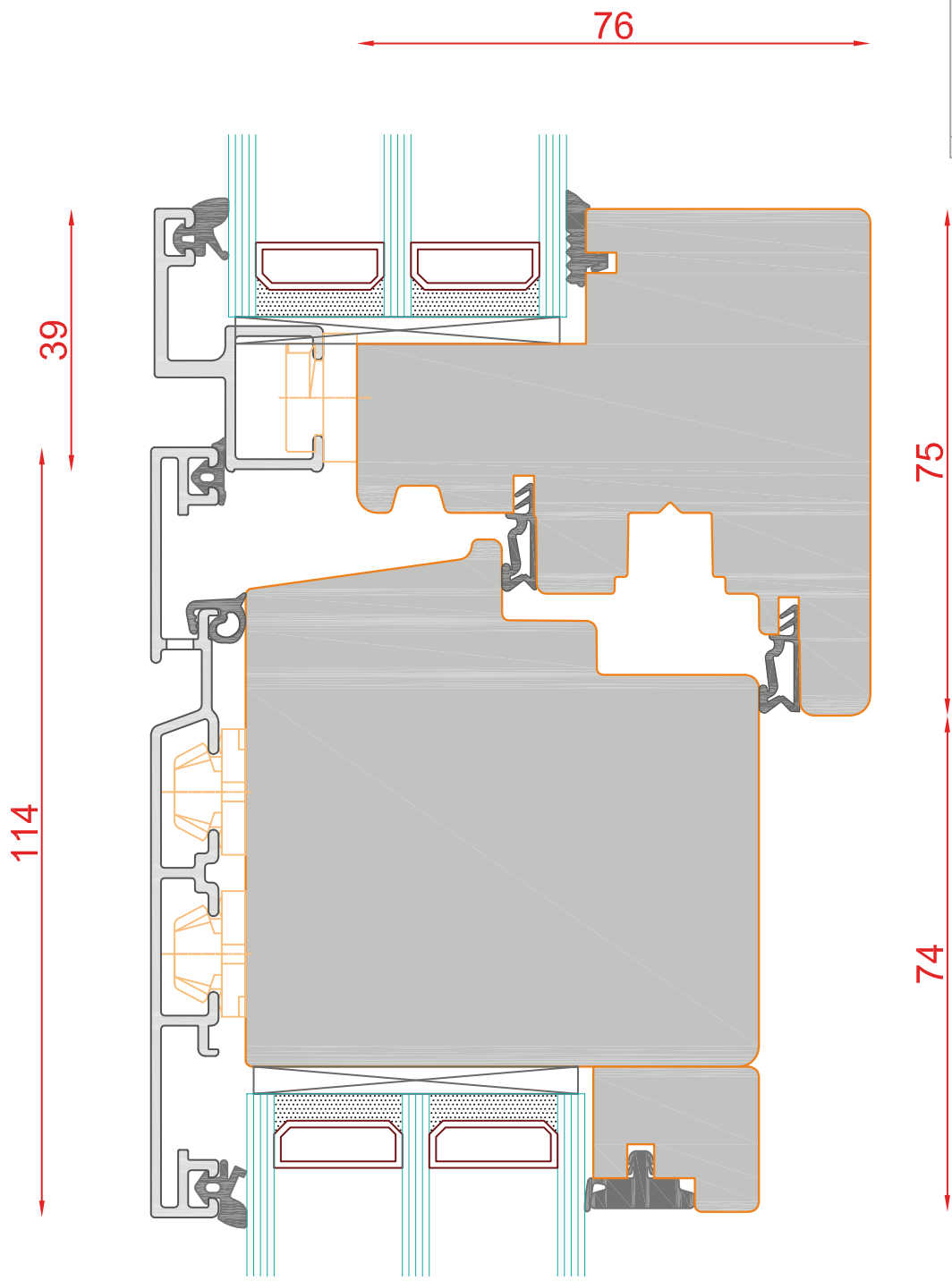

DUO 96
MIT MIRA-SCHALEN

Schnitt : Vertikal Kämpfer DK-FIB

Typ: FiB

| Seite: 172

SCHMIDT VISBEK
Fenster. Türen. Innovationen.

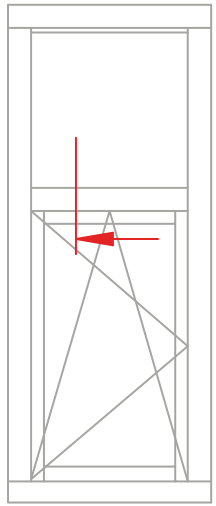
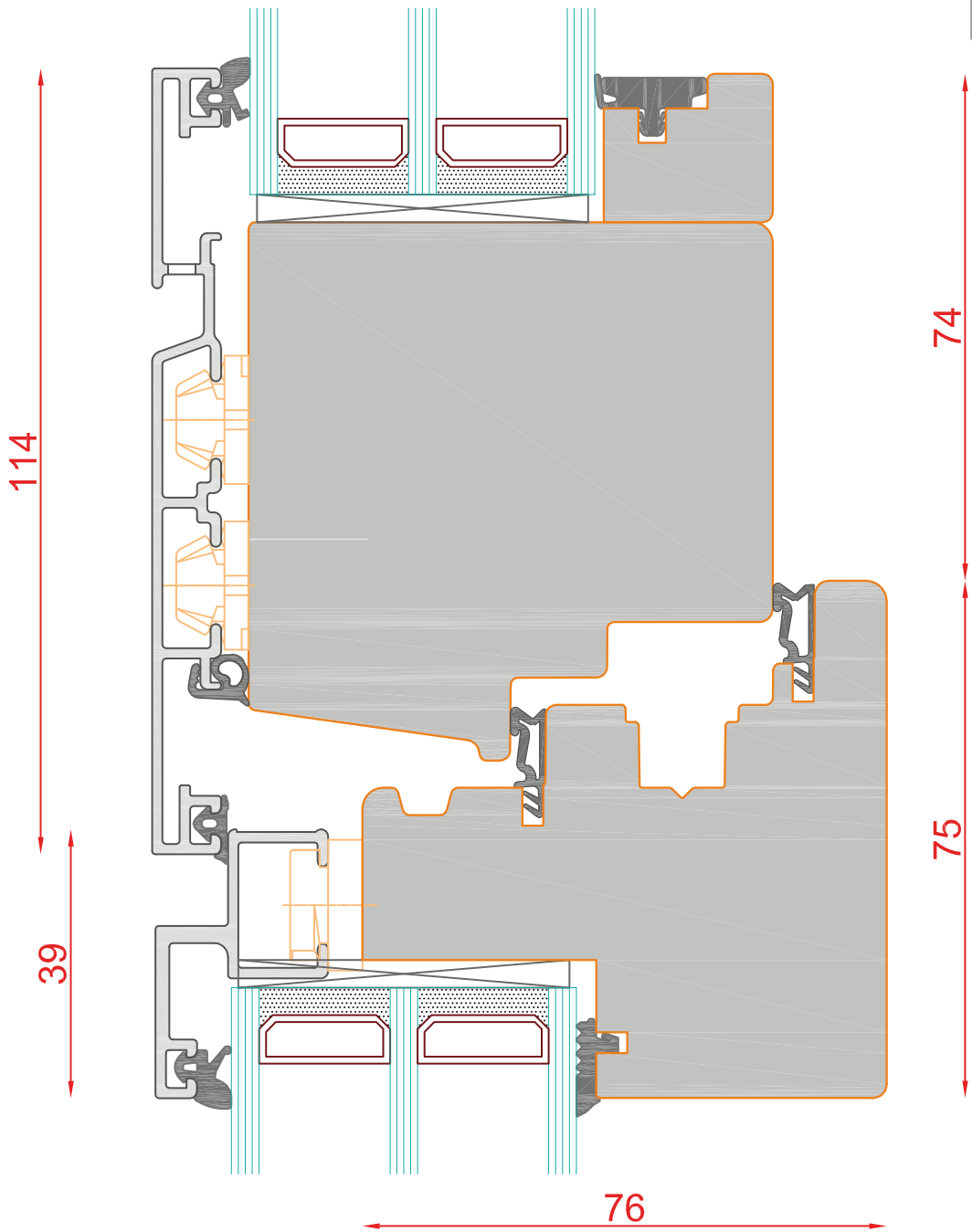

DUO 96
MIT MIRA-SCHALEN

Schnitt : Vertikal Kämpfer DK-FIB

Typ: FiB

| Seite: 173

SCHMIDT VISBEK
Fenster. Türen. Innovationen.

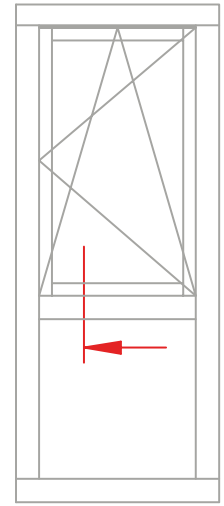
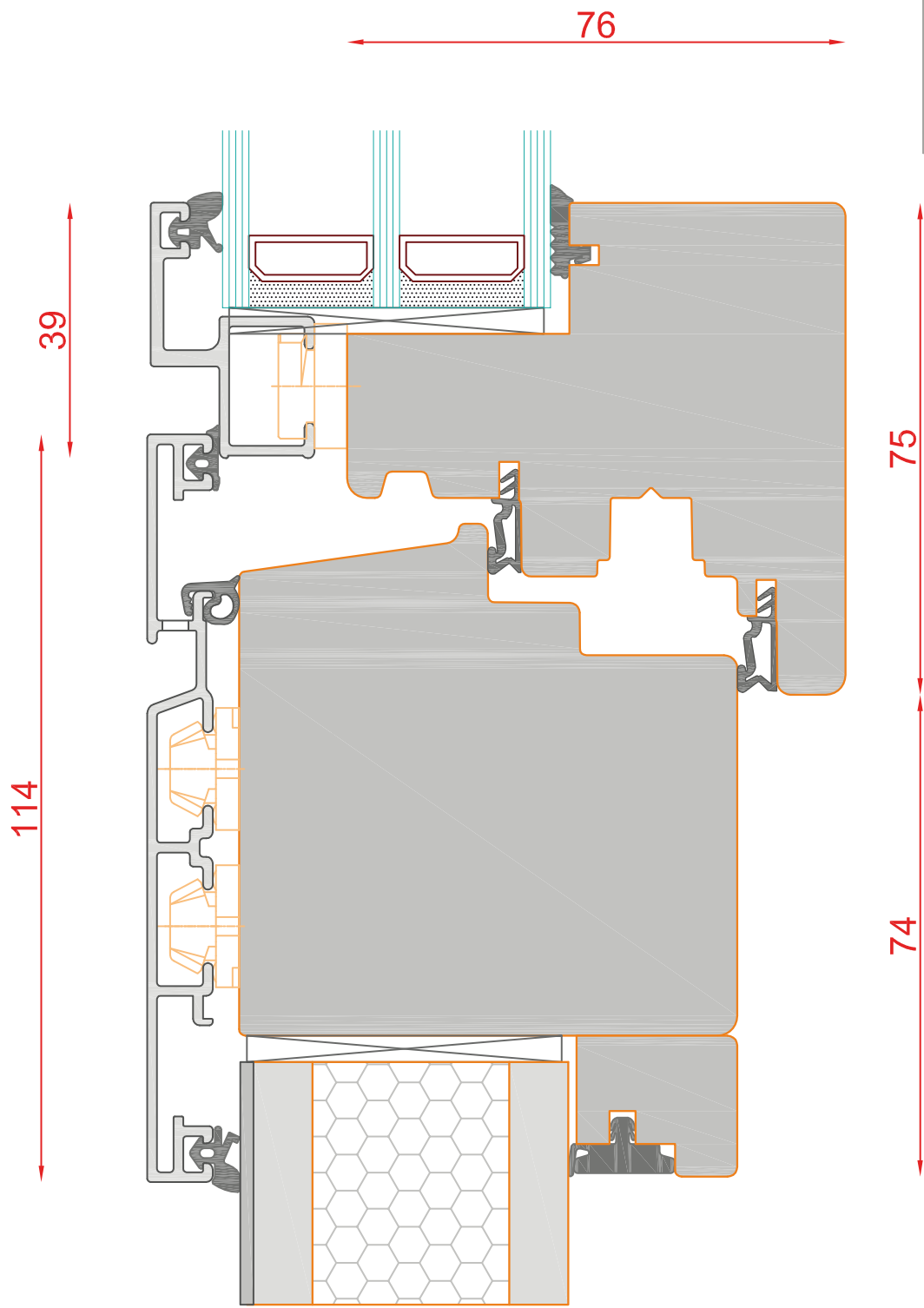

DUO 96
MIT MIRA-SCHALEN

Schnitt : Vertikal Kämpfer DK-FIB

Typ: Füllung

| Seite: 174

SCHMIDT VISBEK
Fenster. Türen. Innovationen.

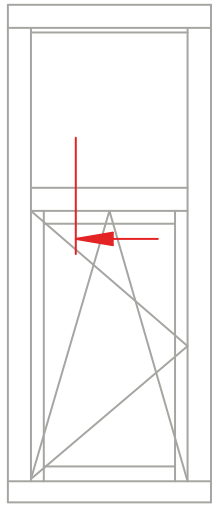
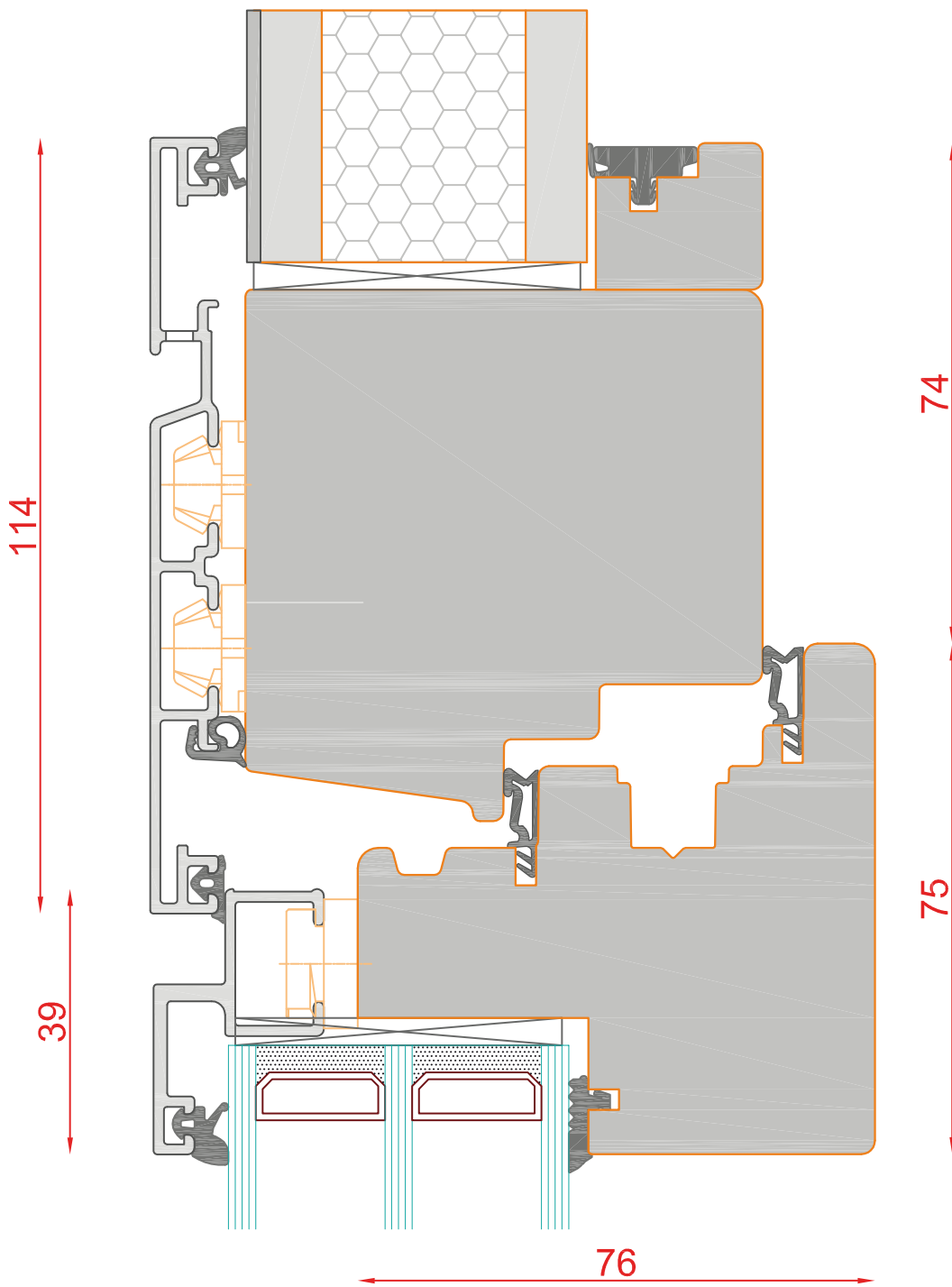

DUO 96
MIT MIRA-SCHALEN

Schnitt : Vertikal Kämpfer DK-FIB

Typ: Füllung

| Seite: 175

SCHMIDT VISBEK
Fenster. Türen. Innovationen.

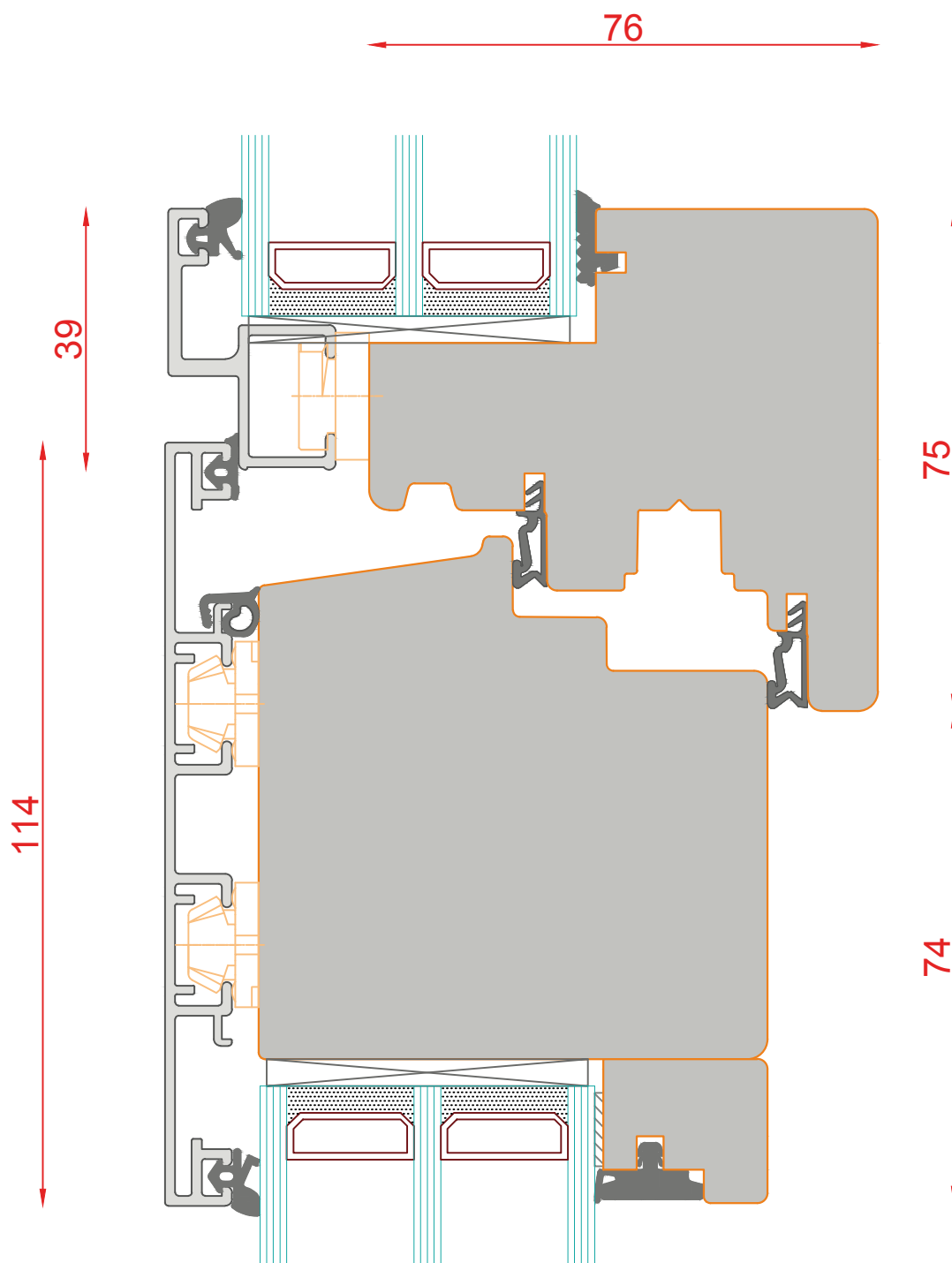
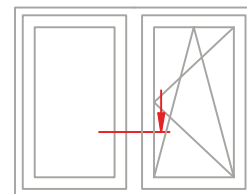

DUO 96
MIT MIRA-SCHALEN

Schnitt : Horizontal Mitte

Typ: DK - FIB

| Seite: 176

SCHMIDT VISBEK
Fenster Türen Innenelemente

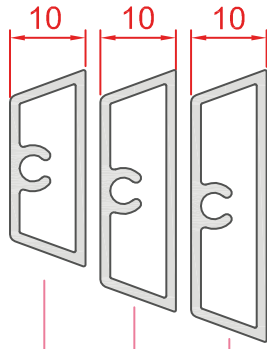

SP 36.10 = 36mm
 SP 32.10 = 32mm
 SP 26.10 = 26mm

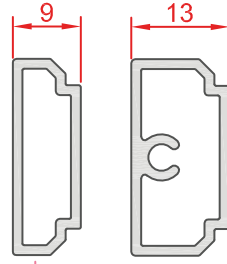

SP 26.13-SK = 26mm
 SP 26.9-SK = 26mm

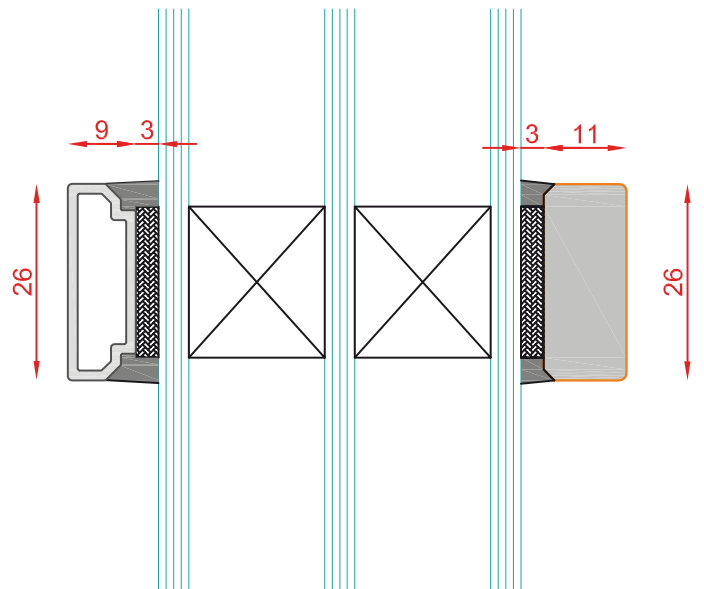
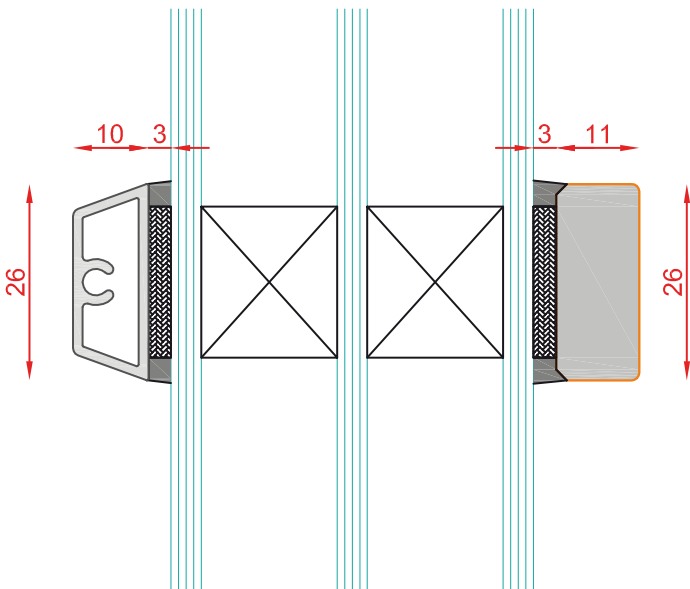
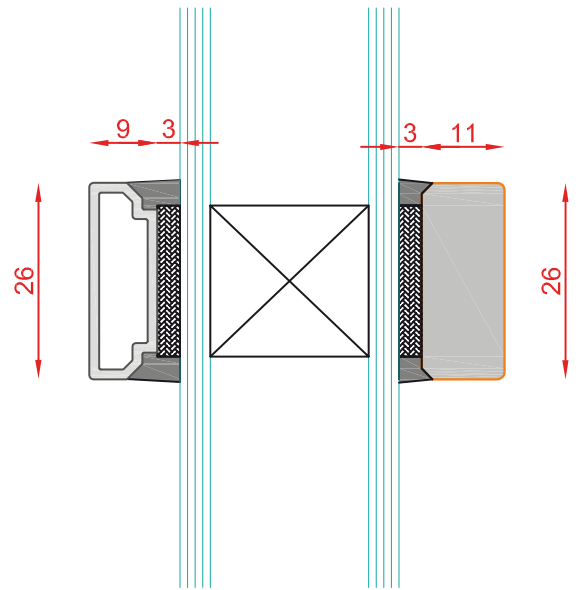
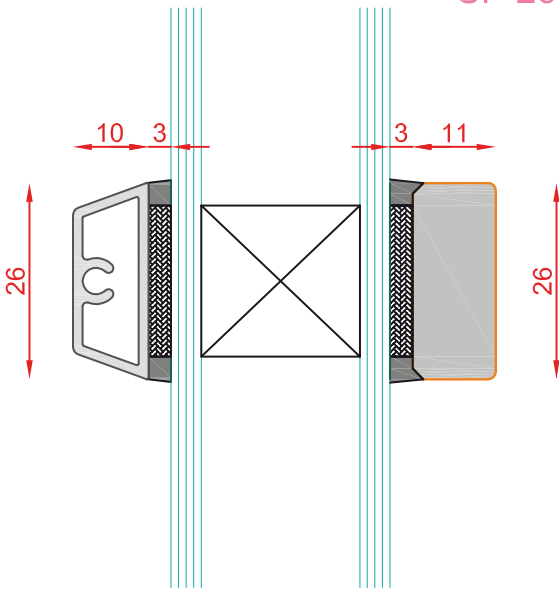

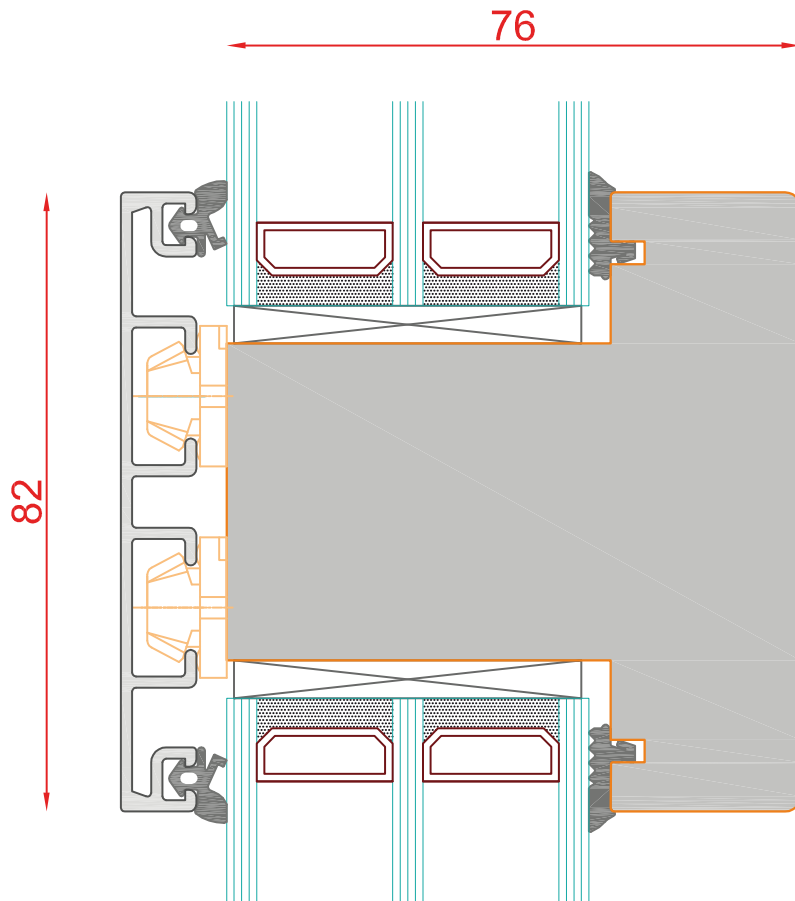
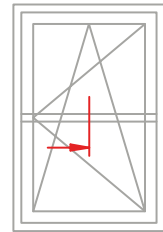

DUO 96
MIT MIRA-SCHALEN

Schnitt : Sprosse Glasteilend

Typ: Flügel

| Seite: 178

SCHMIDT VISBEK
Fenster. Türen. Innovationen.

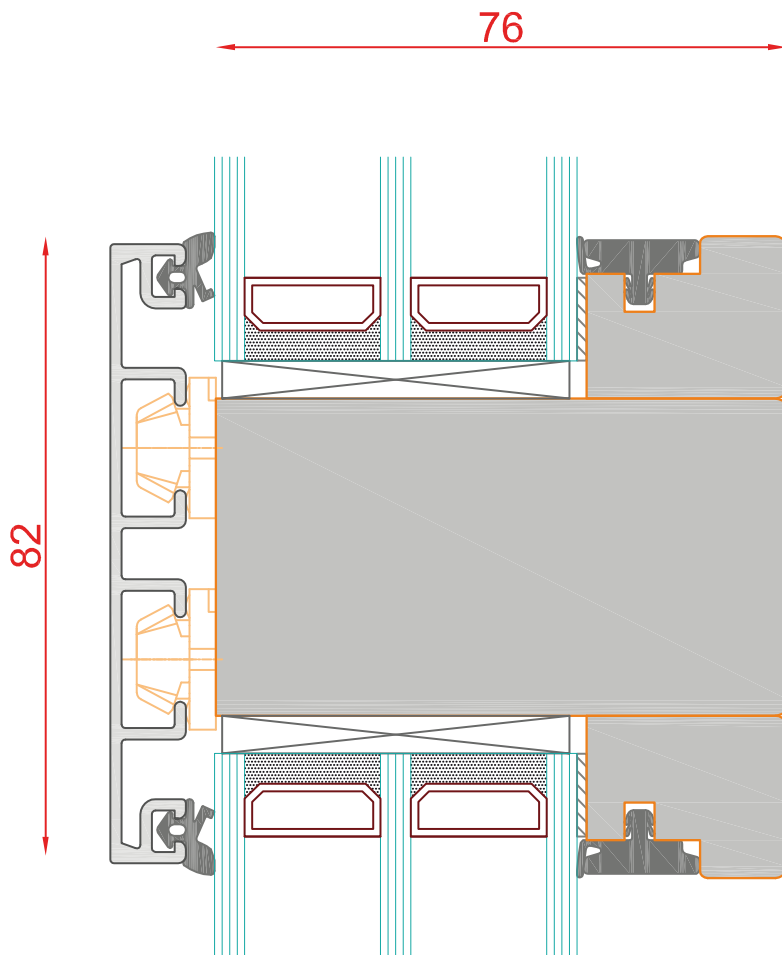
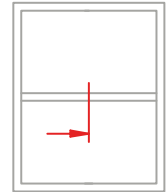

DUO 96
MIT MIRA-SCHALEN

Schnitt : Sprosse Glasteilend

Typ: Blendrahmen

| Seite: 179

SCHMIDT VISBEK
Fenster. Türen. Innovationen.

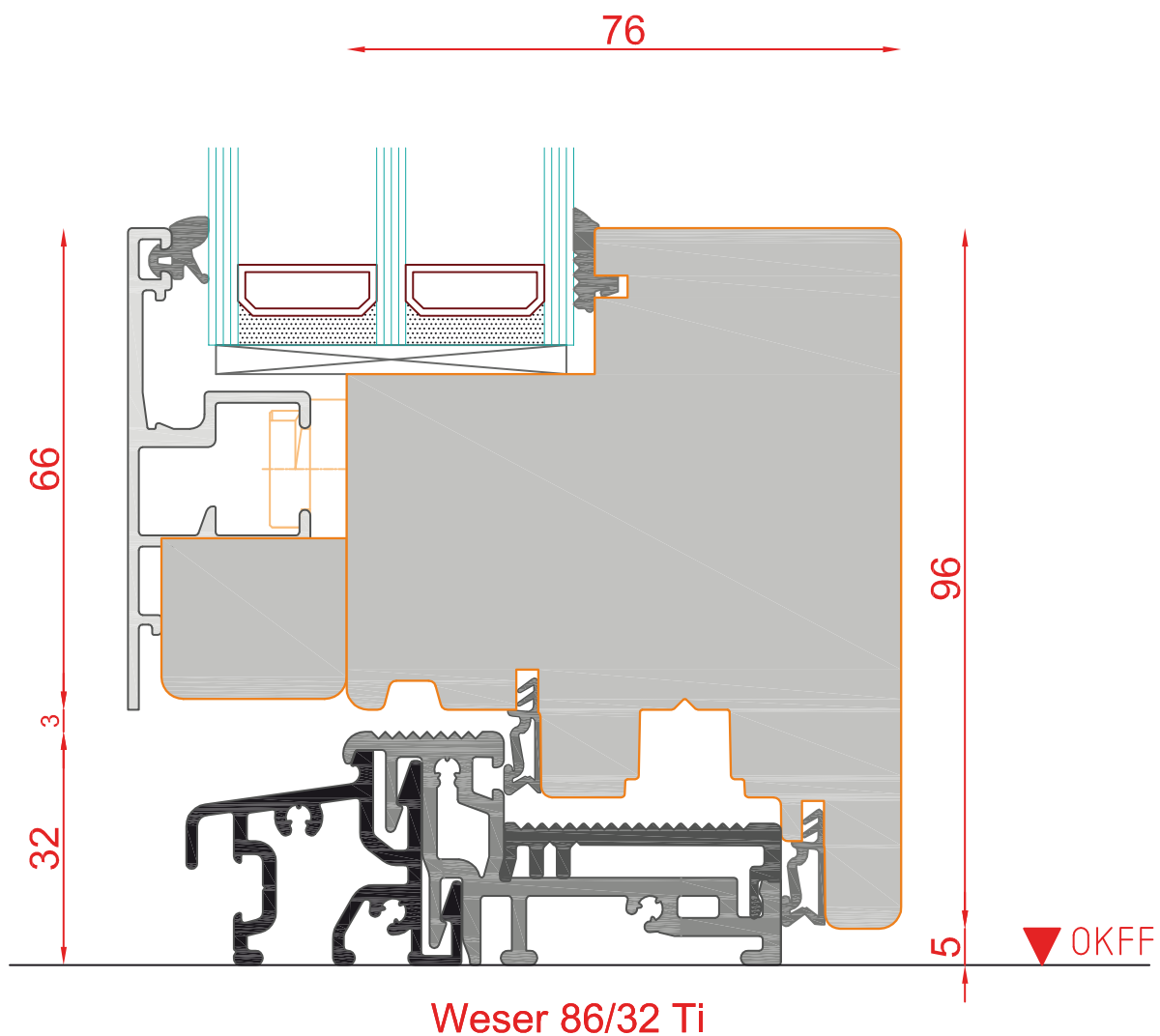
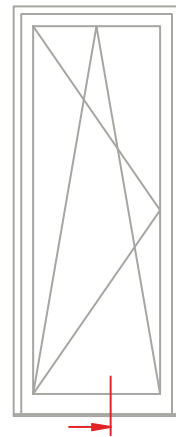

DUO 96
MIT MIRA-SCHALEN

Schnitt : Vertikal unten

Typ: DK- Tür mit Weser Schiene | Seite: 180

SCHMIDT VISBEK
Fenster. Türen. Innovationen.

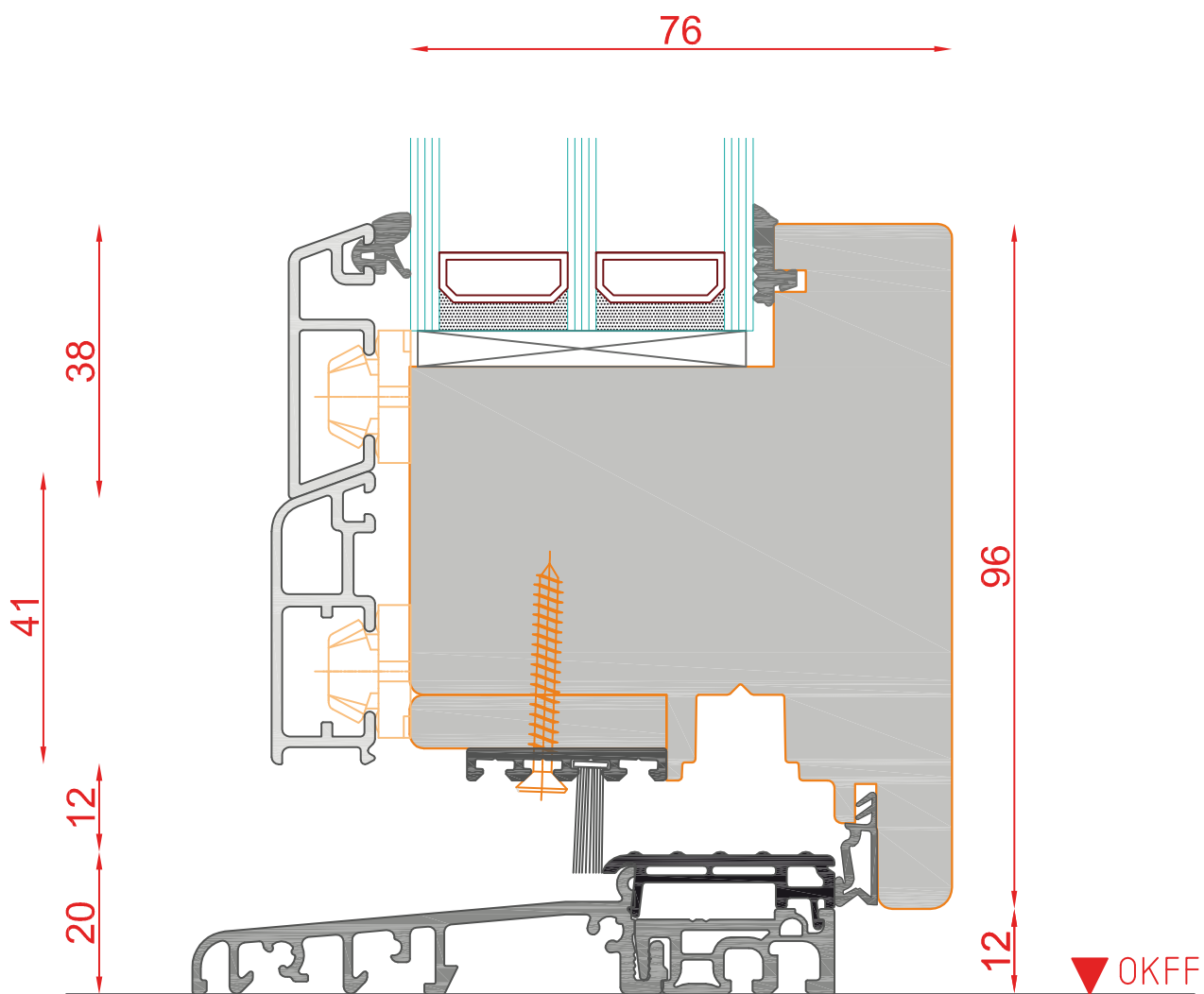
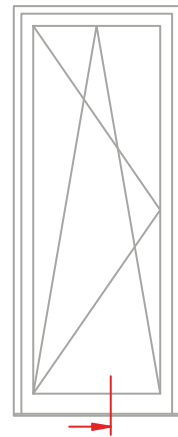

Bodenschwelle BKV Eifel 90 TB



DUO 96
MIT MIRA-SCHALEN

Schnitt : Vertikal unten

Eifel Schiene 20mm

| Seite: 181

SCHMIDT VISBEK
Fenster. Türen. Innovationen.

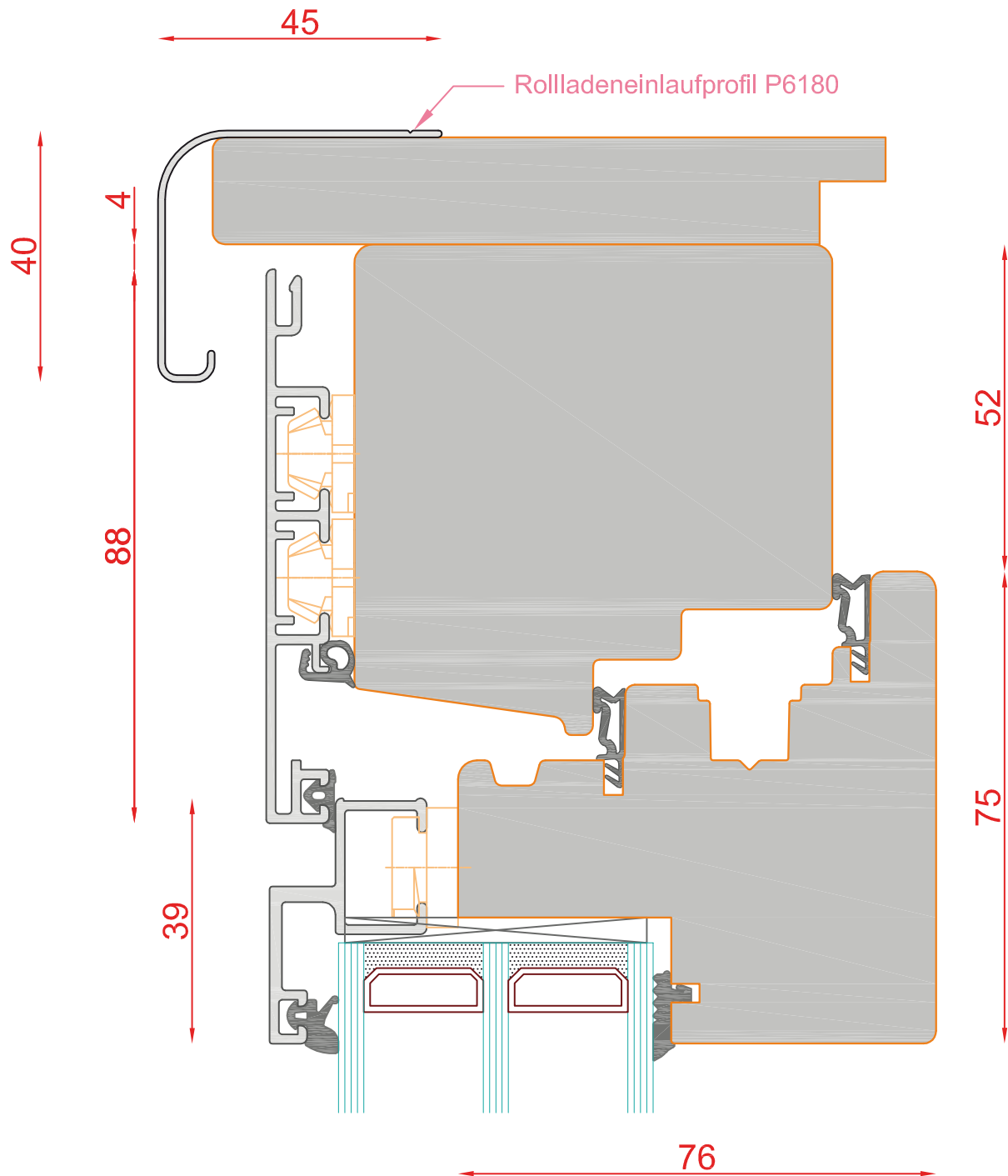
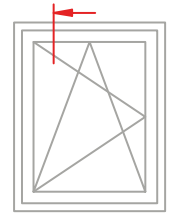

DUO 96
MIT MIRA-SCHALEN

Schnitt : Horizontal seitlich und oben

Typ: DK

| Seite: 182

SCHMIDT VISBEK
Fenster. Türen. Innovationen.

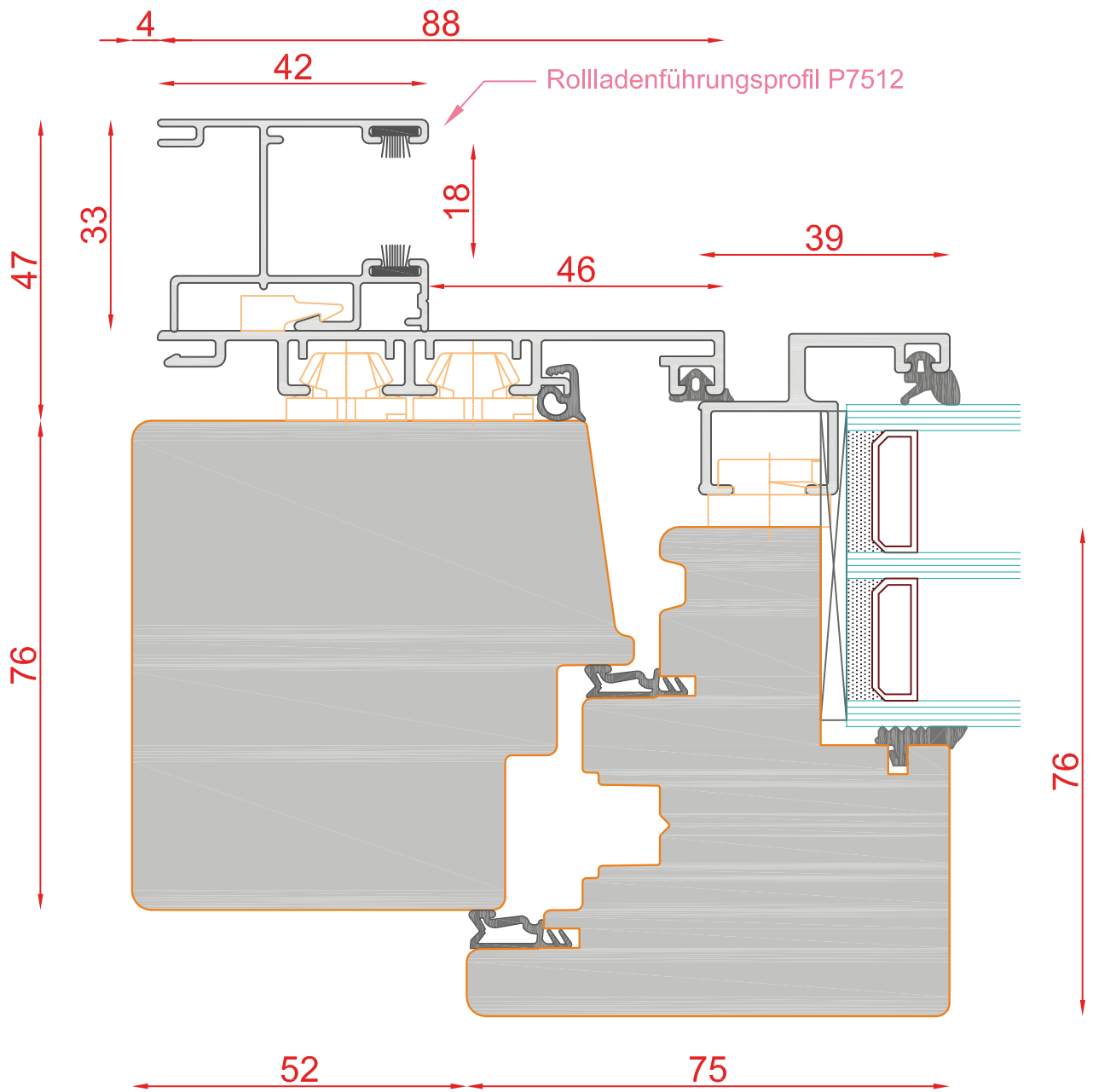
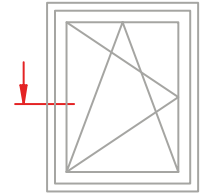

DUO 96
MIT MIRA-SCHALEN

Schnitt : Horizontal seitlich und oben

Typ: DK

| Seite: 183

SCHMIDT VISBEK
Fenster. Türen. Innovationen.

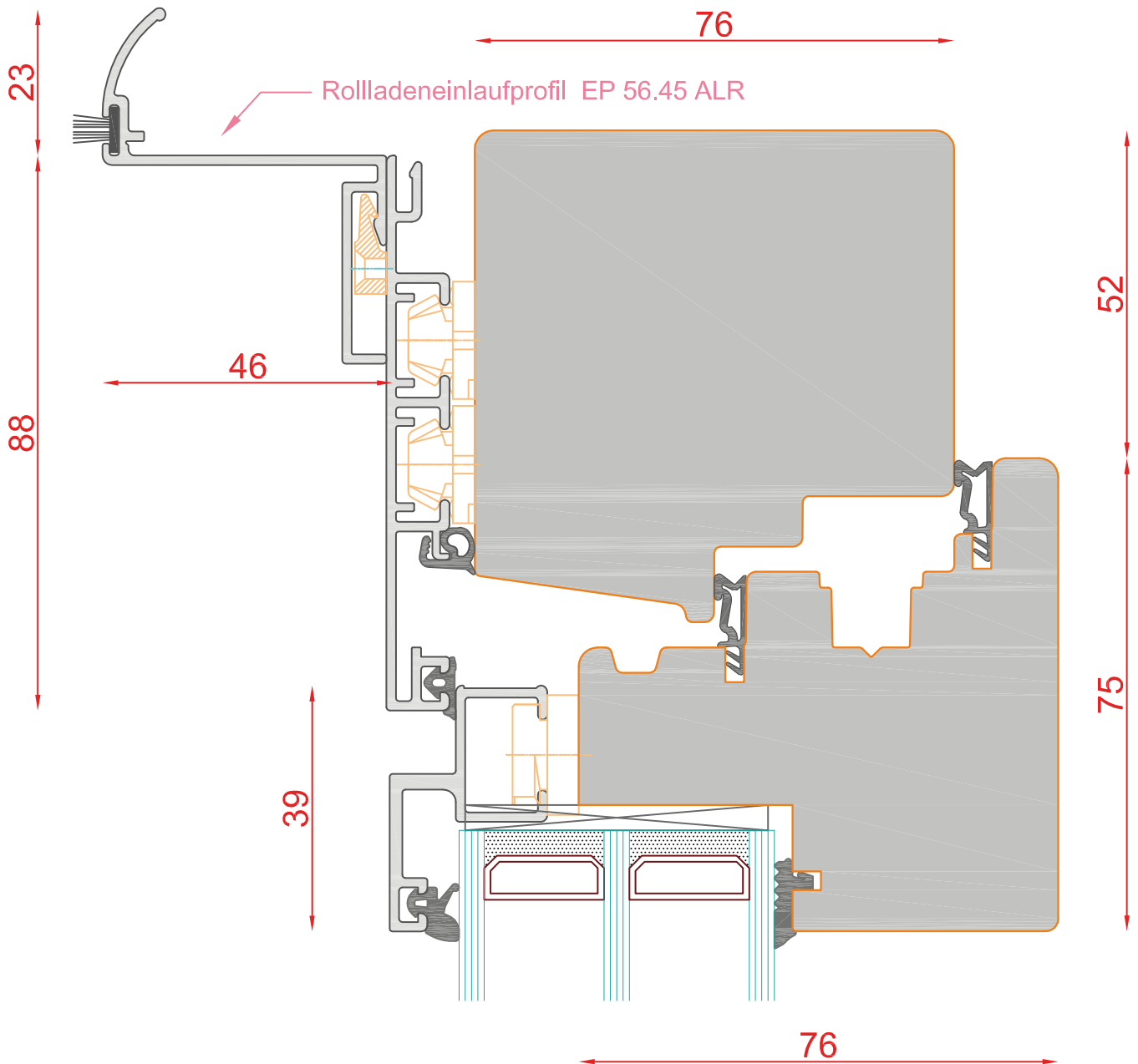
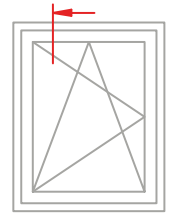

DUO 96
MIT MIRA-SCHALEN

Schnitt : Horizontal seitlich und oben

Typ: DK

| Seite: 184

SCHMIDT VISBEK
Fenster. Türen. Innovationen.

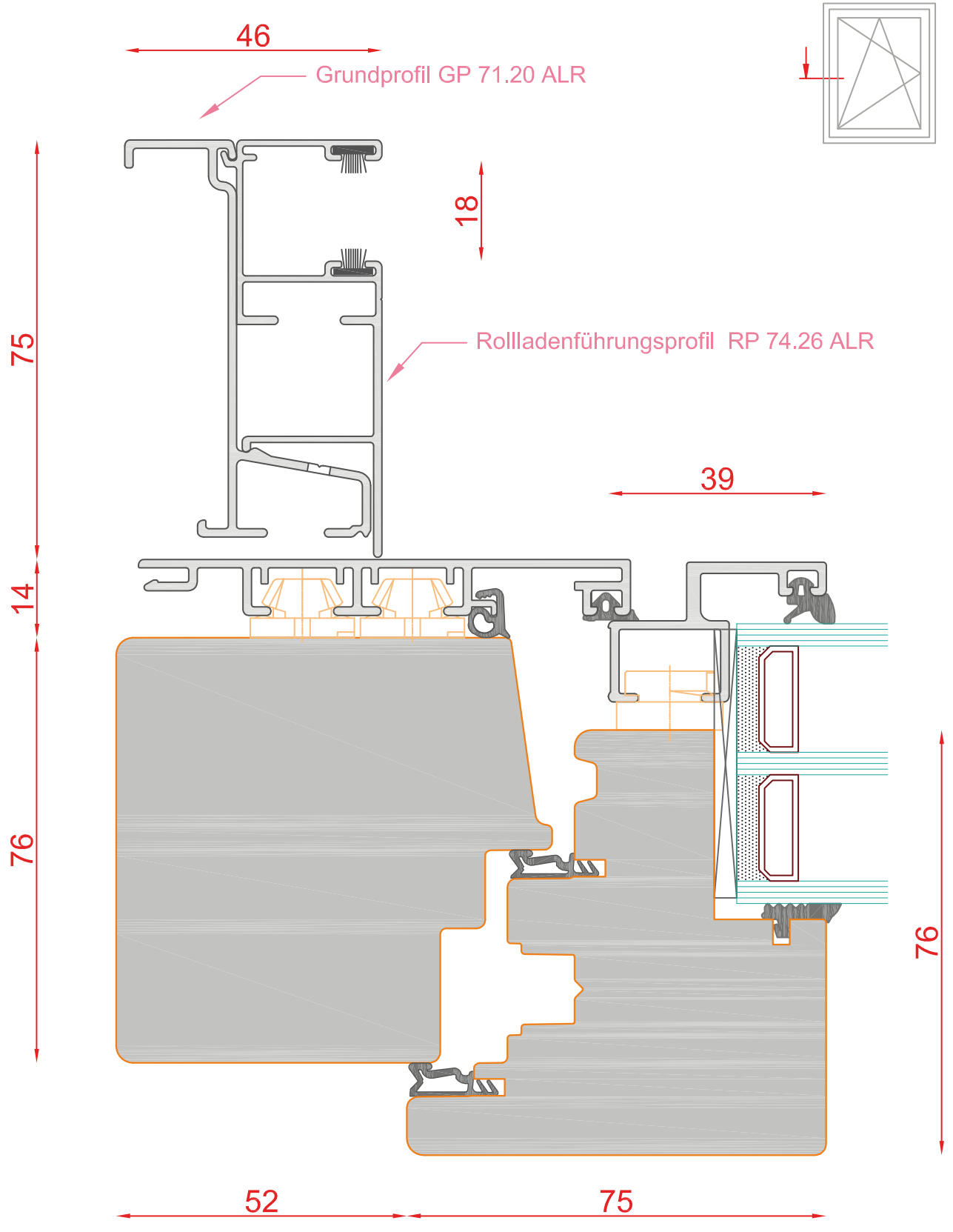

DUO 96
MIT MIRA-SCHALEN

Schnitt : Horizontal seitlich und oben

Typ: DK

| Seite: 185

SCHMIDT VISBEK
Fenster. Türen. Innovationen.

DUO 83

Plano

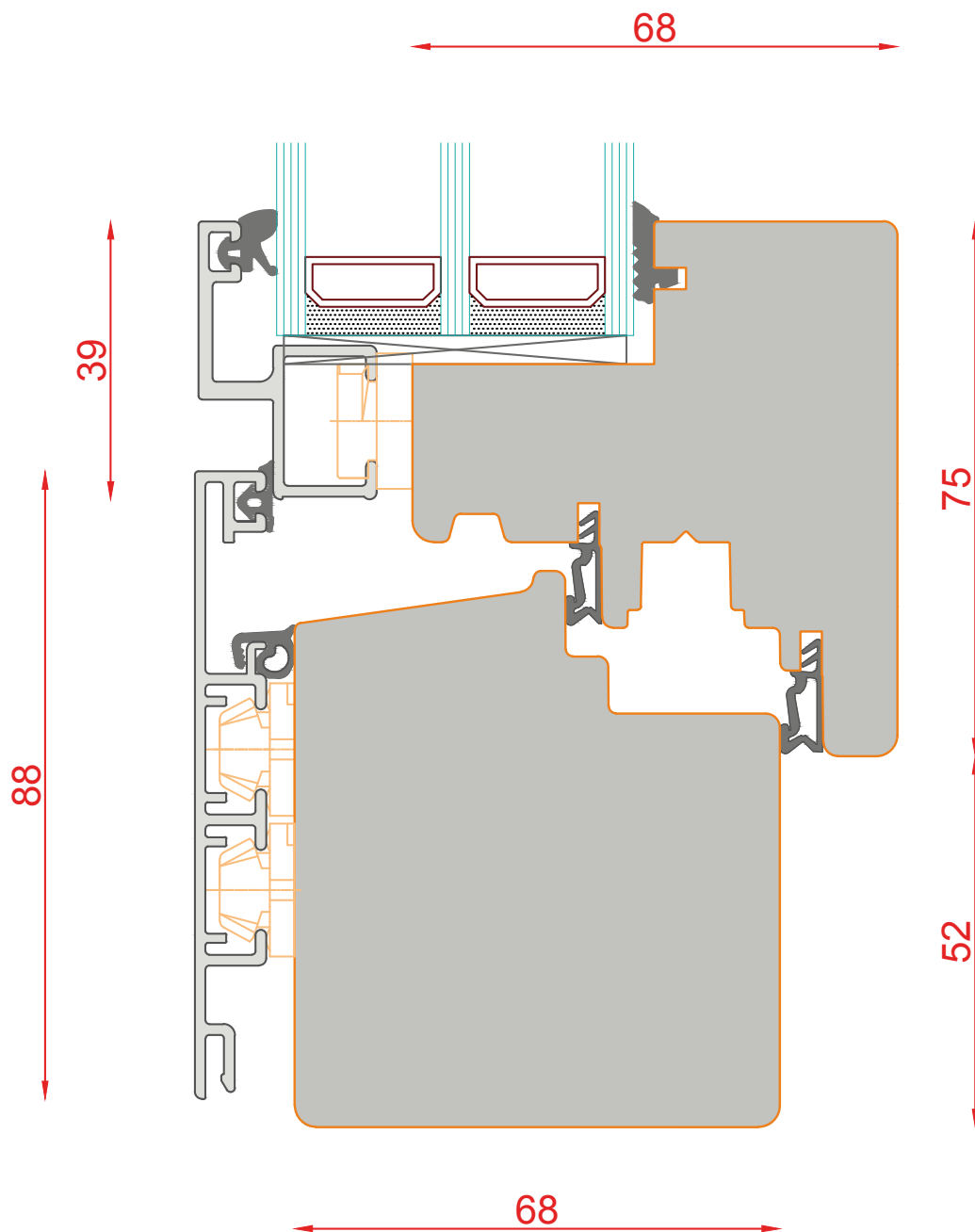
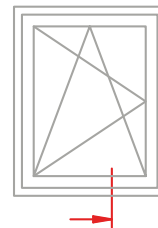

DUO 83
PLANO

Schnitt : Vertikal unten

Typ: DK

| Seite: 187

SCHMIDT VISBEK
Fenster. Türen. Innovalieren.



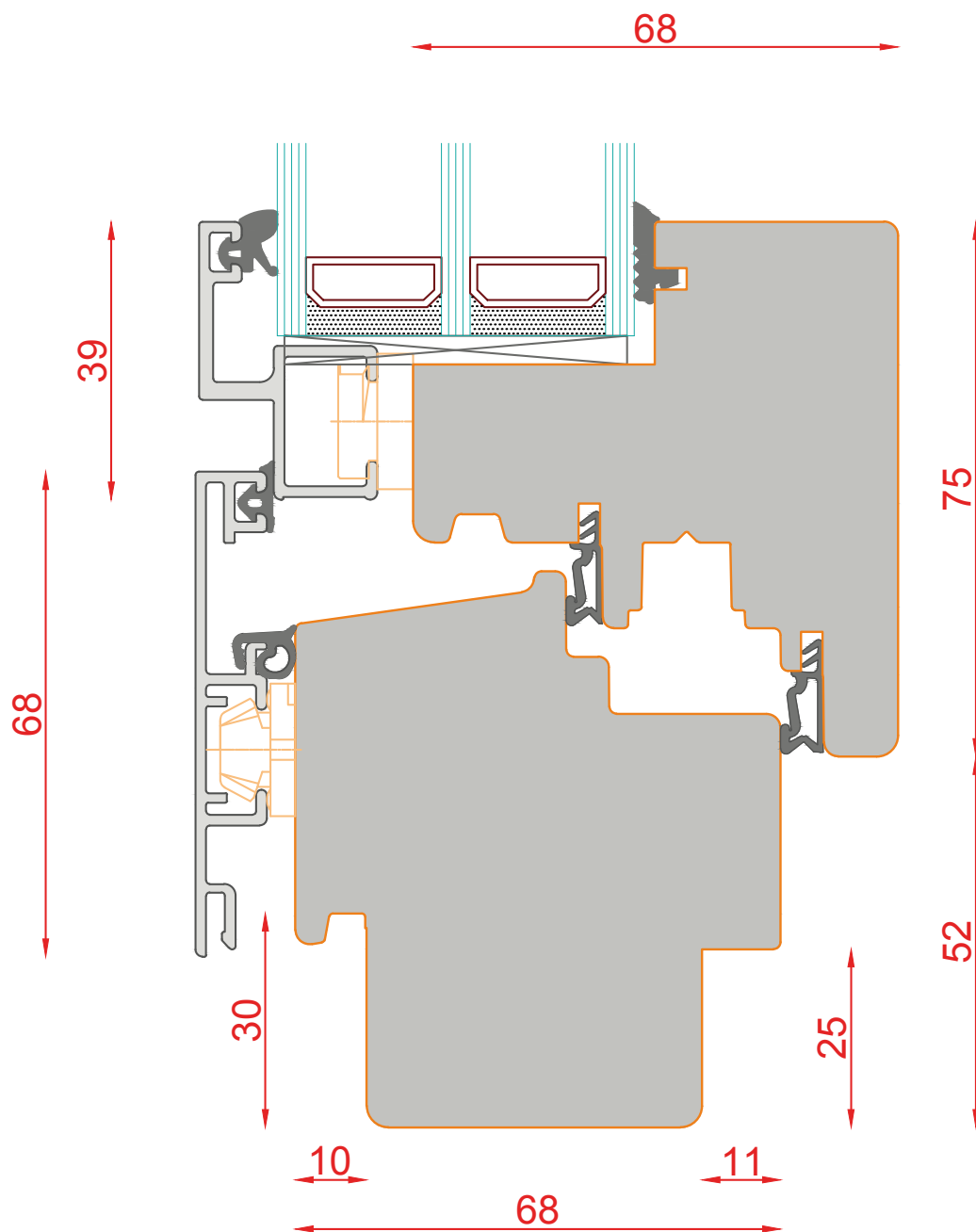
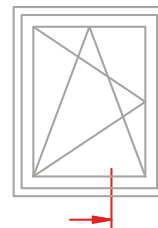

DUO 83
PLANO

Schnitt : Vertikal unten

Typ: DK mit Fensterbankfalz | Seite: 188

SCHMIDT VISBEK
Fenster · Türen · Innovalieren.



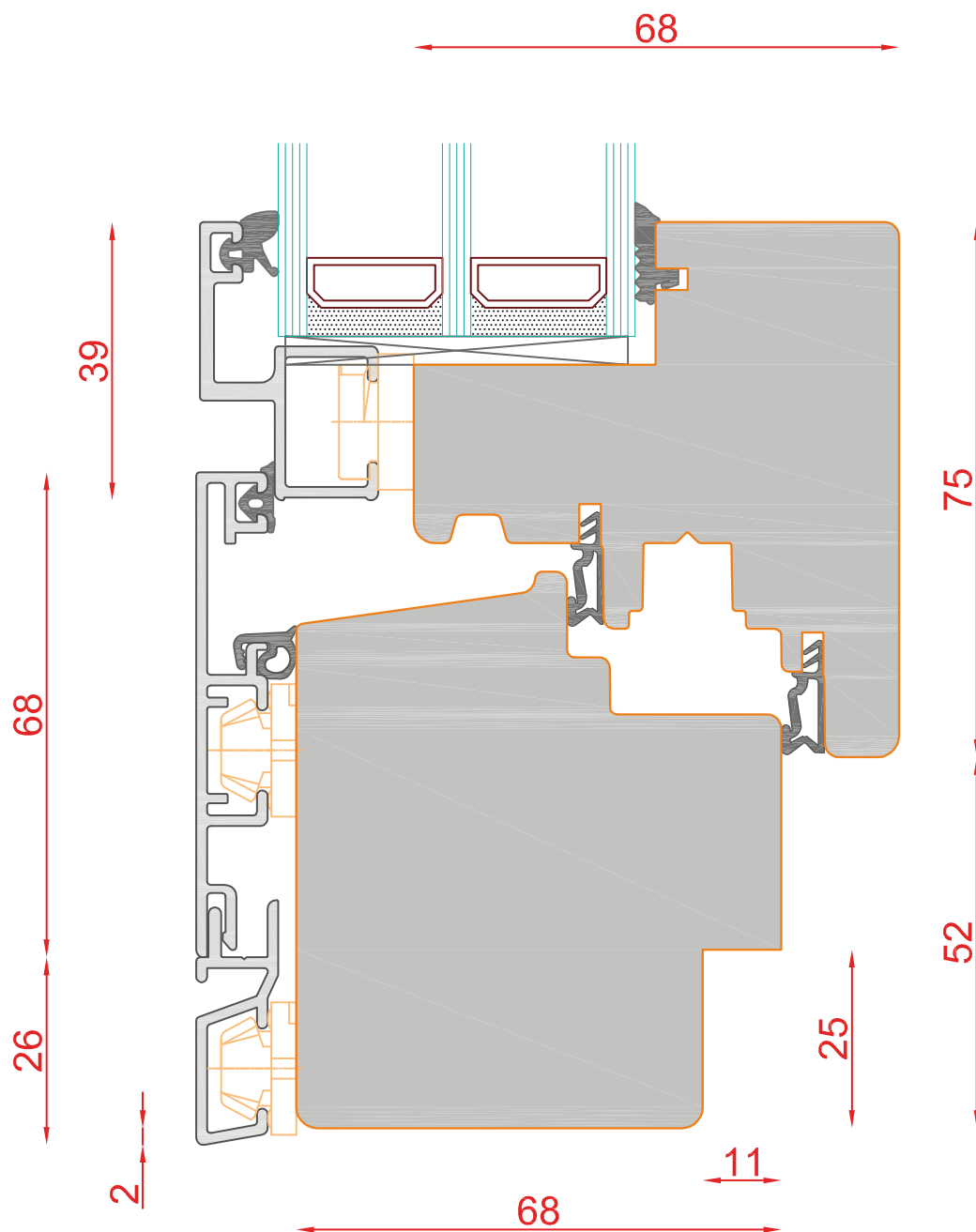
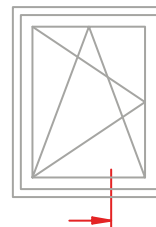

DUO 83
PLANO

Schnitt : Vertikal unten

Typ: DK mit Steinbankanschluss | Seite: 189

SCHMIDT VISBEK
Fenster. Türen. Innovationen.



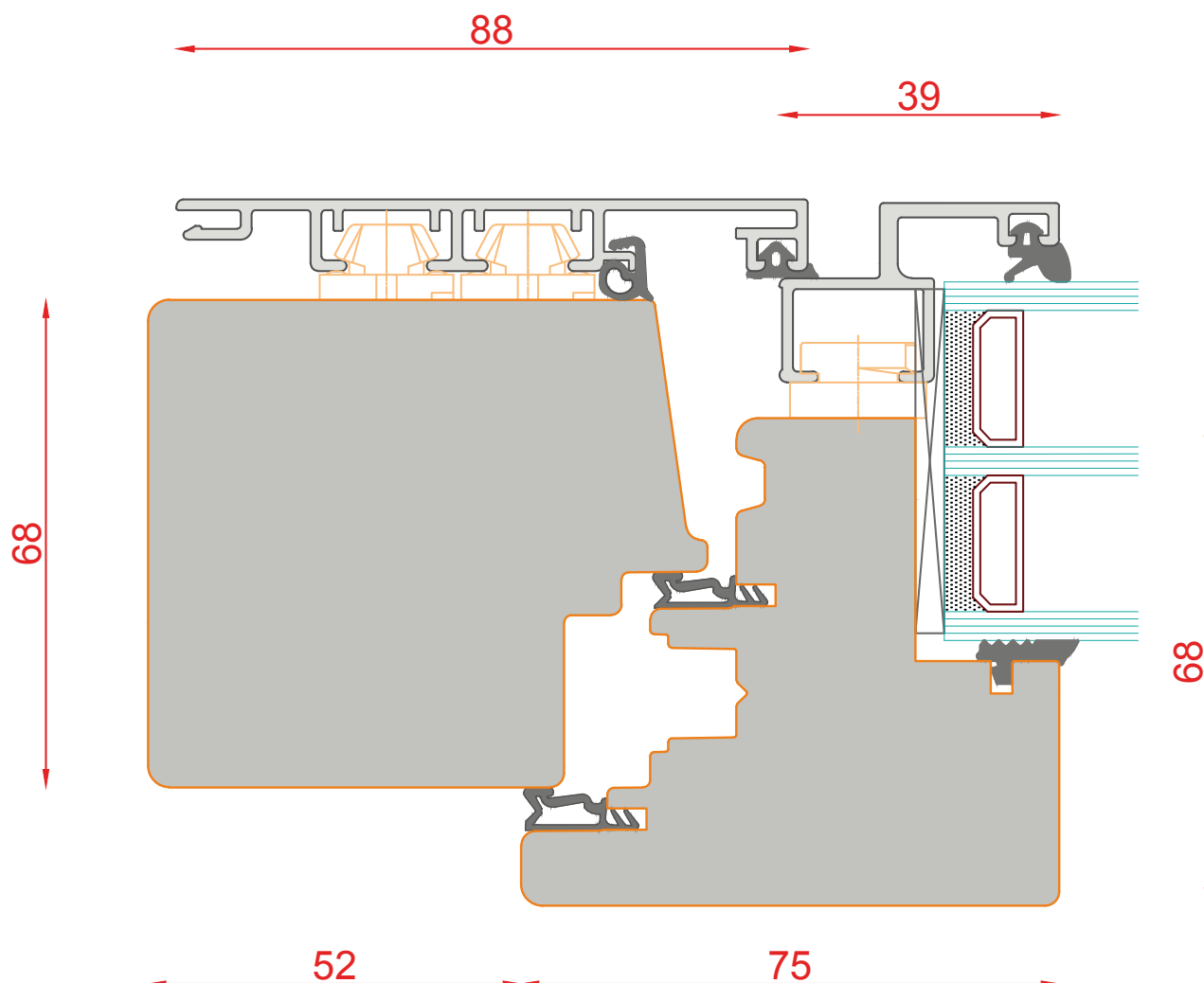
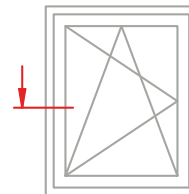

DUO 83
PLANO

Schnitt : Horizontal seitlich und oben

Typ: DK

| Seite: 190

SCHMIDT VISBEK
Fenster, Türen, Innenelemente.

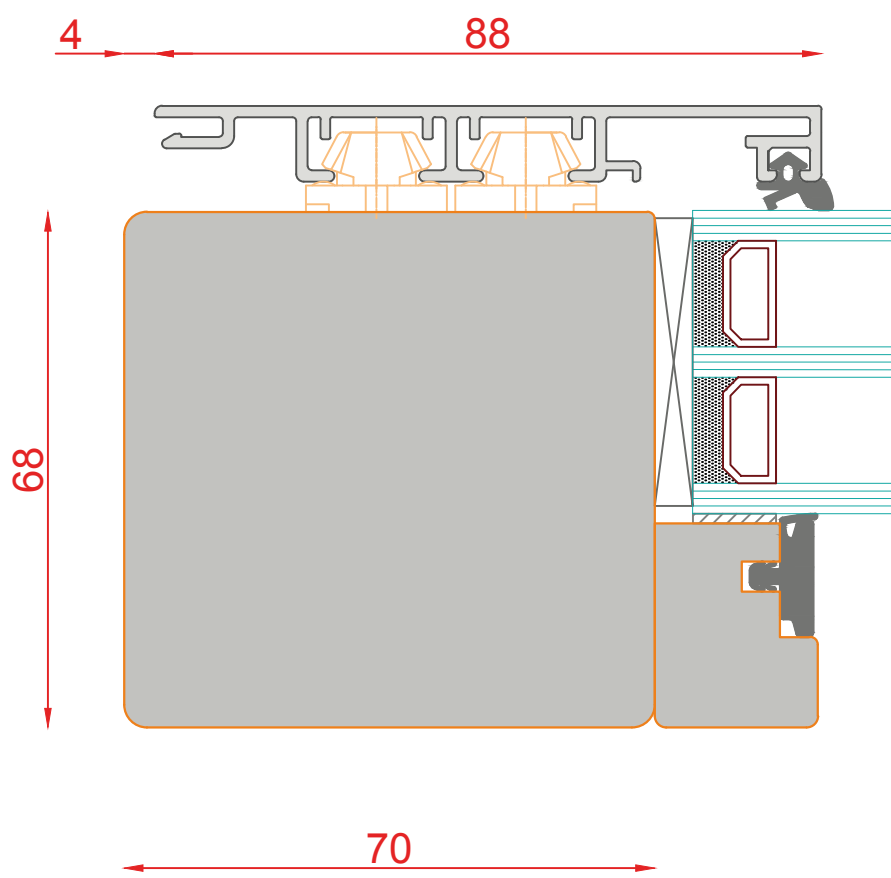
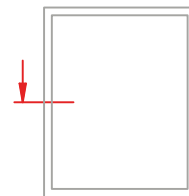

DUO 83
PLANO

Schnitt : Horizontal seitlich und oben

Typ: FiB

| Seite: 191

SCHMIDT VISBEK
Fenster, Türen, Innenelemente

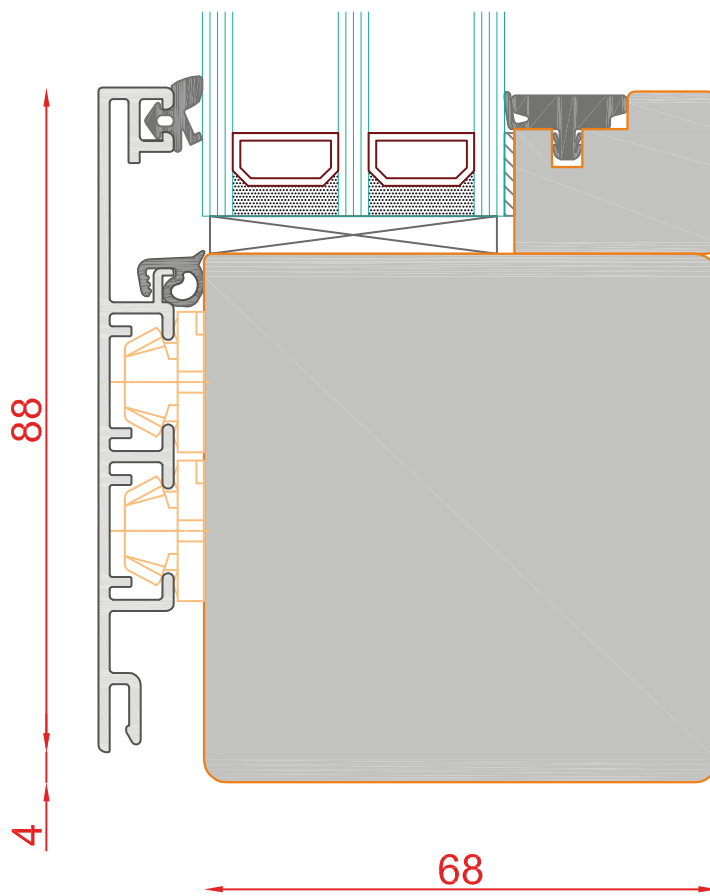
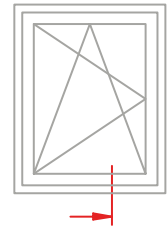

DUO 83
PLANO

Schnitt : Vertikal unten

Typ: FIB

192

SCHMIDT VISBEK
Fenster. Türen. Innovationen.

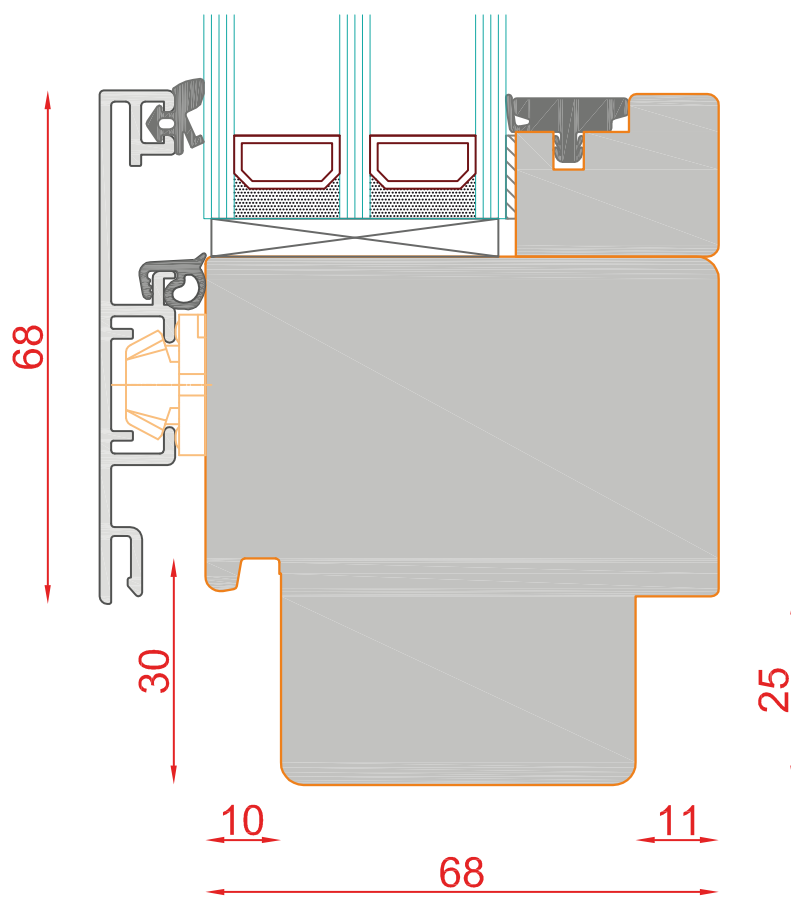
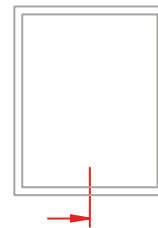

DUO 83
PLANO

Schnitt : Vertikal unten

Typ: FiB

193

SCHMIDT VISBEK
Fenster. Türen. Innovationen.

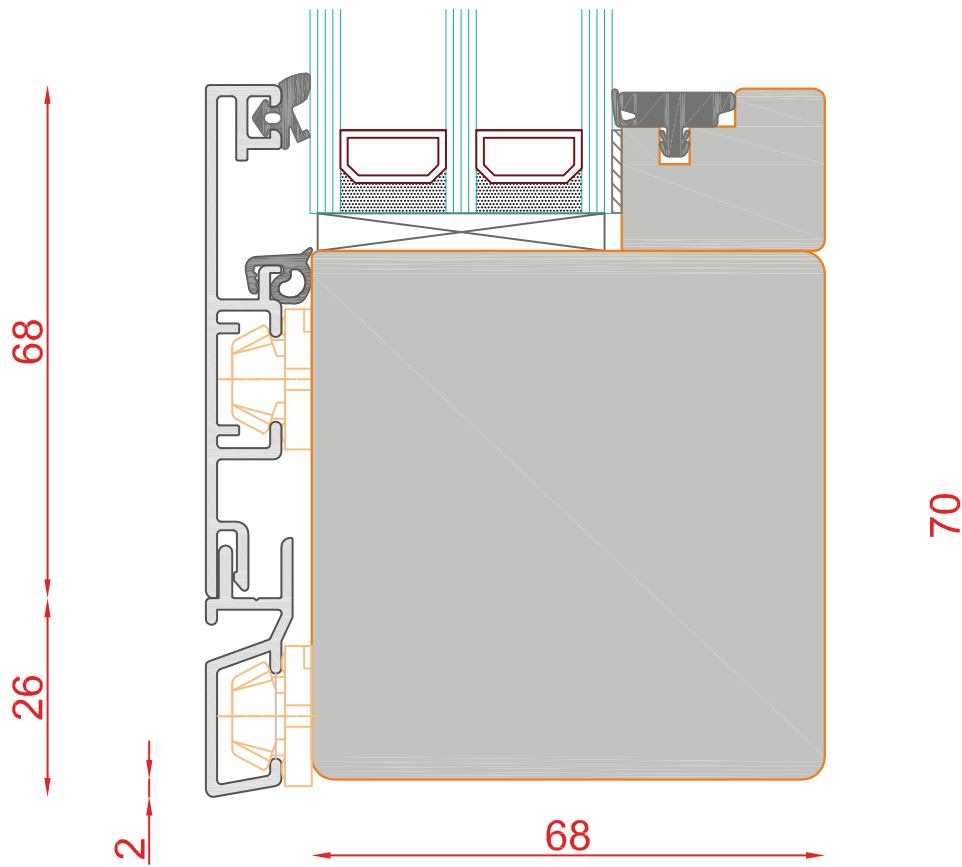
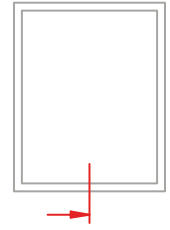

DUO 83
PLANO

Schnitt : Vertikal unten

Typ: FiB

| Seite: 194



SCHMIDT VISBEK
Fenster. Türen. Innovationen.

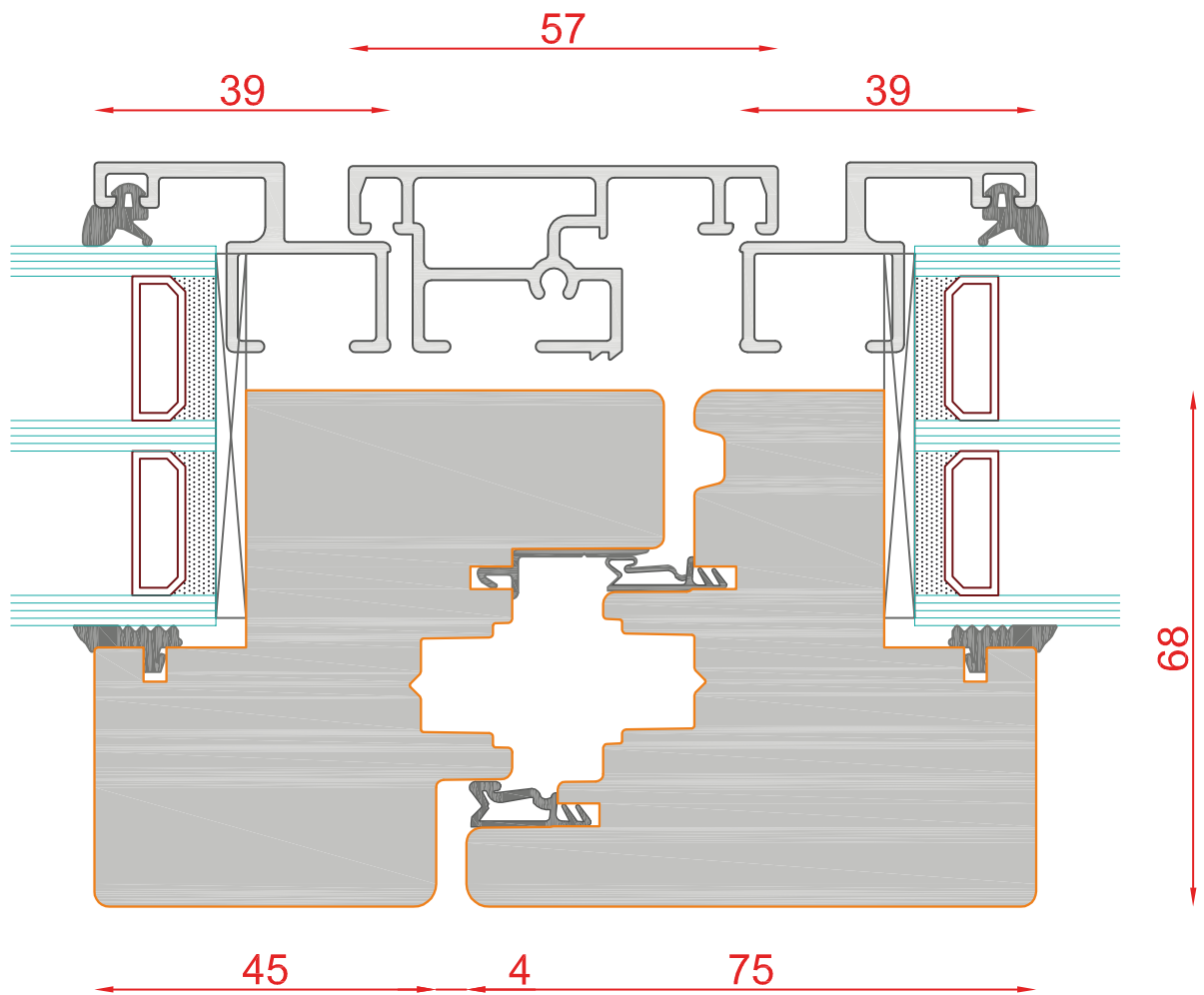
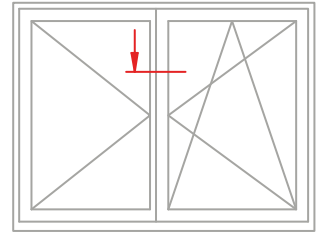

DUO 83
PLANO

Schnitt : Horizontal Stulp

Typ: DK

| Seite: 195

SCHMIDT VISBEK
Fenster. Türen. Innovationen.

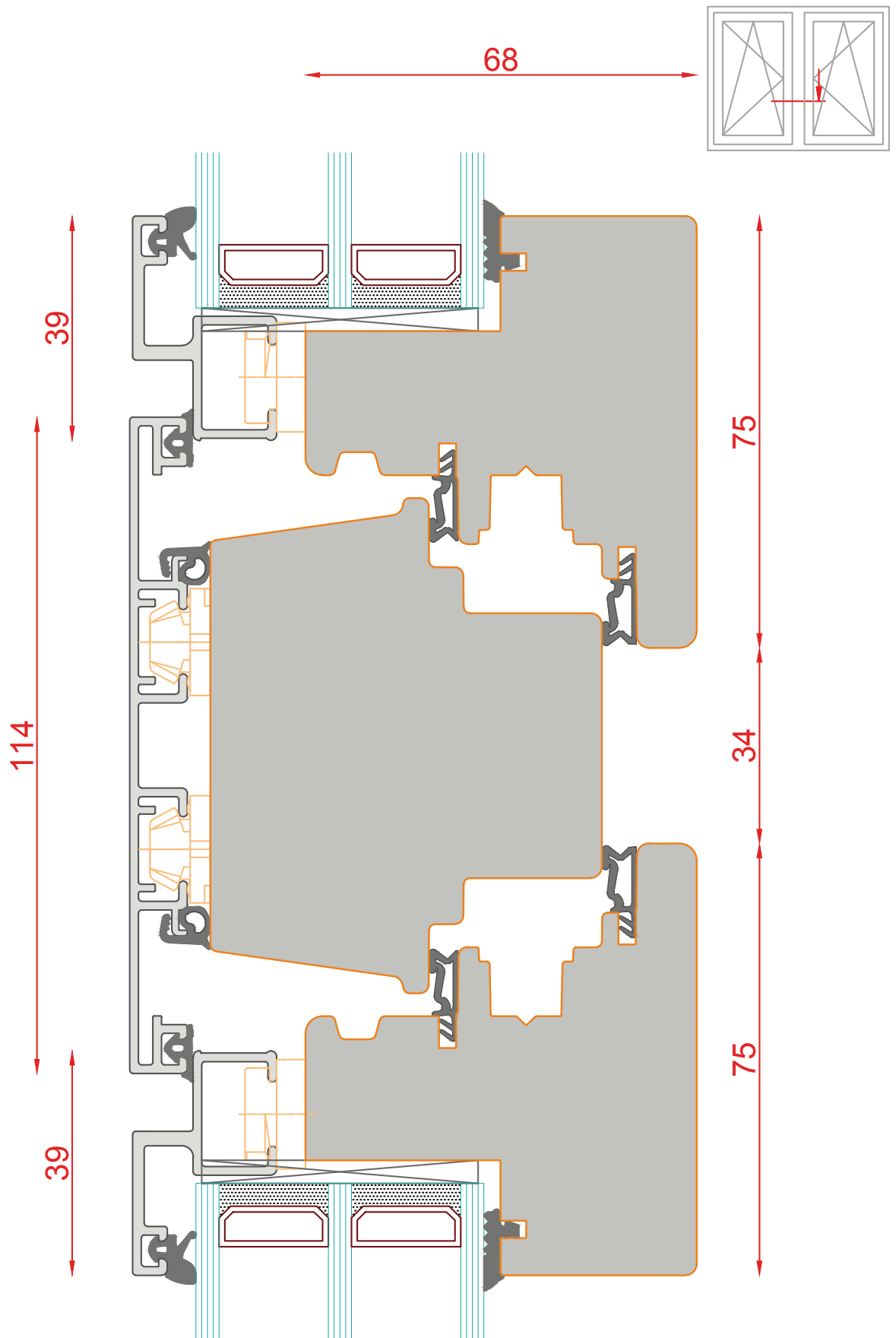

DUO 83
PLANO

Schnitt : Horizontal Mitte Pfosten

Typ: DK mit Mittelpfosten

| Seite: 196

SCHMIDT VISBEK
Fenster · Türen · Innenelemente



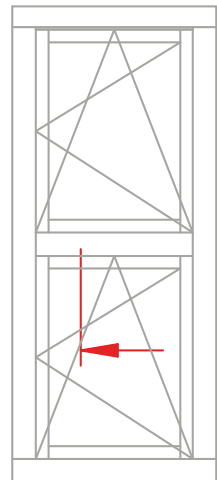
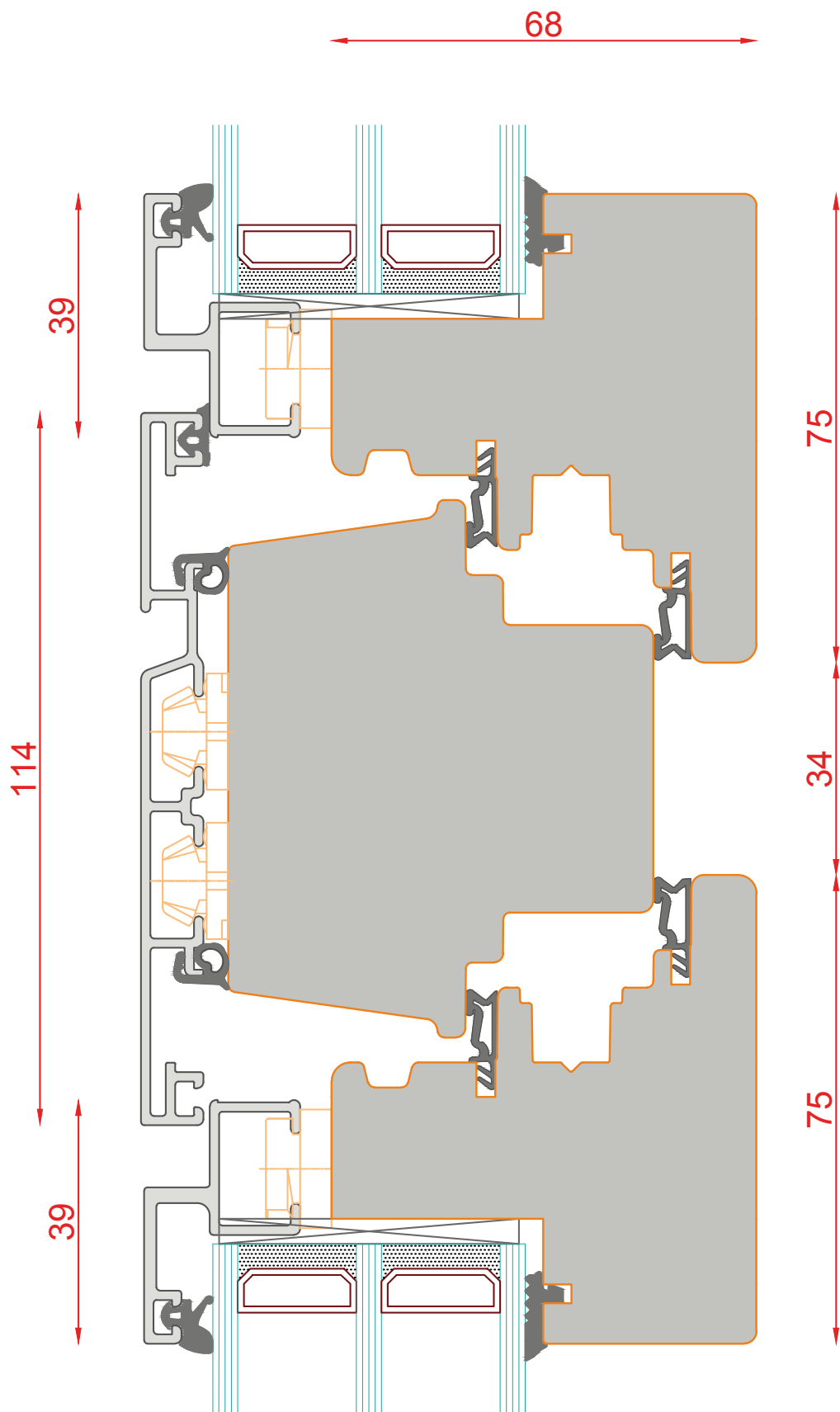

DUO 83
PLANO

Schnitt : Vertikal

Typ: Kämpfer DK - DK

| Seite: 197

SCHMIDT VISBEK

Fenster, Türen, Innenelemente.

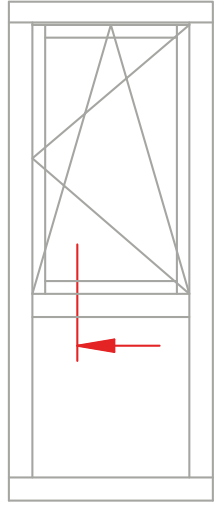
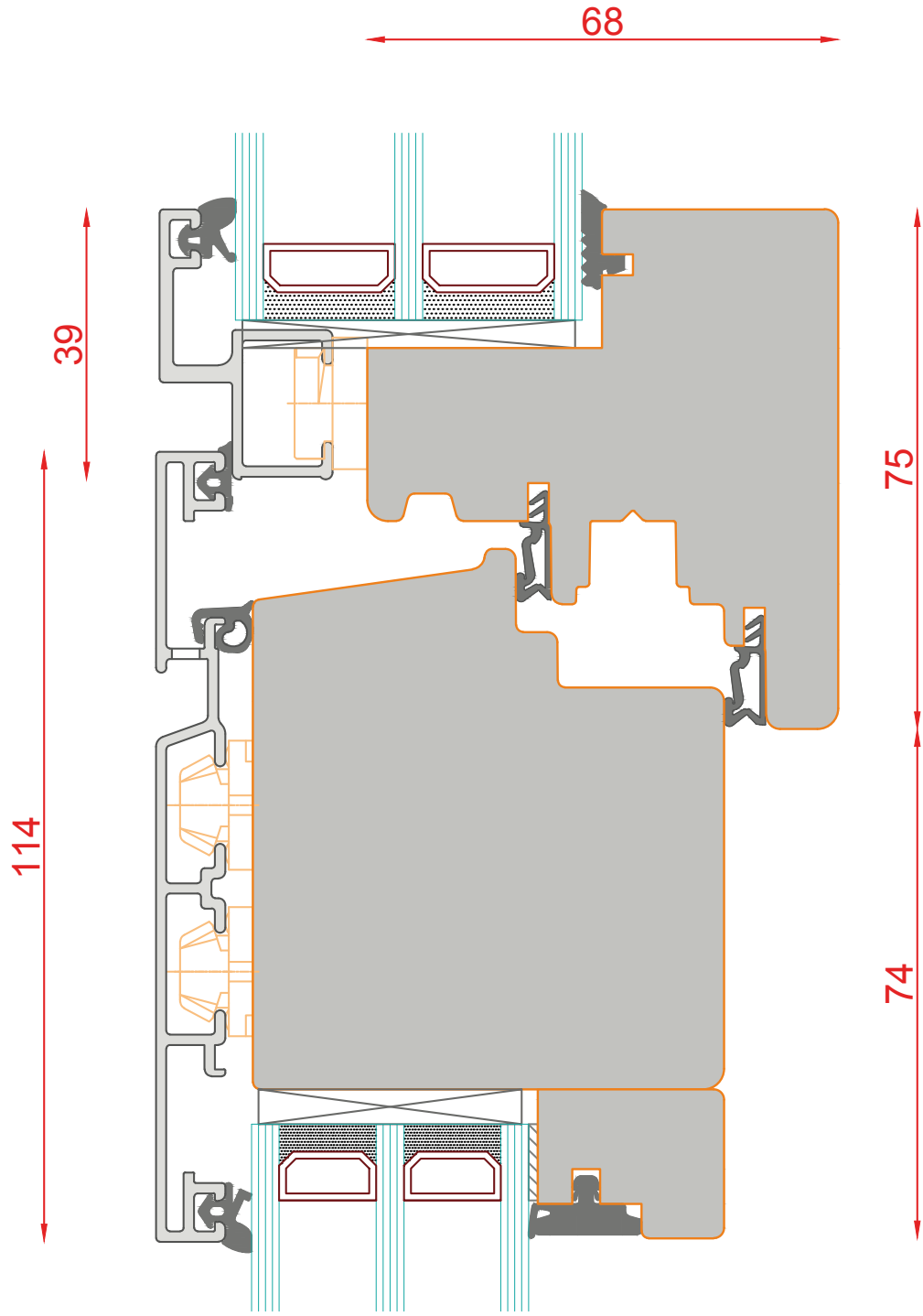

DUO 83
PLANO

Schnitt : Vertikal Kämpfer DK-FIB

Typ: FiB

| Seite: 198

SCHMIDT VISBEK

Fenster, Türen, Innenelemente.

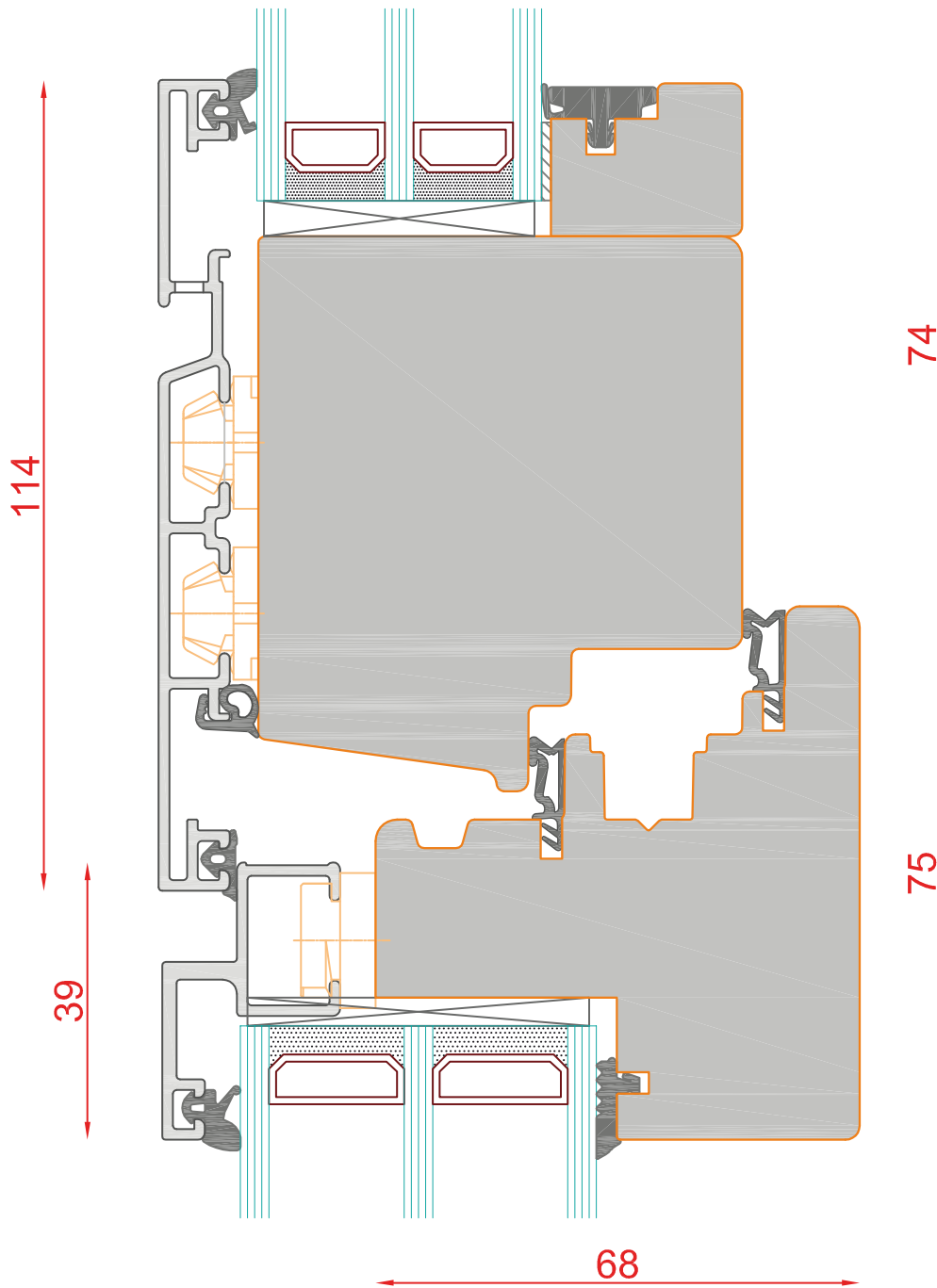
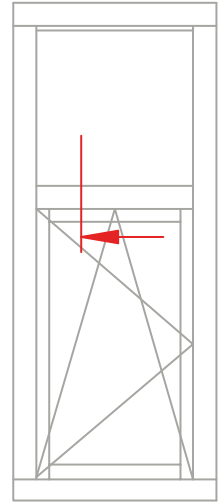

DUO 83
PLANO

Schnitt : Vertikal Kämpfer DK-FIB

Typ: FiB

| Seite: 199

SCHMIDT VISBEK
Fenster. Türen. Innovationen.

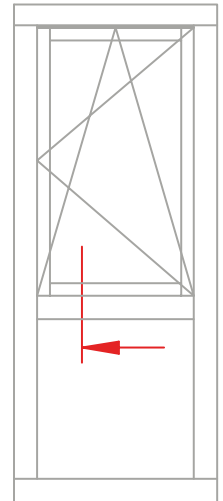
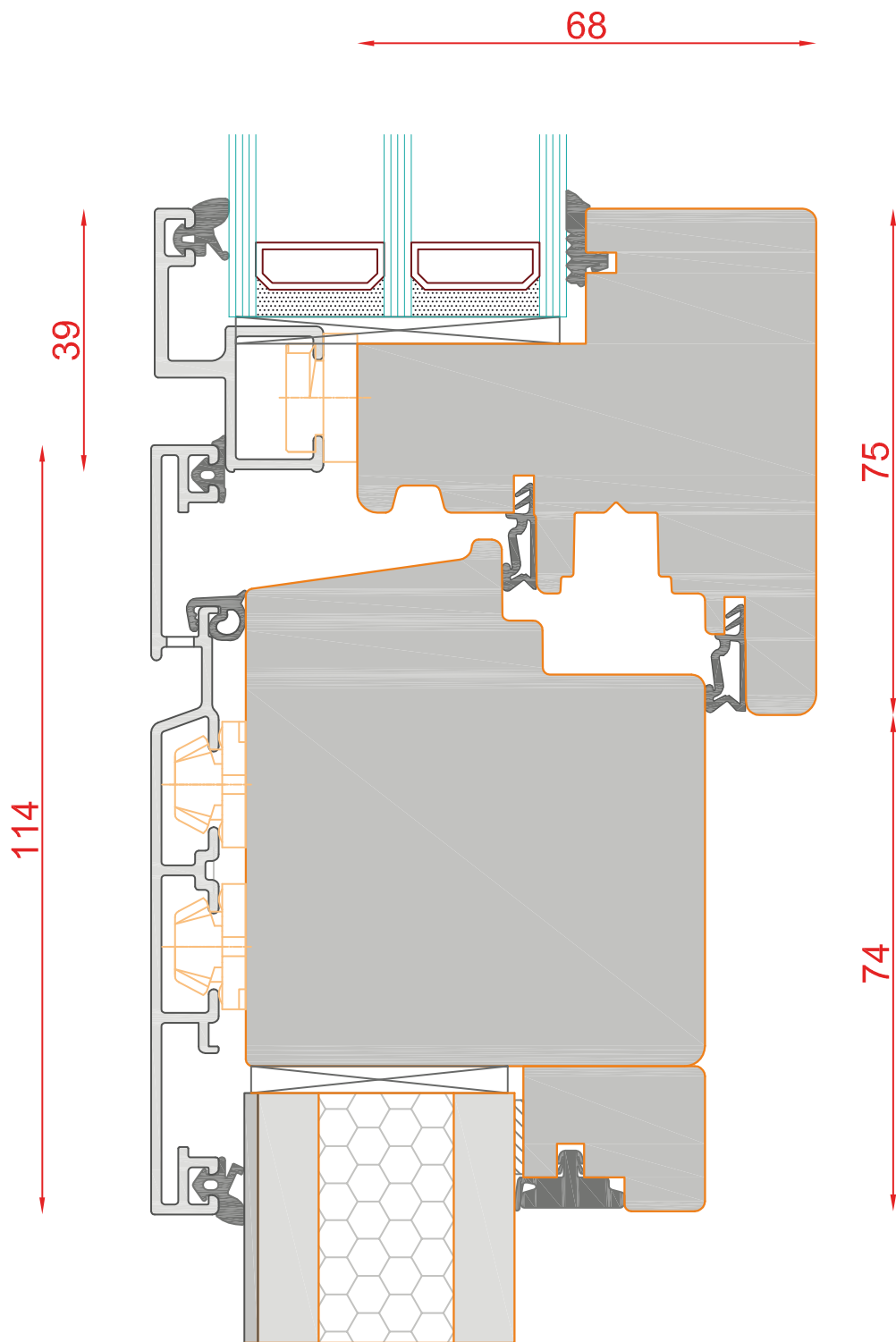

DUO 83
PLANO

Schnitt : Vertikal Kämpfer DK-FIB

Typ: Füllung

| Seite: 200

SCHMIDT VISBEK
Fenster. Türen. Innovationen.

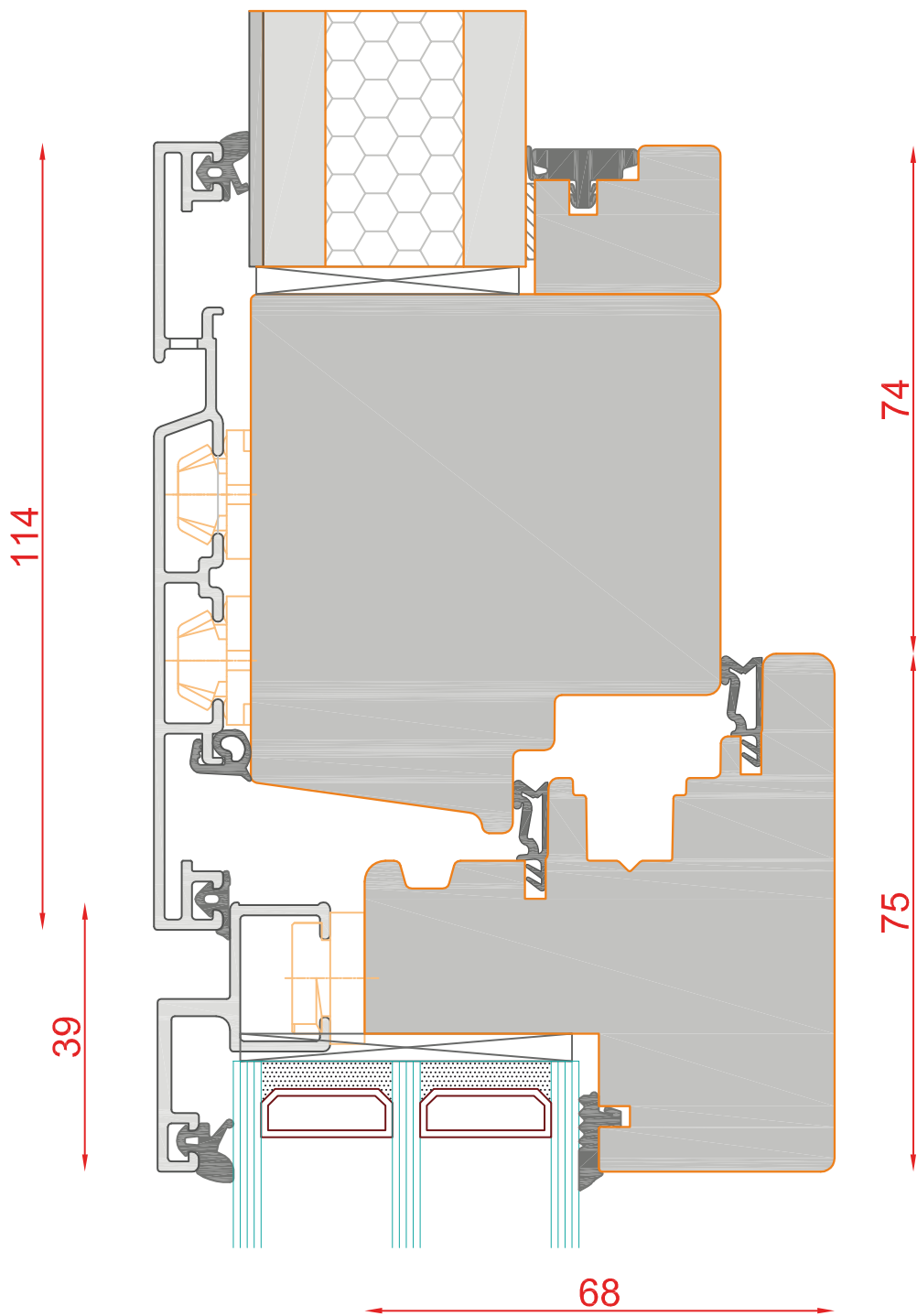
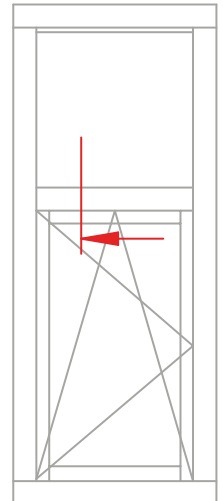

DUO 83
PLANO

Schnitt : Vertikal Kämpfer DK-FIB

Typ: Füllung

| Seite: 201

SCHMIDT VISBEK
Fenster. Türen. Innovationen.

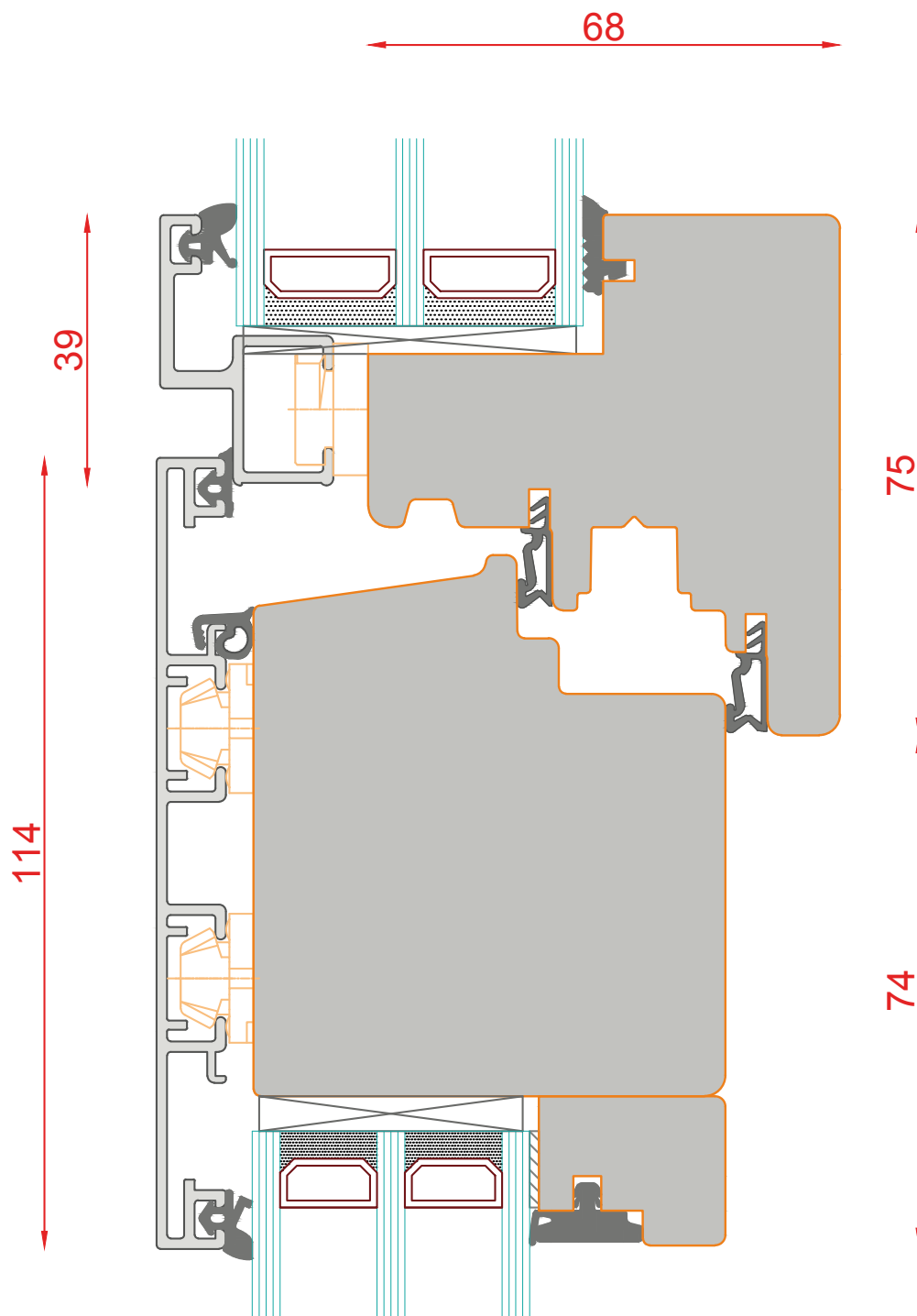
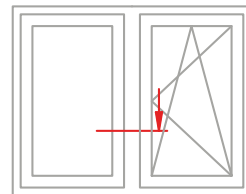

DUO 83
PLANO

Schnitt : Horizontal Mitte

Typ: DK - FIB

| Seite: 202

SCHMIDT VISBEK
Fenster. Türen. Innenelemente.

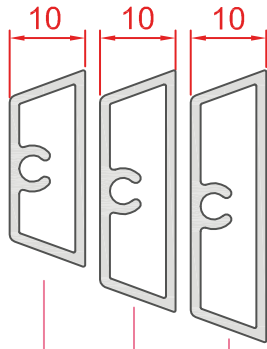

SP 36.10 = 36mm
 SP 32.10 = 32mm
 SP 26.10 = 26mm

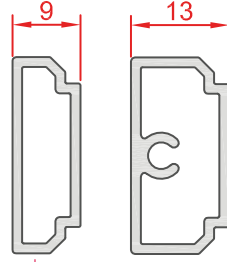

SP 26.13-SK = 26mm
 SP 26.9-SK = 26mm

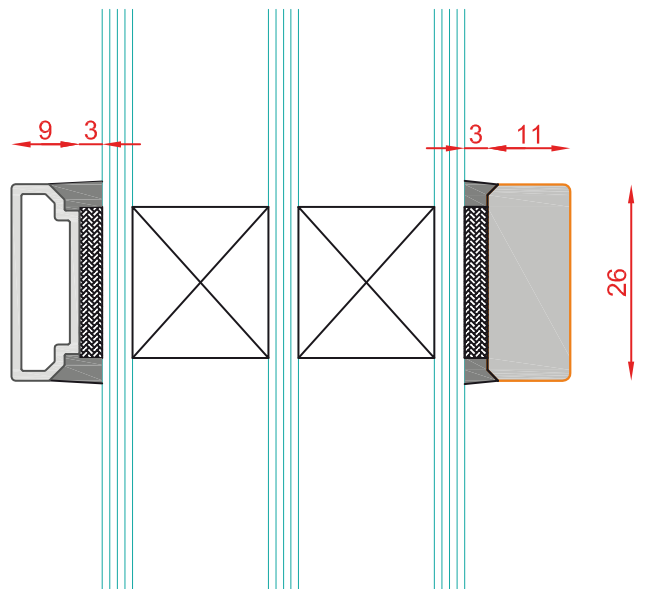
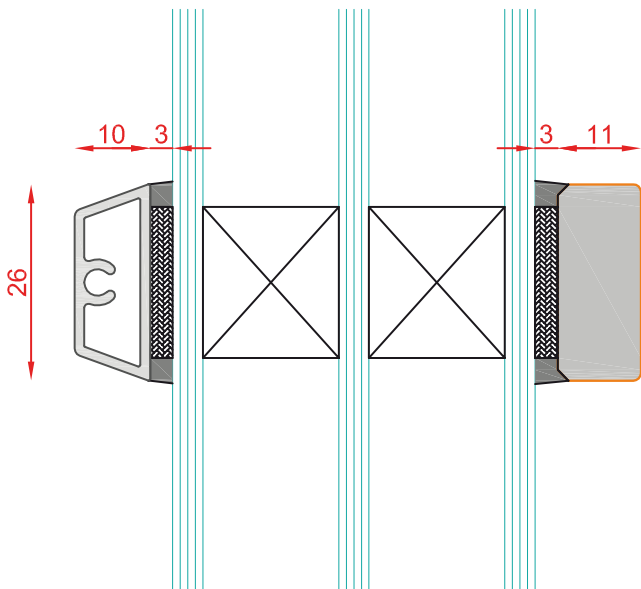
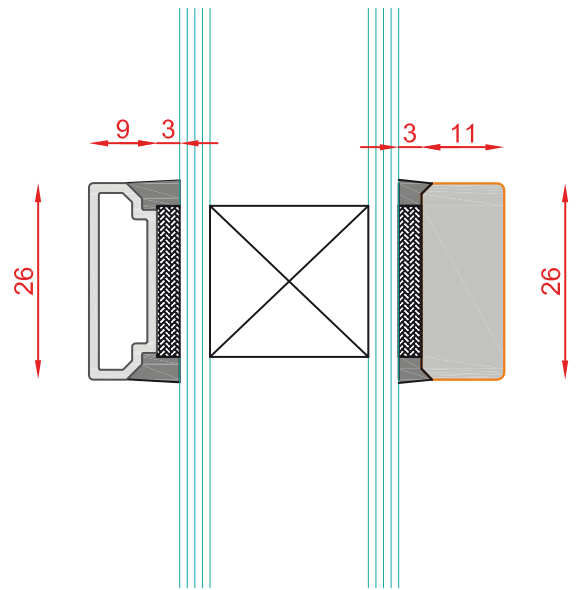
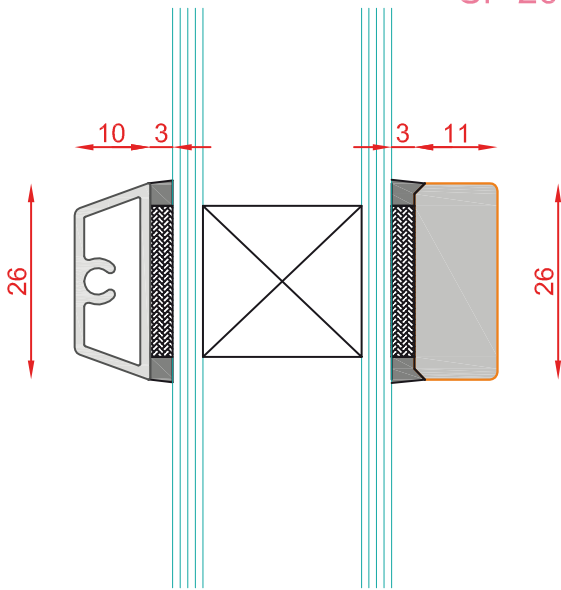

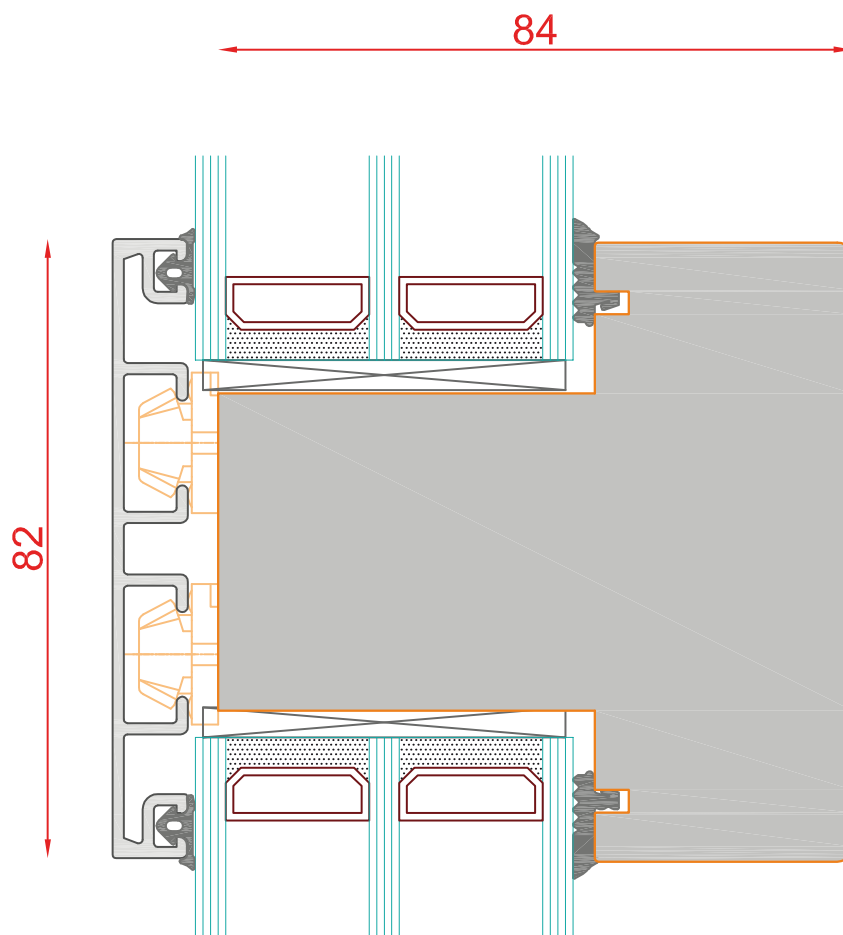
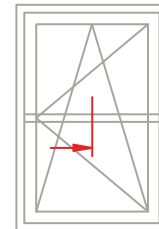

DUO 83
PLANO

Schnitt : Sprosse Glasteilend

Typ: Flügel

| Seite: 204

SCHMIDT VISBEK
Fenster. Türen. Innovationen.

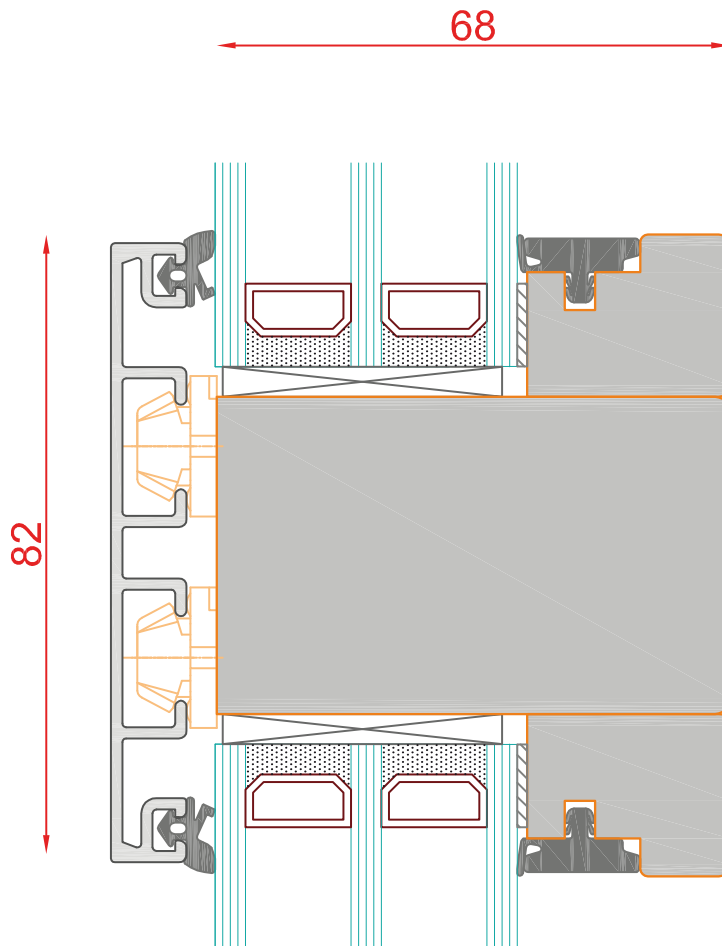
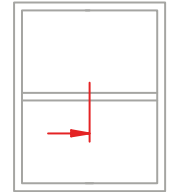

DUO 83
PLANO

Schnitt : Sprosse Glasteilend

Typ: Blendrahmen

| Seite: 205

SCHMIDT VISBEK
Fenster. Türen. Innovationen.

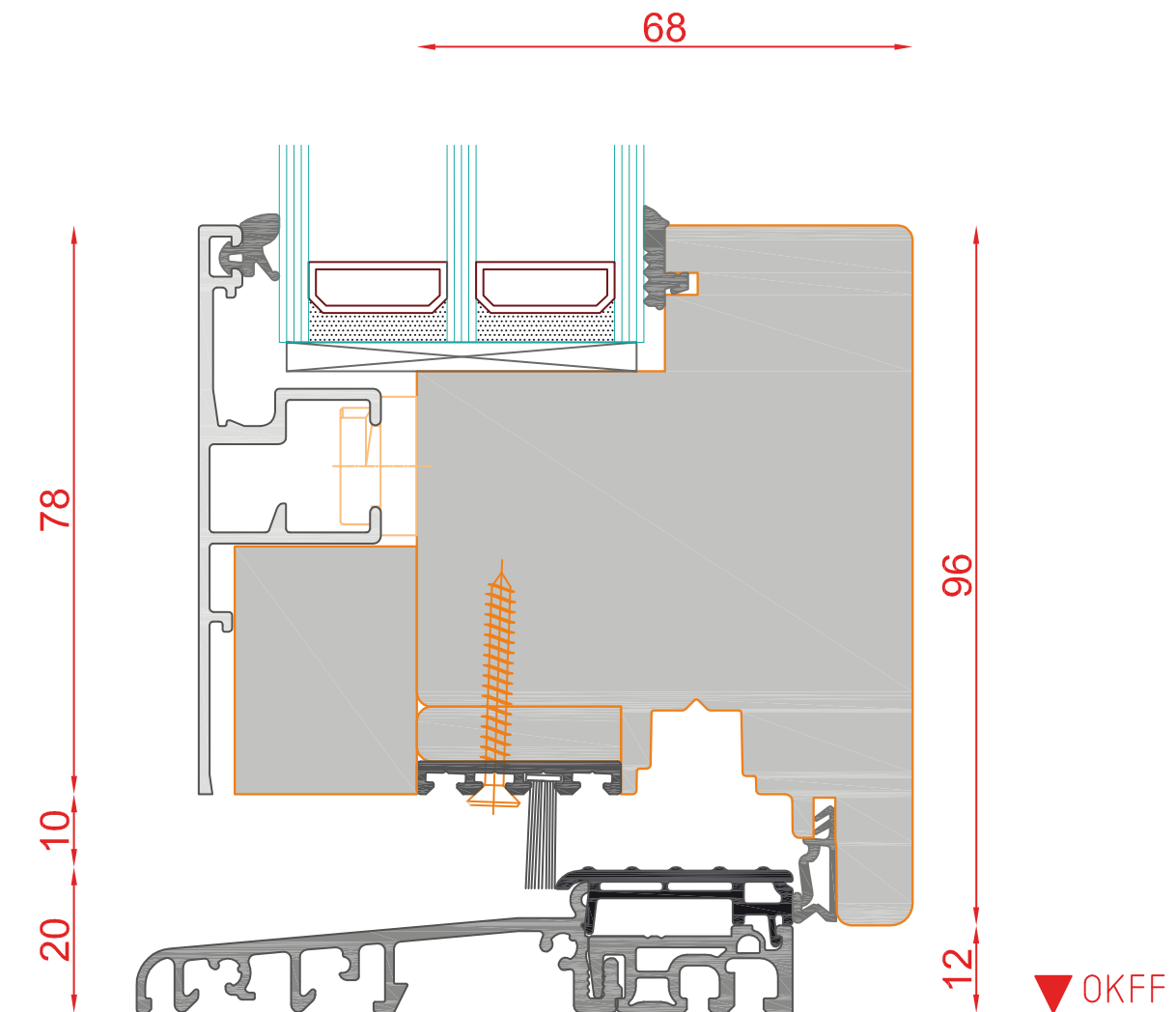
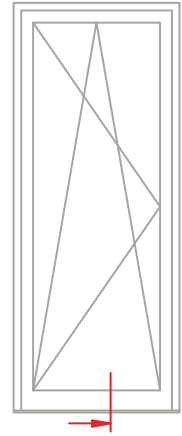

Bodenschwelle BKV Eifel 90 TB



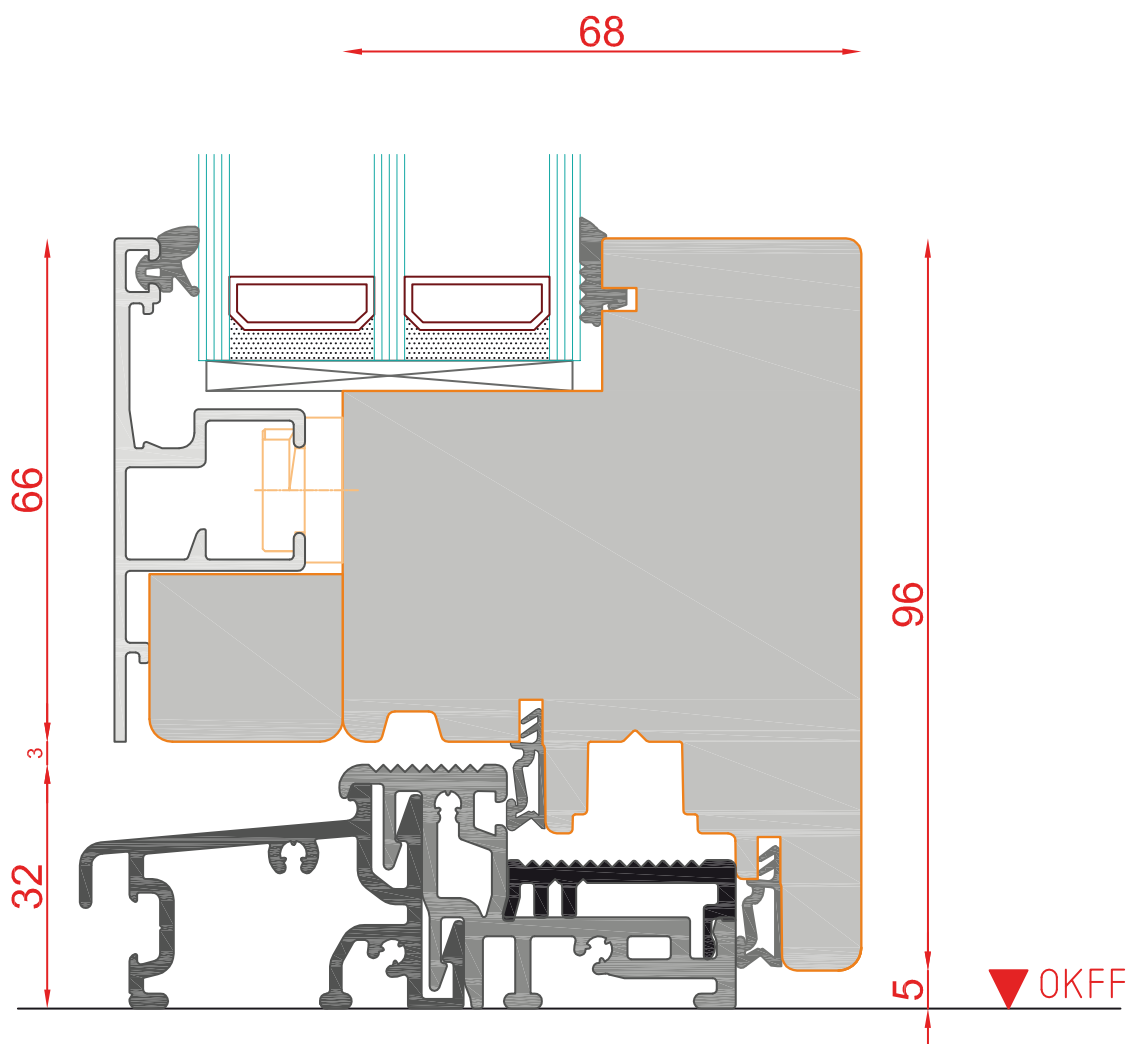
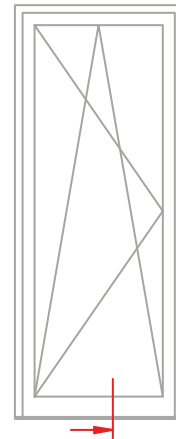

Bodenschwelle Weser 86/32 Ti



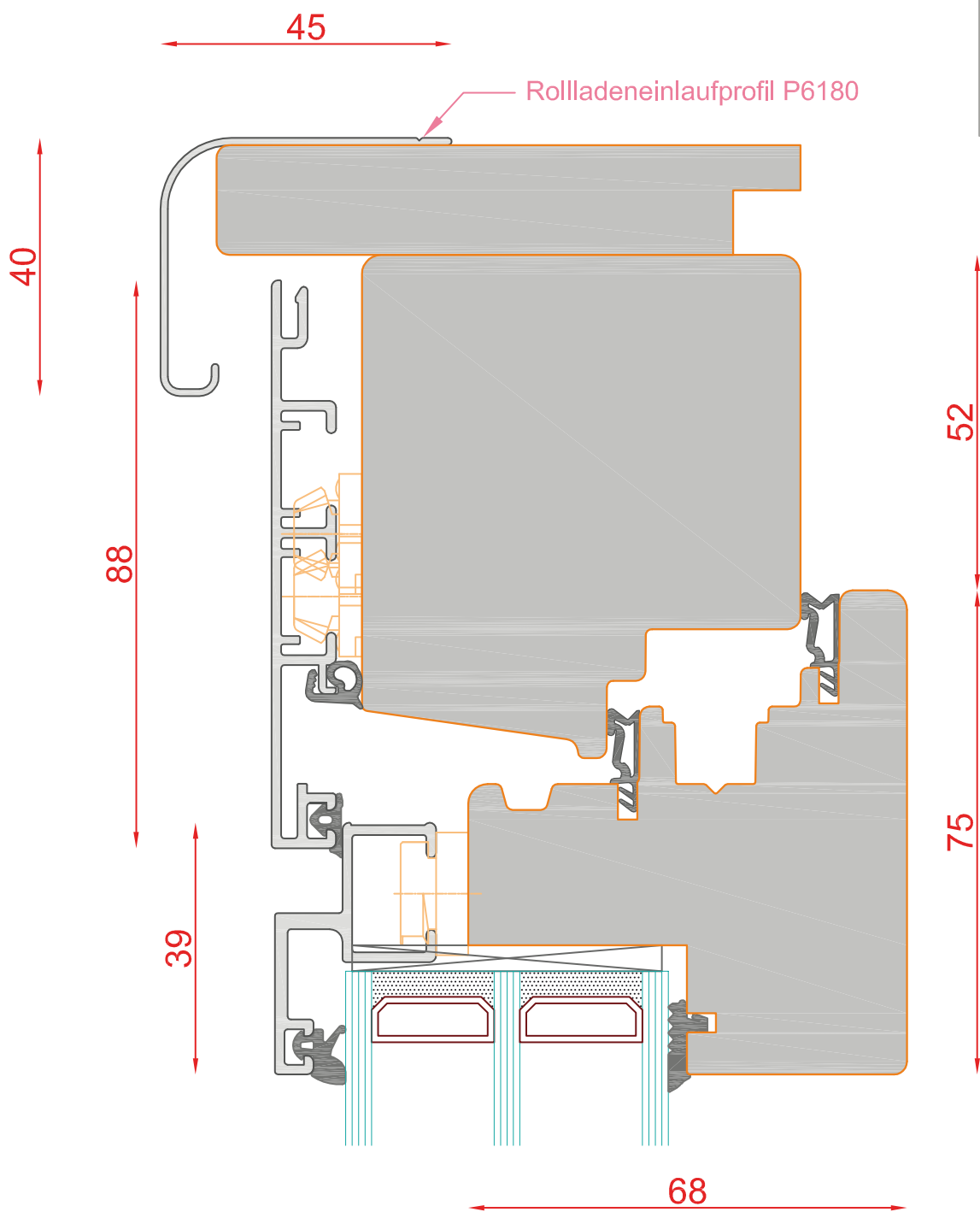
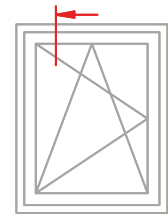

DUO 83
PLANO

Schnitt : Horizontal seitlich und oben

Typ: DK

| Seite: 208

SCHMIDT VISBEK
Fenster. Türen. Innovationen.



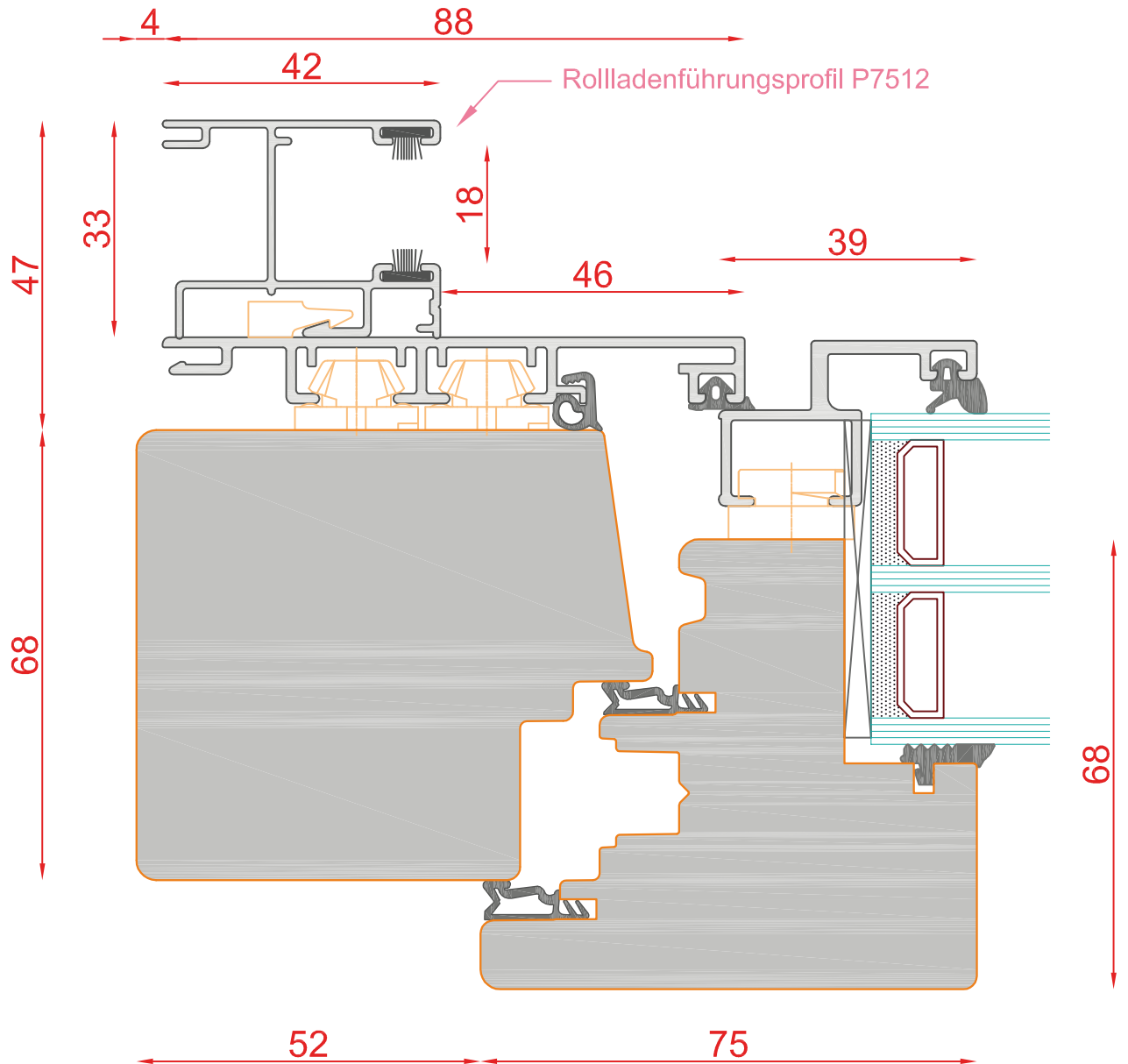
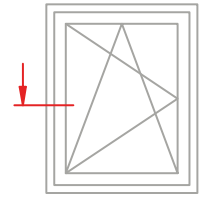

DUO 83
PLANO

Schnitt : Horizontal seitlich und oben

Typ: DK

| Seite: 209

SCHMIDT VISBEK
Fenster. Türen. Innovationen.

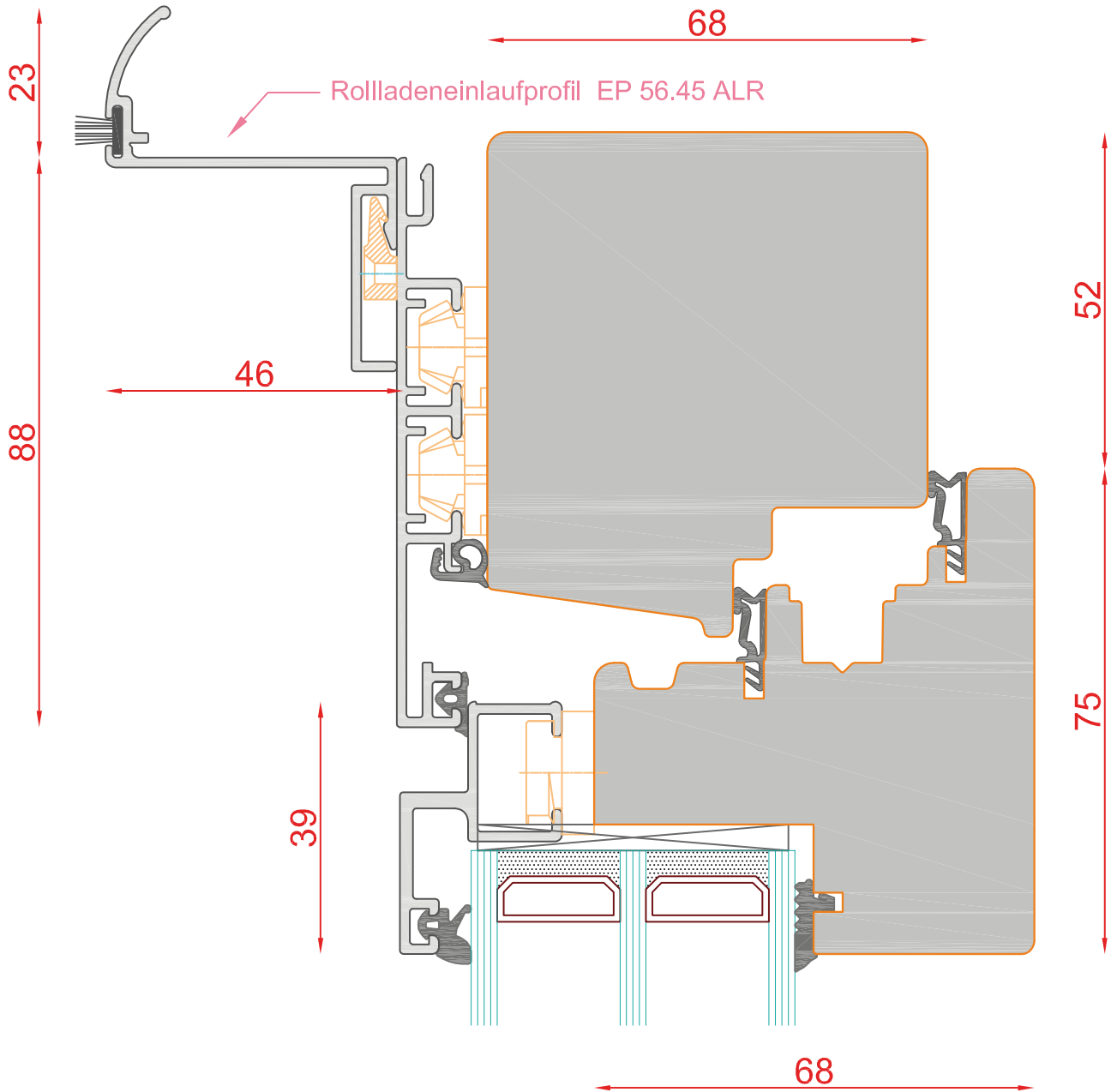
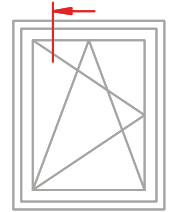

DUO 83
PLANO

Schnitt : Horizontal seitlich und oben

Typ: DK

| Seite: 210

SCHMIDT VISBEK
Fenster. Türen. Innovationen.

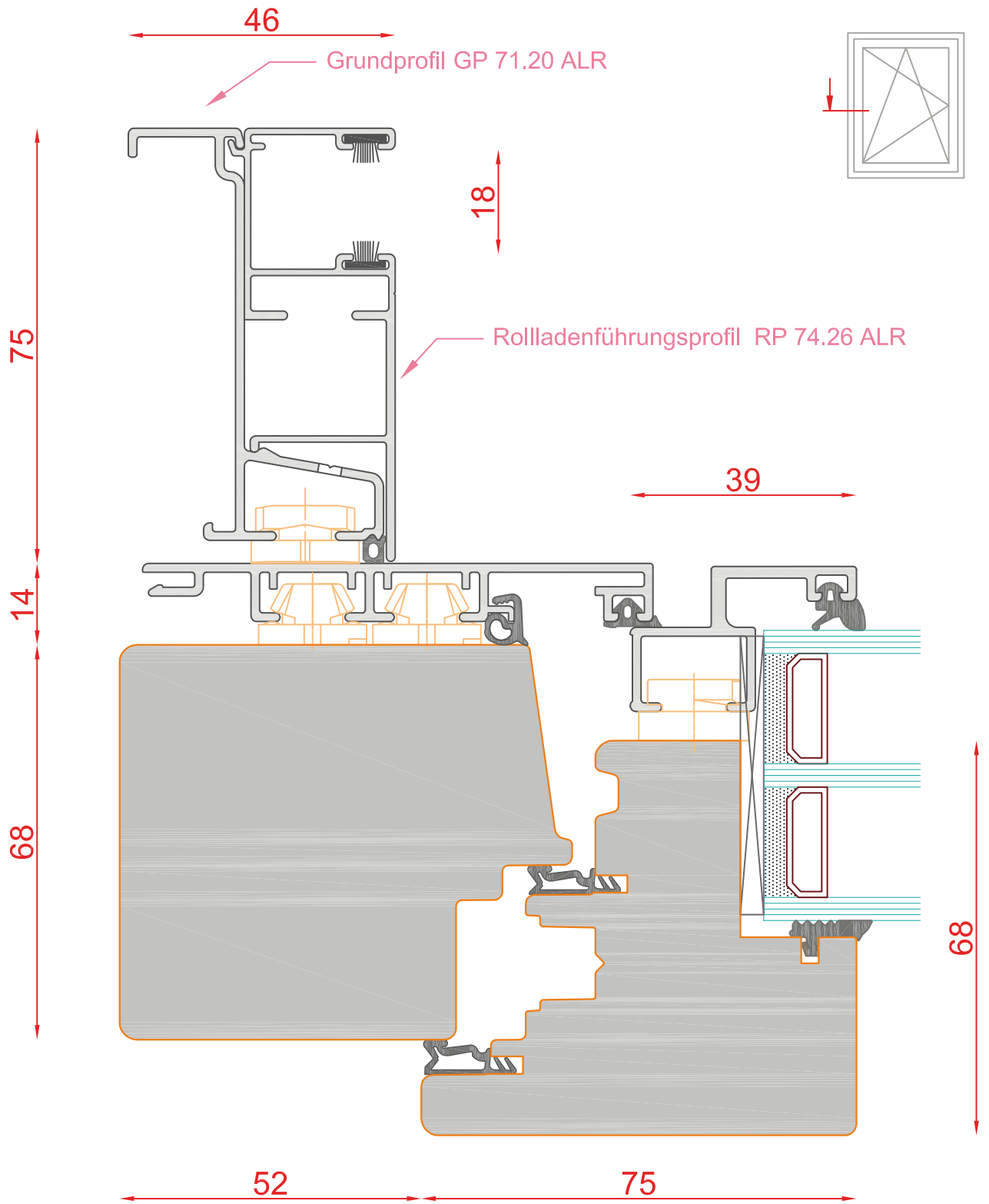

DUO 100

Plano

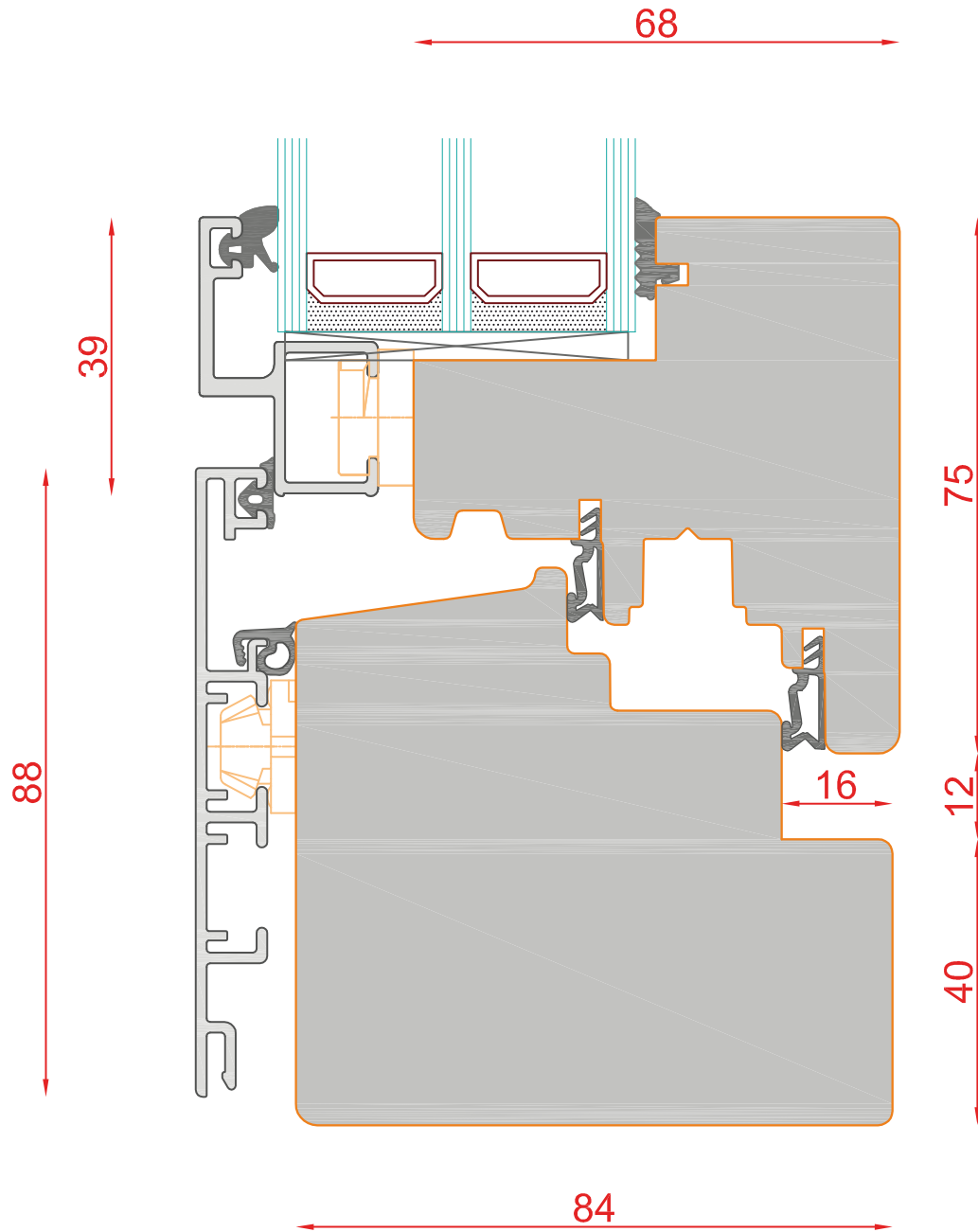
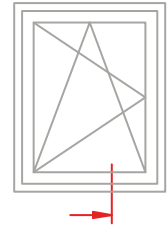

DUO 100
PLANO

Schnitt : Vertikal unten

Typ: DK

| Seite: 213

SCHMIDT VISBEK
Fenster. Türen. Innovationen.

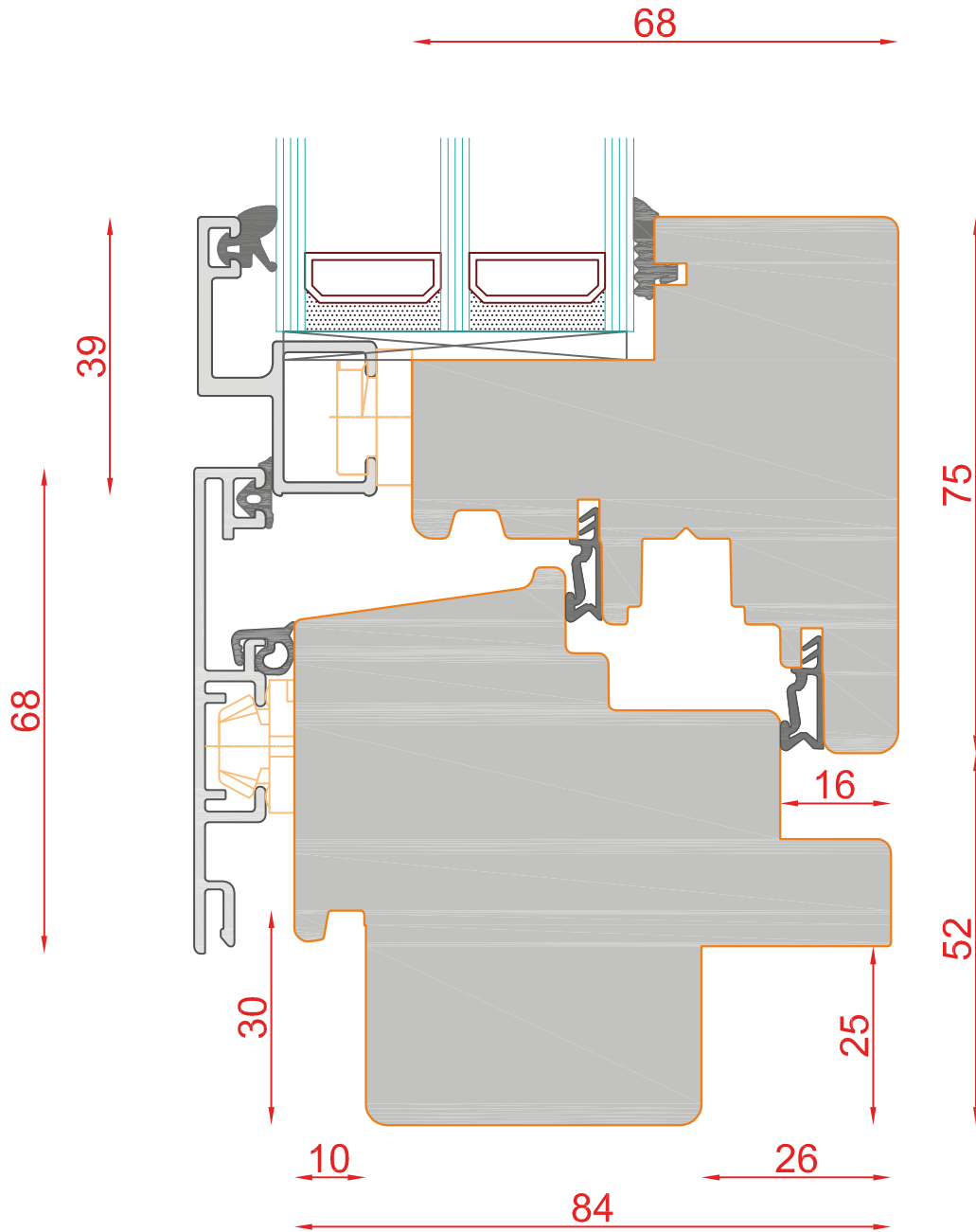
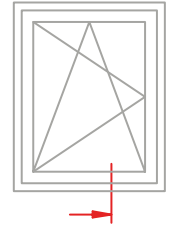

DUO 100
PLANO

Schnitt : Vertikal unten

Typ: DK mit Fensterbankfalz | Seite: 214

SCHMIDT VISBEK
Fenster. Türen. Innovationen.

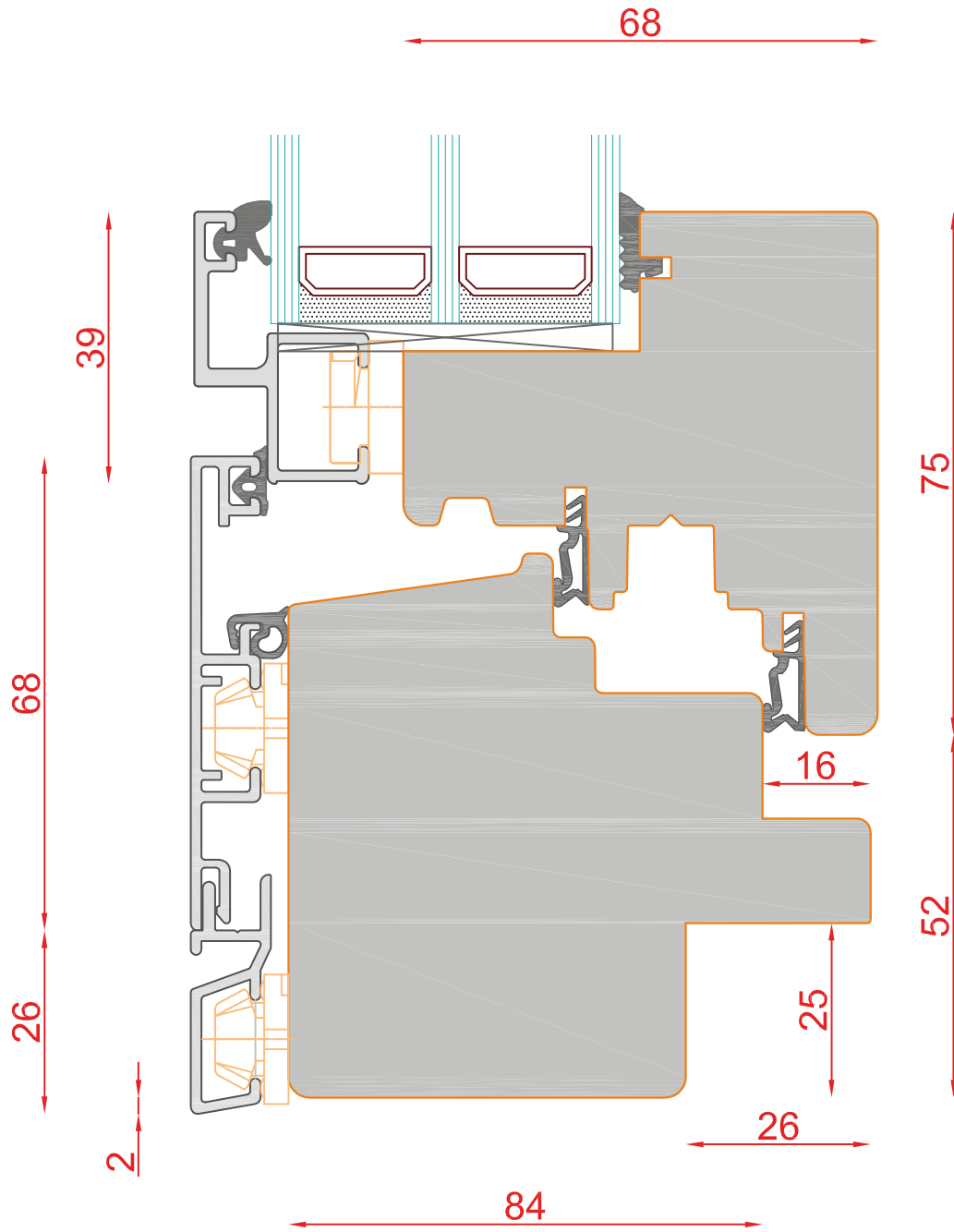
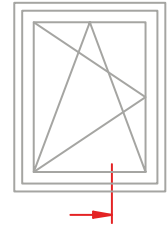

DUO 100
PLANO

Schnitt : Vertikal unten

Typ: DK mit Steinbankanschluss | Seite: 215



SCHMIDT VISBEK
Fenster. Türen. Innovationen.

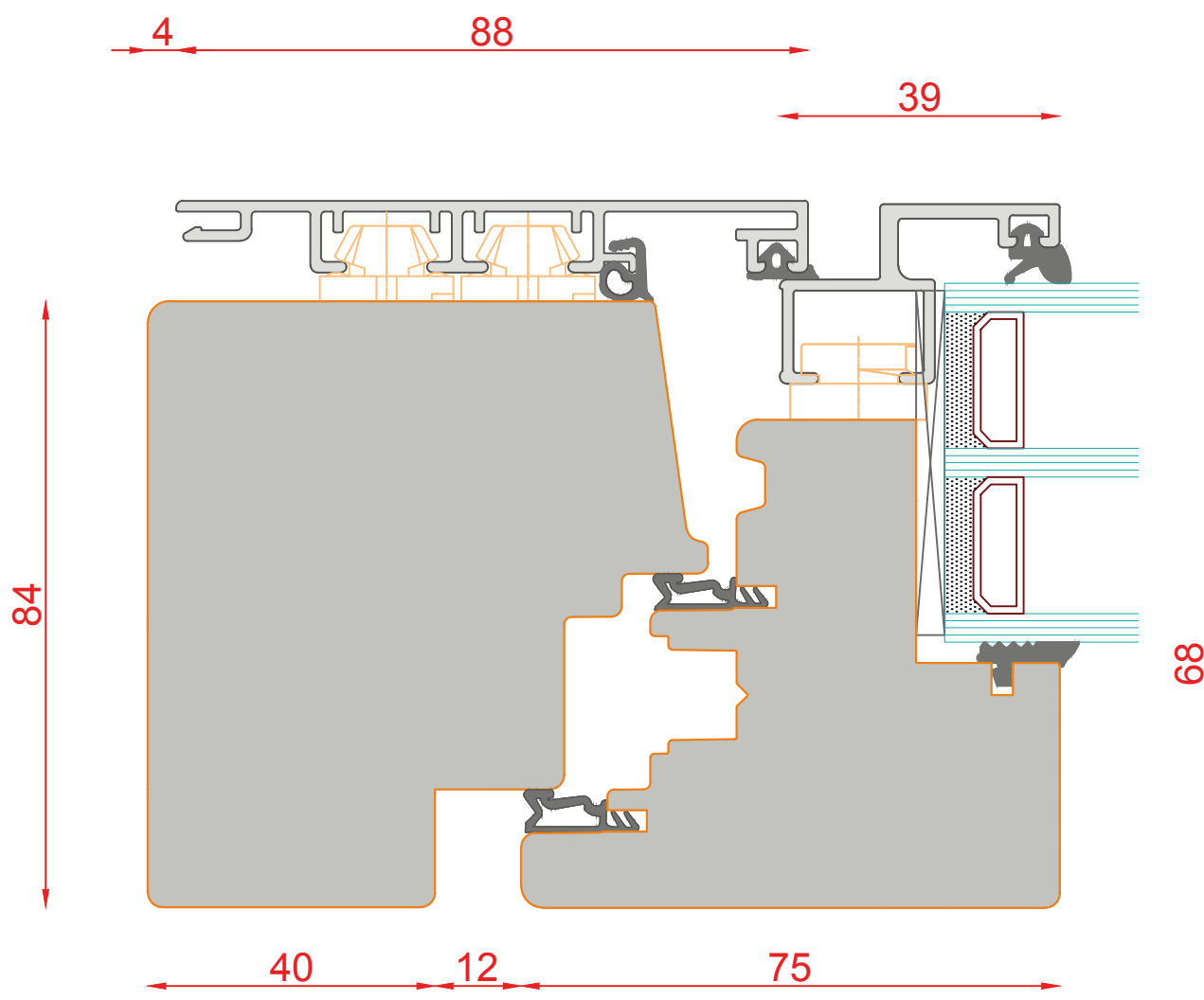
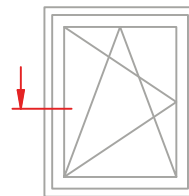

DUO 100
PLANO

Schnitt : Horizontal seitlich und oben

Typ: DK

| Seite: 216

SCHMIDT VISBEK
Fenster Türen Innenelemente

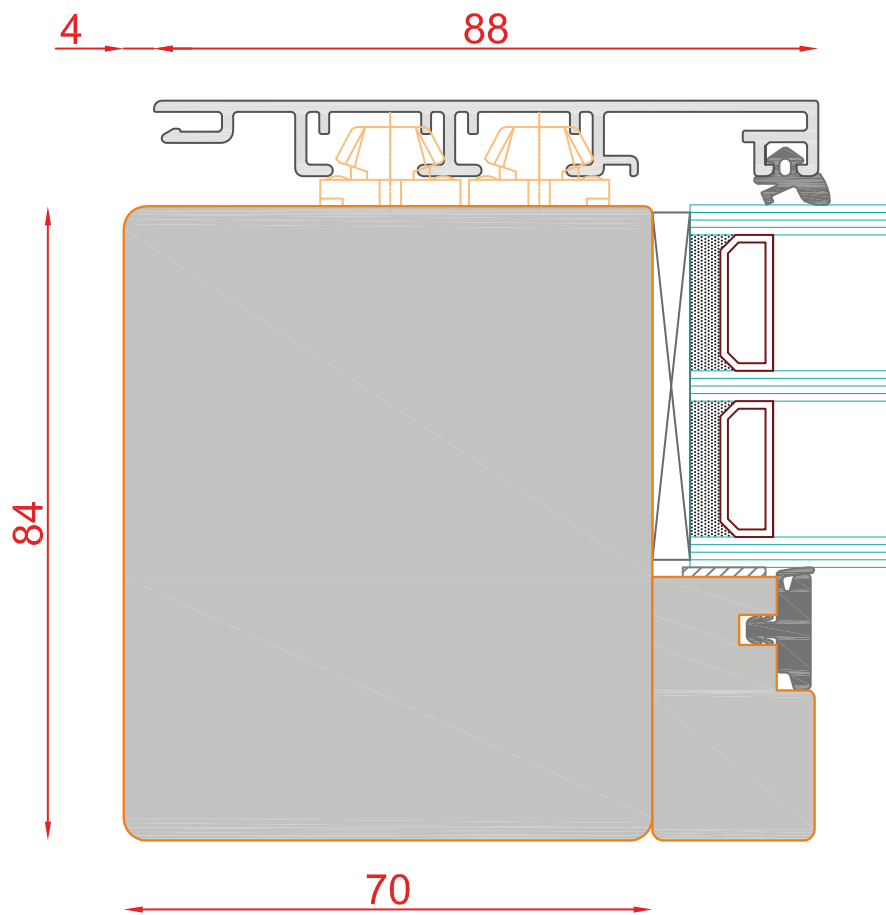
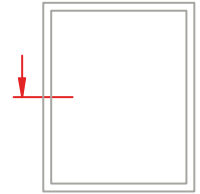

DUO 100
PLANO

Schnitt : Horizontal seitlich und oben

Typ: FiB

| Seite: 217

SCHMIDT VISBEK
Fenster. Türen. Innovationen.

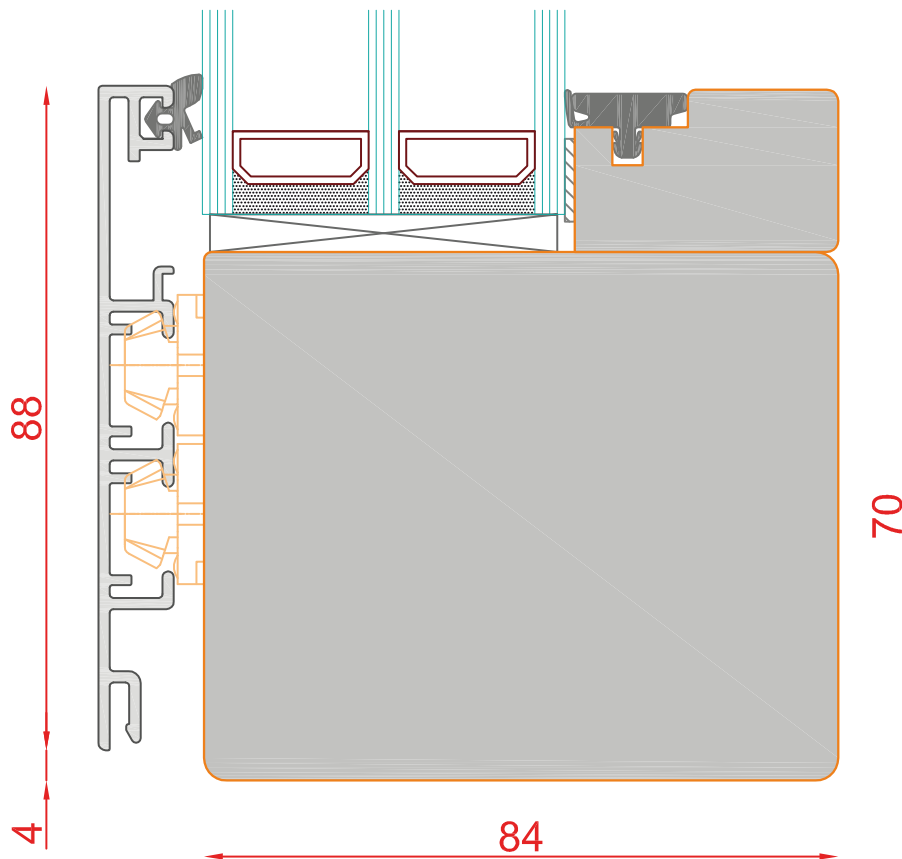
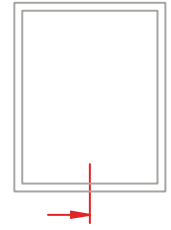

DUO 100
PLANO

Schnitt : Vertikal unten

Typ: FIB

| Seite: 218

SCHMIDT VISBEK
Fenster. Türen. Innovationen.



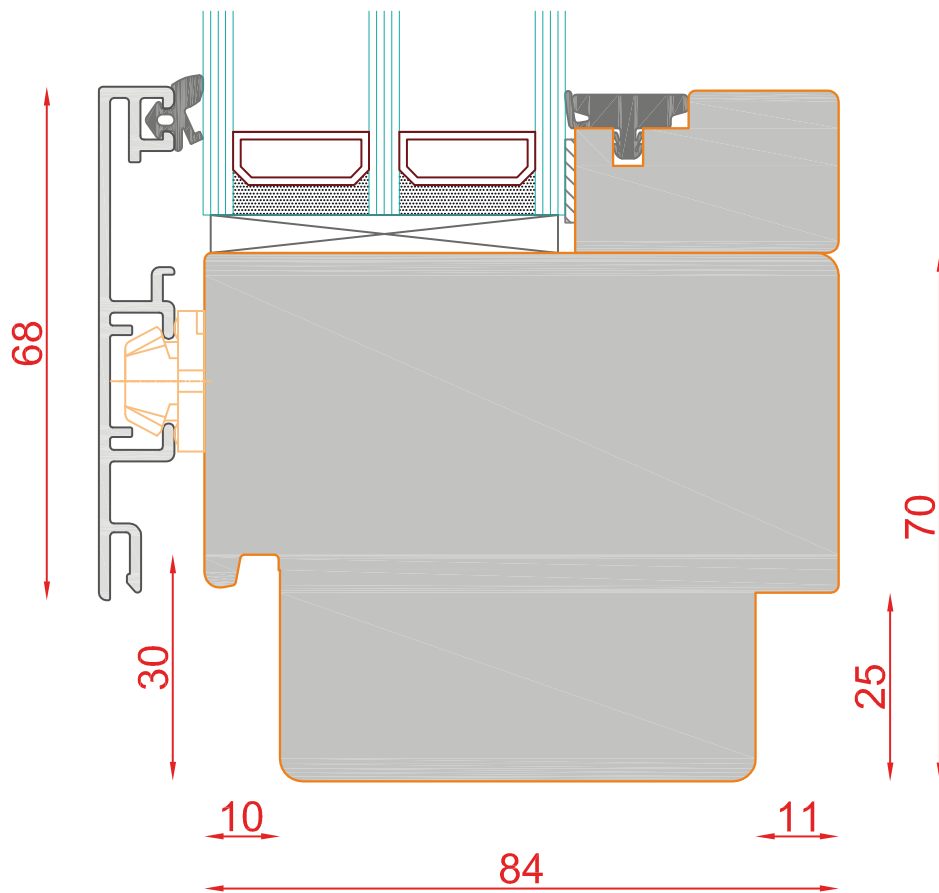
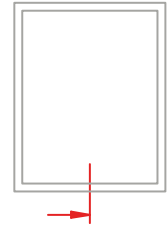

DUO 100
PLANO

Schnitt : Vertikal unten

Typ: FiB

| Seite: 219

SCHMIDT VISBEK
Fenster. Türen. Innovationen.

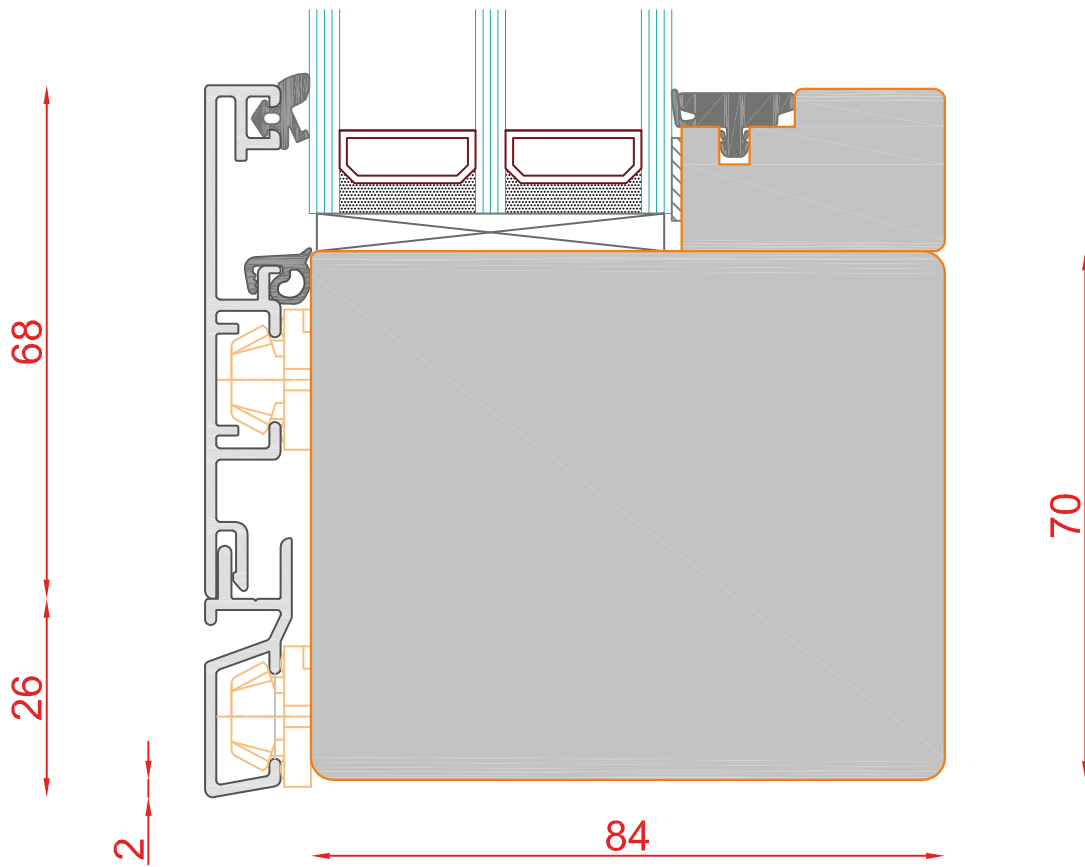
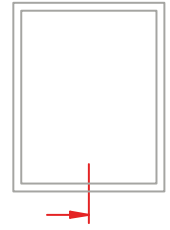

DUO 100
PLANO

Schnitt : Vertikal unten

Typ: FiB

| Seite: 220

SCHMIDT VISBEK
Fenster. Türen. Innovationen.

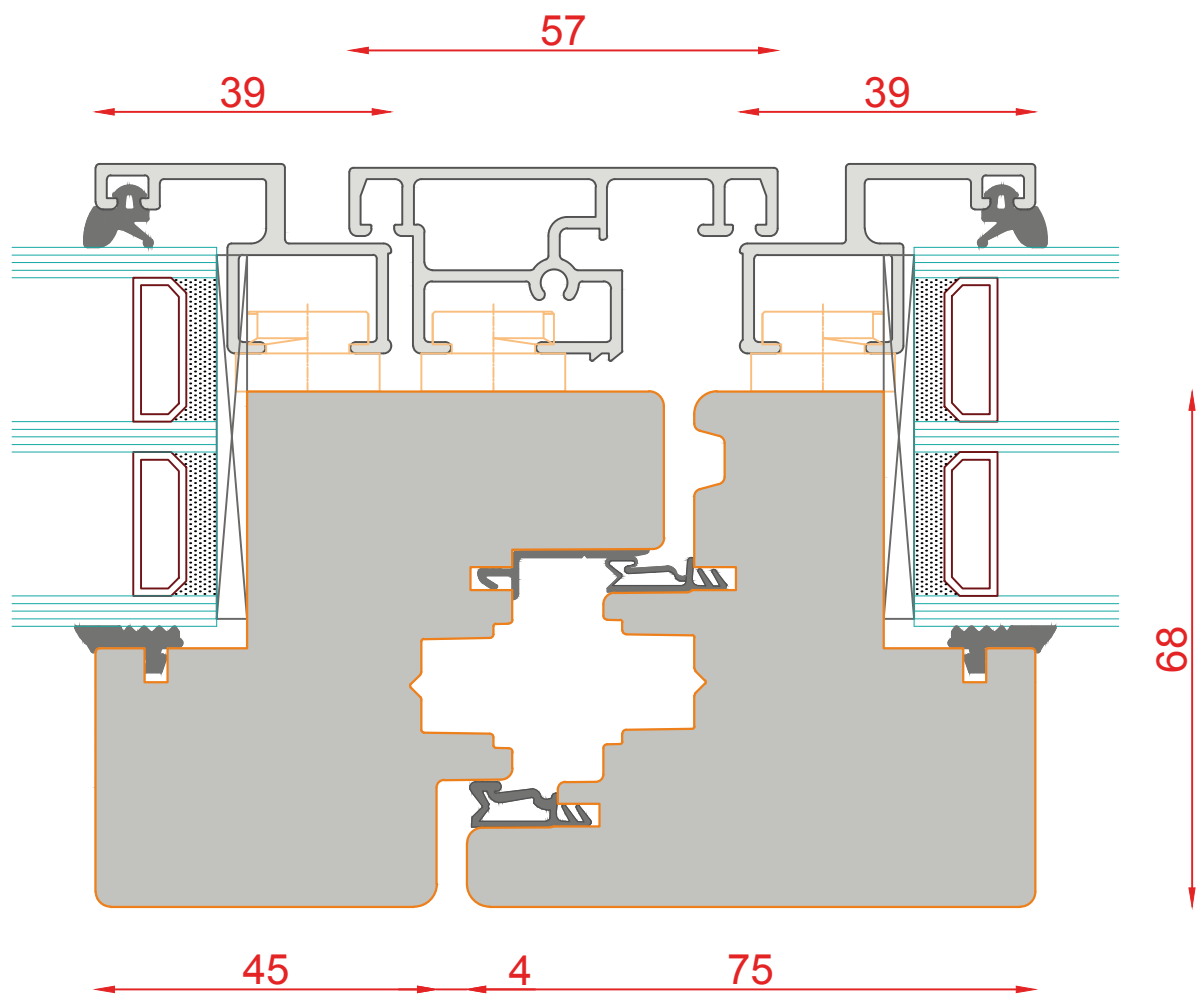
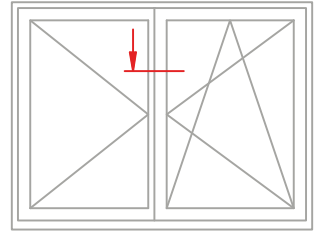

DUO 100
PLANO

Schnitt : Horizontal Stulp

Typ: DK

| Seite: 221

SCHMIDT VISBEK
Fenster Türen Innentüren

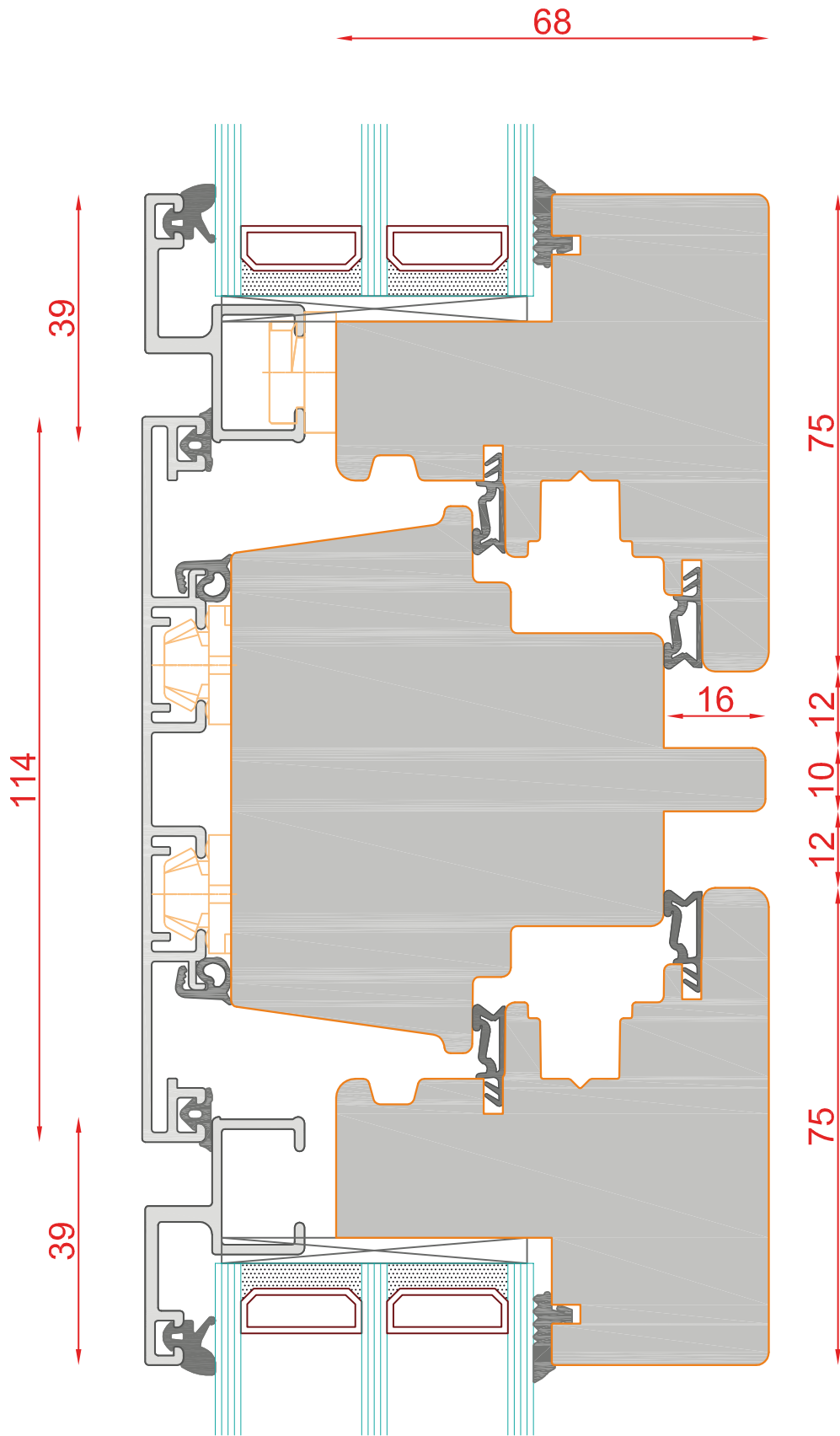

DUO 100
PLANO

Schnitt : Horizontal Mitte Pfosten

Typ: DK mit Mittelpfosten

| Seite: 222

SCHMIDT VISBEK
Fenster. Türen. Innovationen.



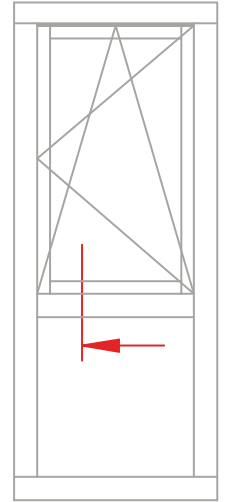
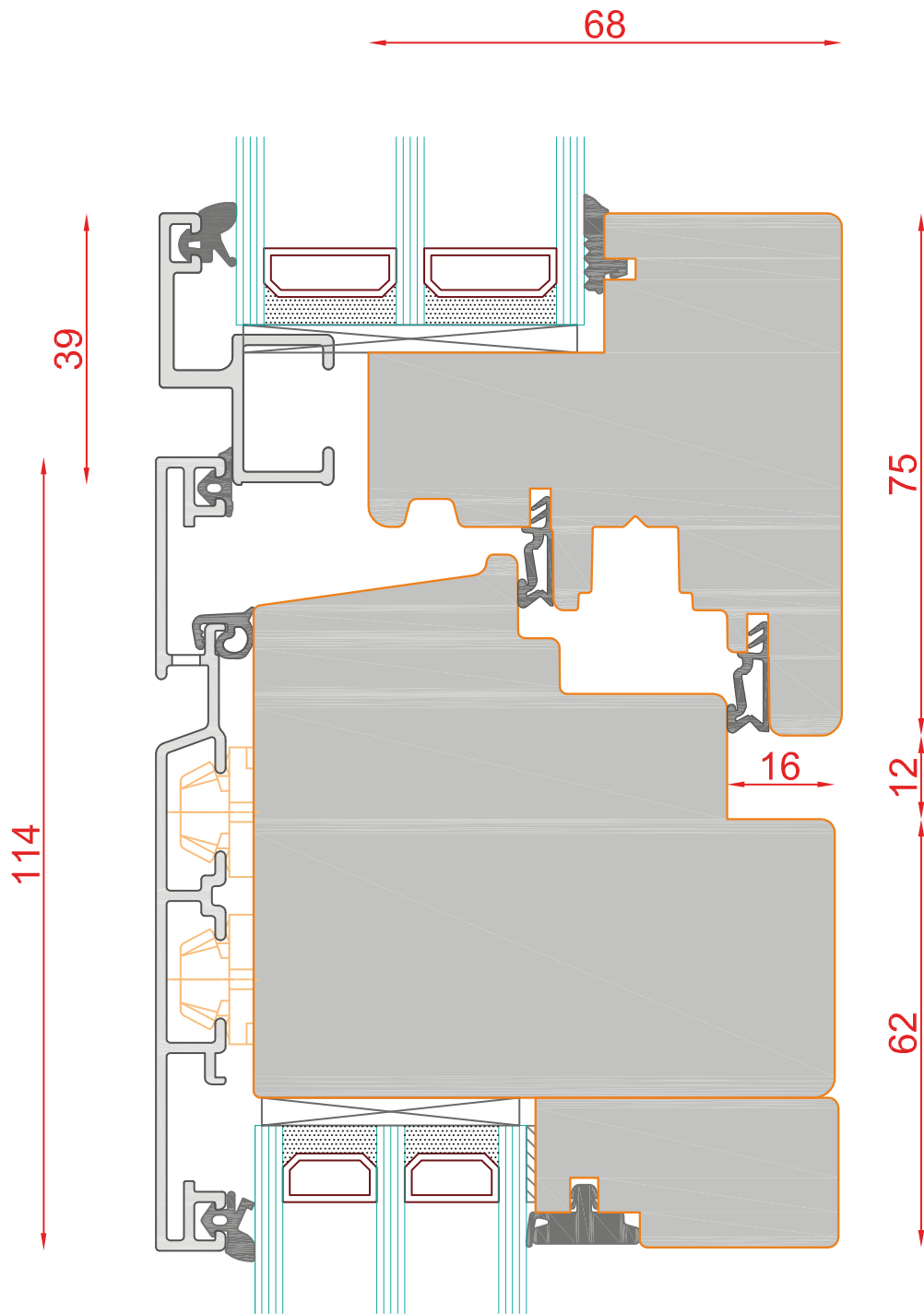

DUO 100
PLANO

Schnitt : Vertikal Kämpfer DK-FIB

Typ: FiB

| Seite: 223

SCHMIDT VISBEK
Fenster. Türen. Innovationen.



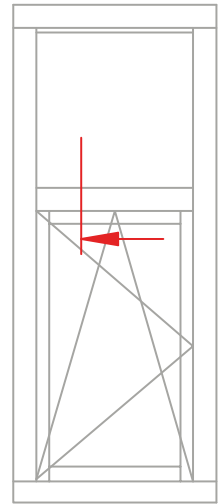
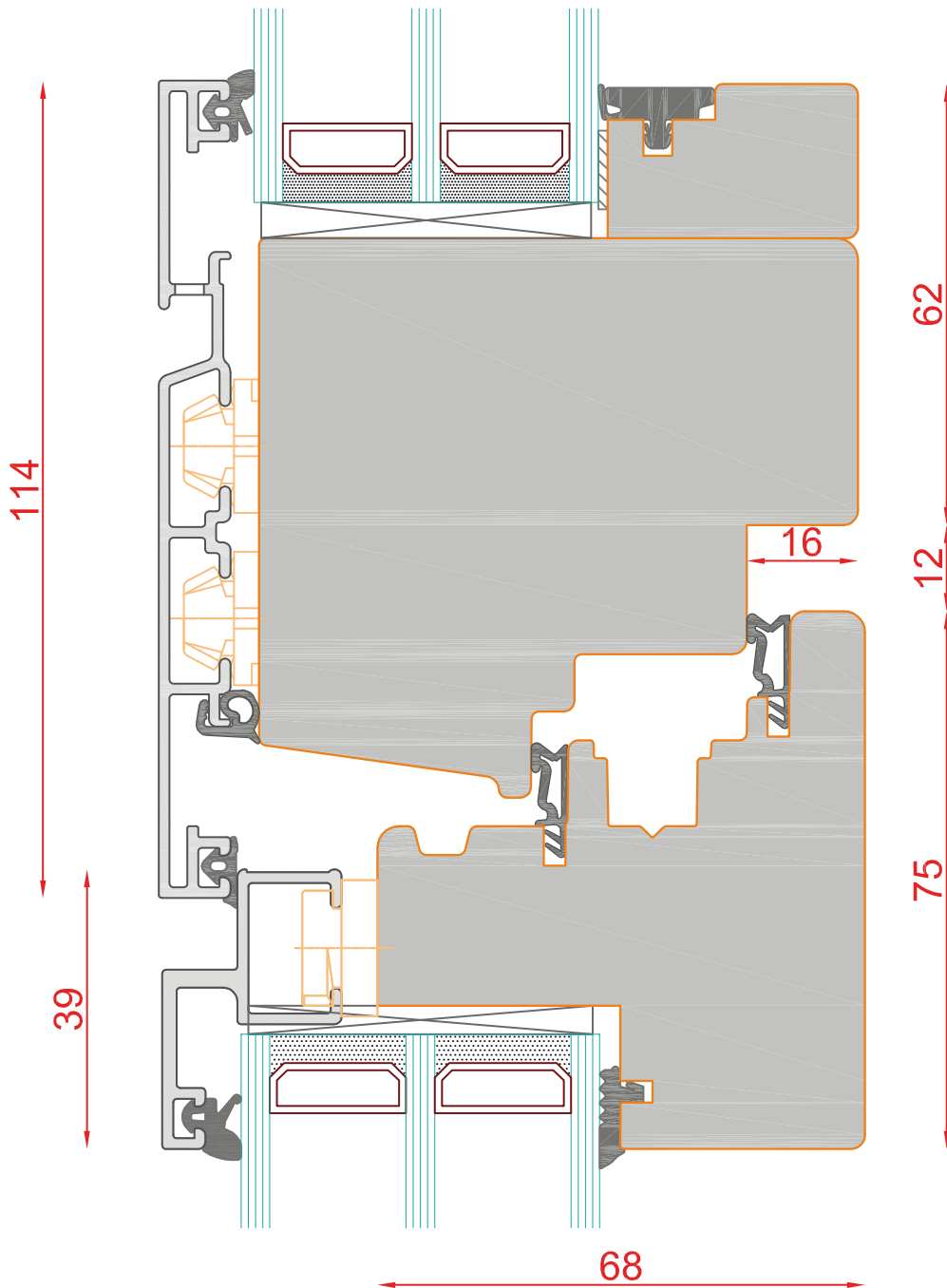

DUO 100
PLANO

Schnitt : Vertikal Kämpfer DK-FIB

Typ: FiB

| Seite: 224

SCHMIDT VISBEK
Fenster. Türen. Innovationen.

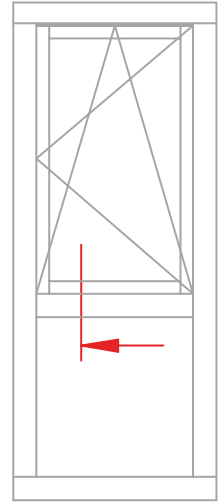
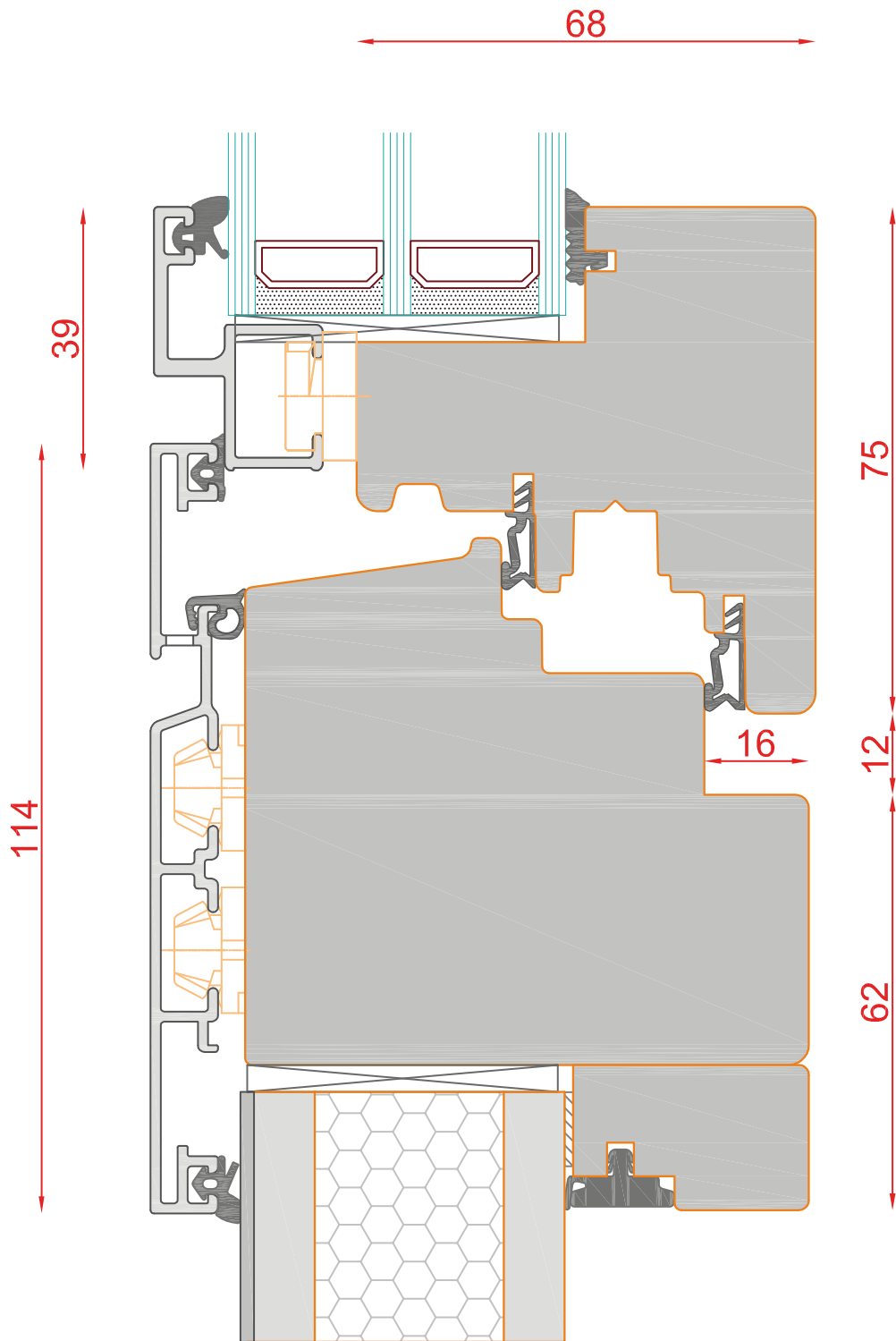

DUO 100
PLANO

Schnitt : Vertikal Kämpfer DK-FIB

Typ: Füllung

| Seite: 225

SCHMIDT VISBEK
Fenster. Türen. Innovationen.



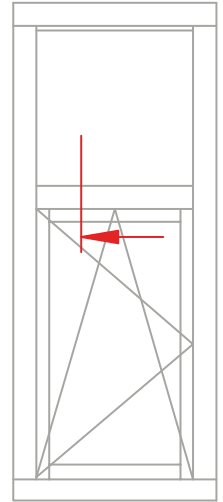
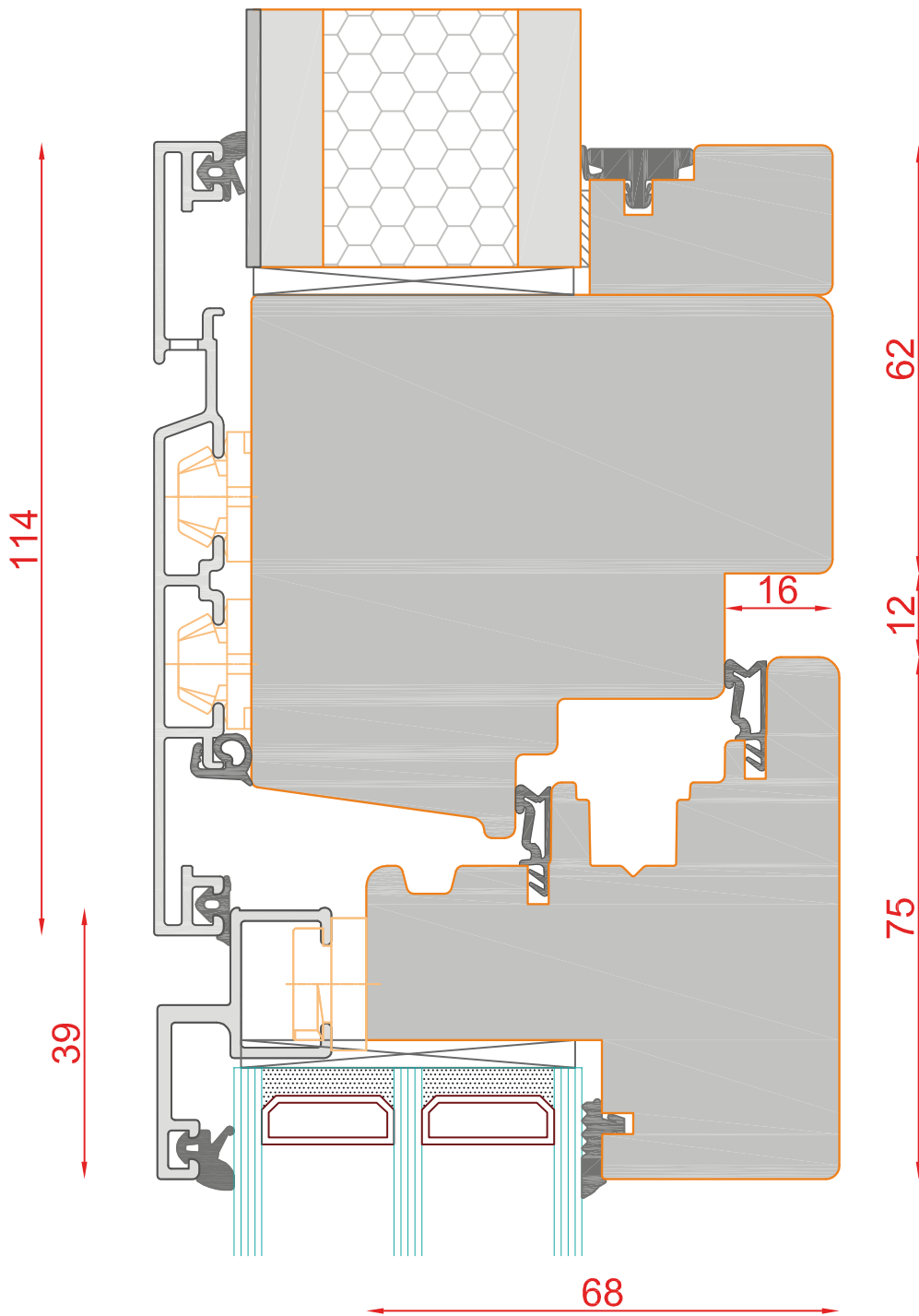

DUO 100
PLANO

Schnitt : Vertikal Kämpfer DK-FIB

Typ: Füllung

| Seite: 226

SCHMIDT VISBEK
Fenster. Türen. Innovationen.

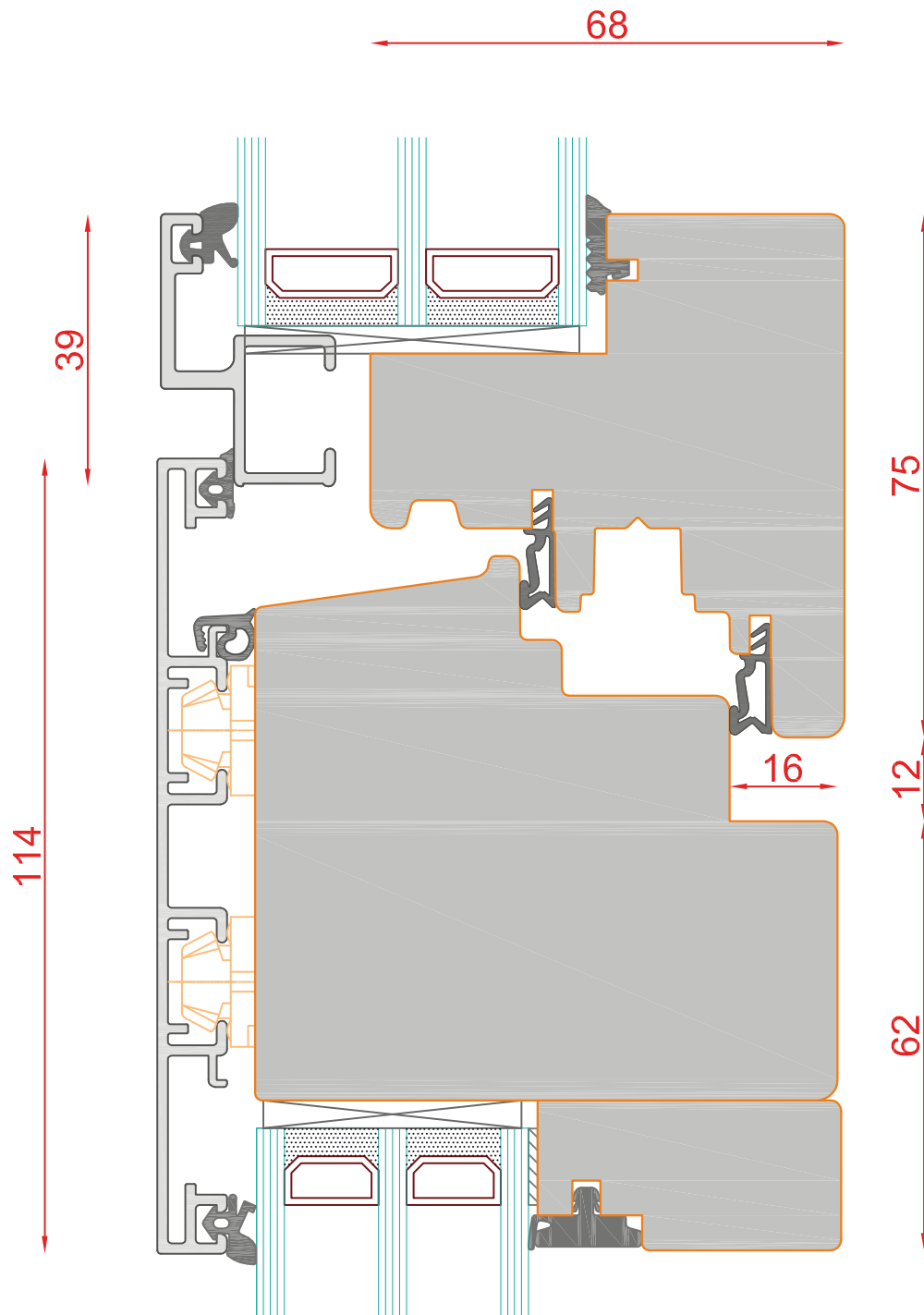
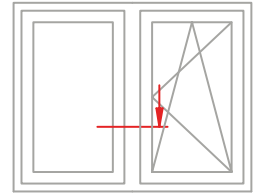

DUO 100
PLANO

Schnitt : Horizontal Mitte

Typ: DK - FIB

| Seite: 227

SCHMIDT VISBEK
Fenster. Türen. Innovationen.

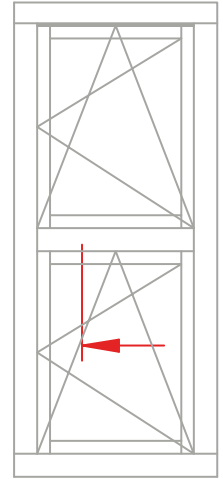
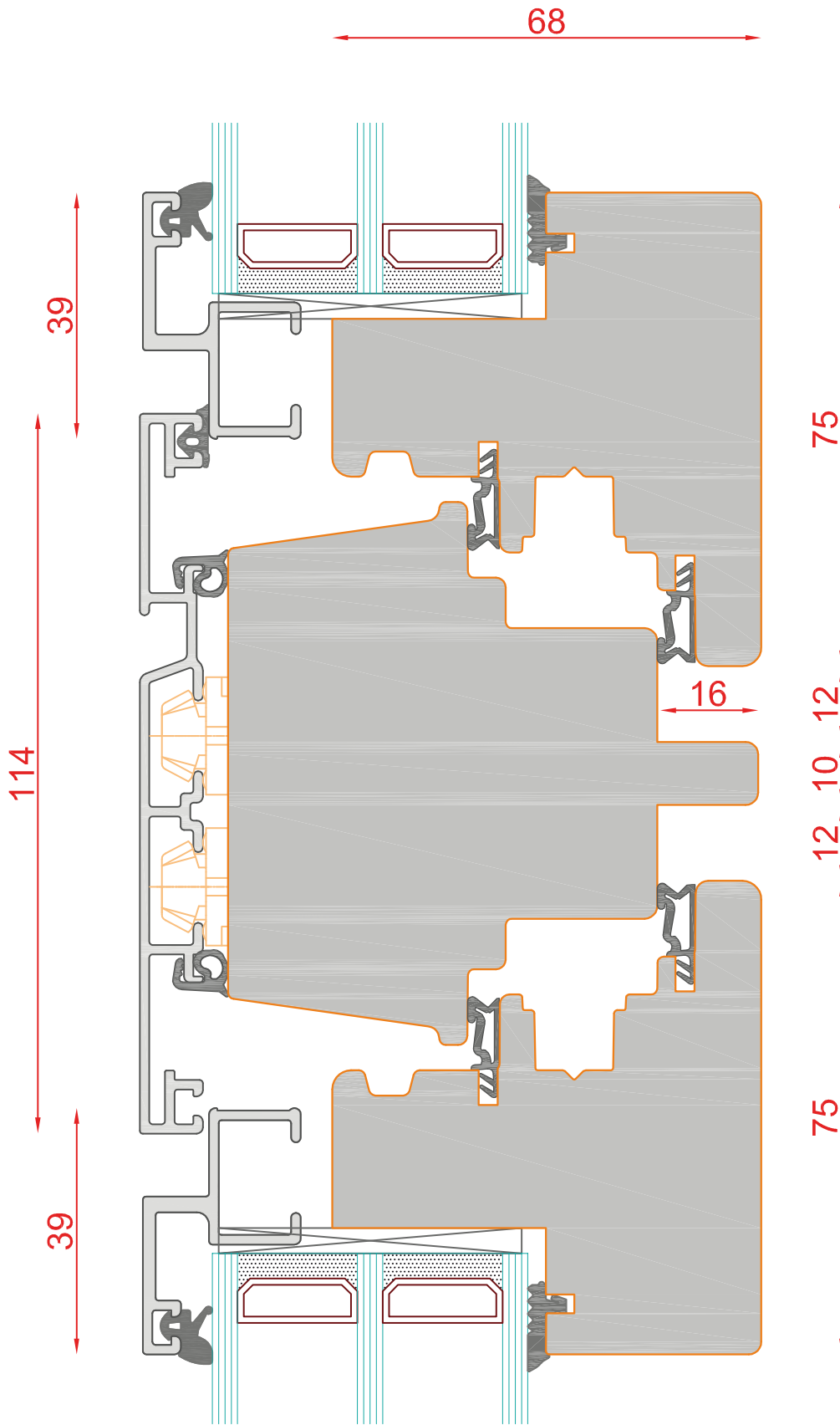

DUO 100
PLANO

Schnitt : Vertikal

Typ: Kämpfer DK - DK

| Seite: 228

SCHMIDT VISBEK
Fenster. Türen. Innovationen.



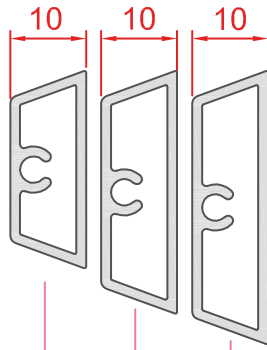

SP 36.10 = 36mm
 SP 32.10 = 32mm
 SP 26.10 = 26mm

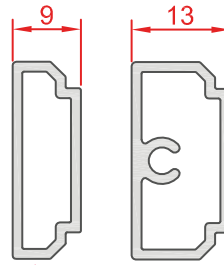

SP 26.13-SK = 26mm
 SP 26.9-SK = 26mm

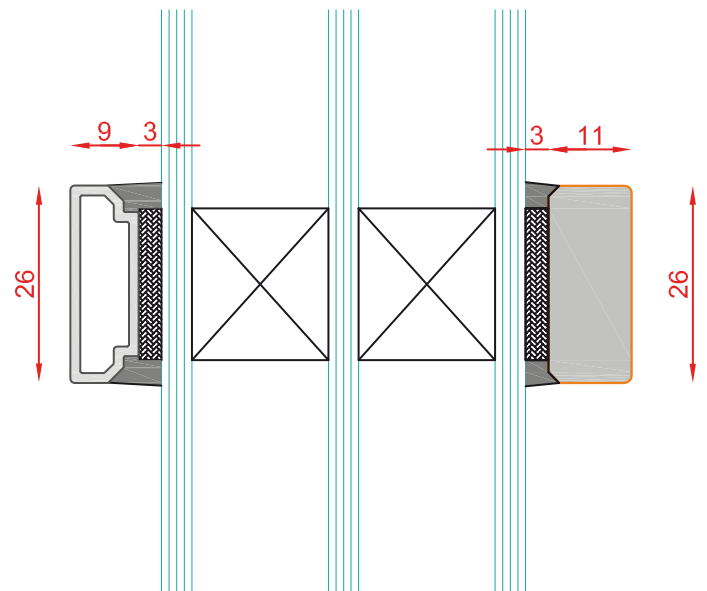
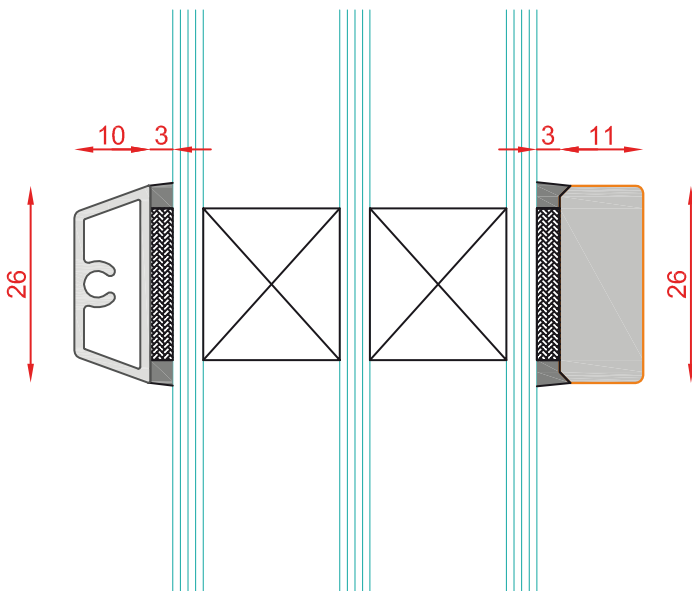
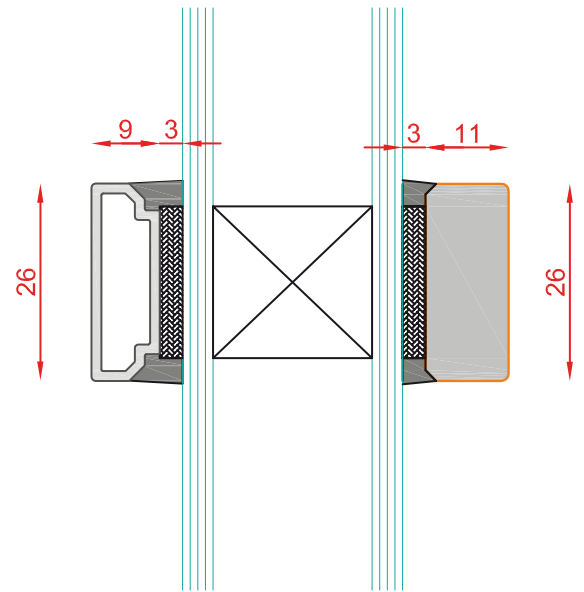
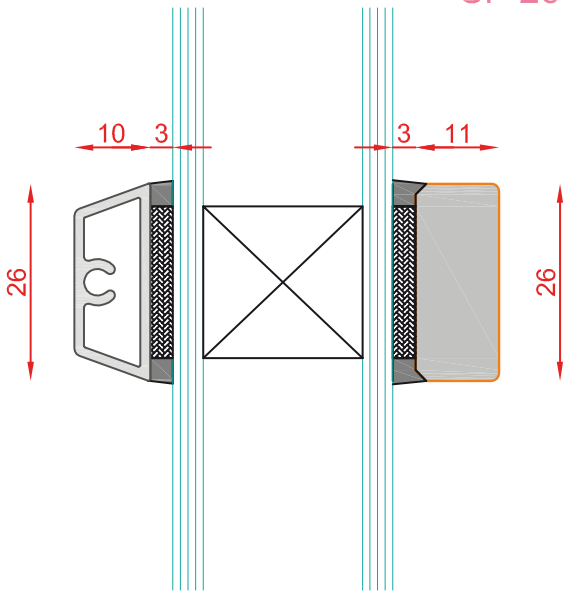

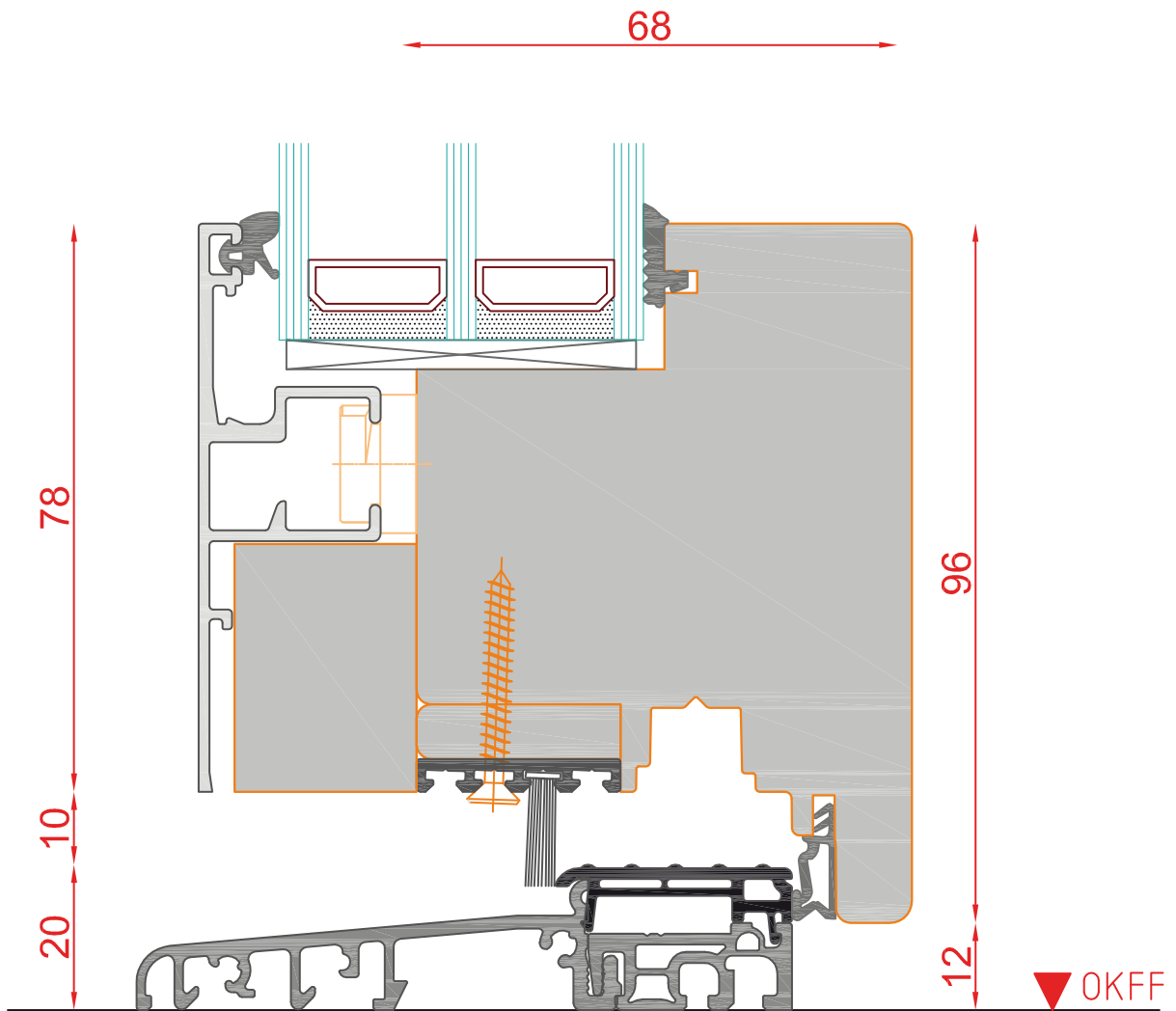
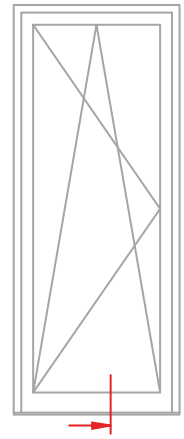

Bodenschwelle BKV Eifel 90 TB



DUO 100
PLANO

Schnitt : Vertikal unten

Eifel Schiene 20mm

| Seite: 230

SCHMIDT VISBEK
Fenster. Türen. Innovationen.

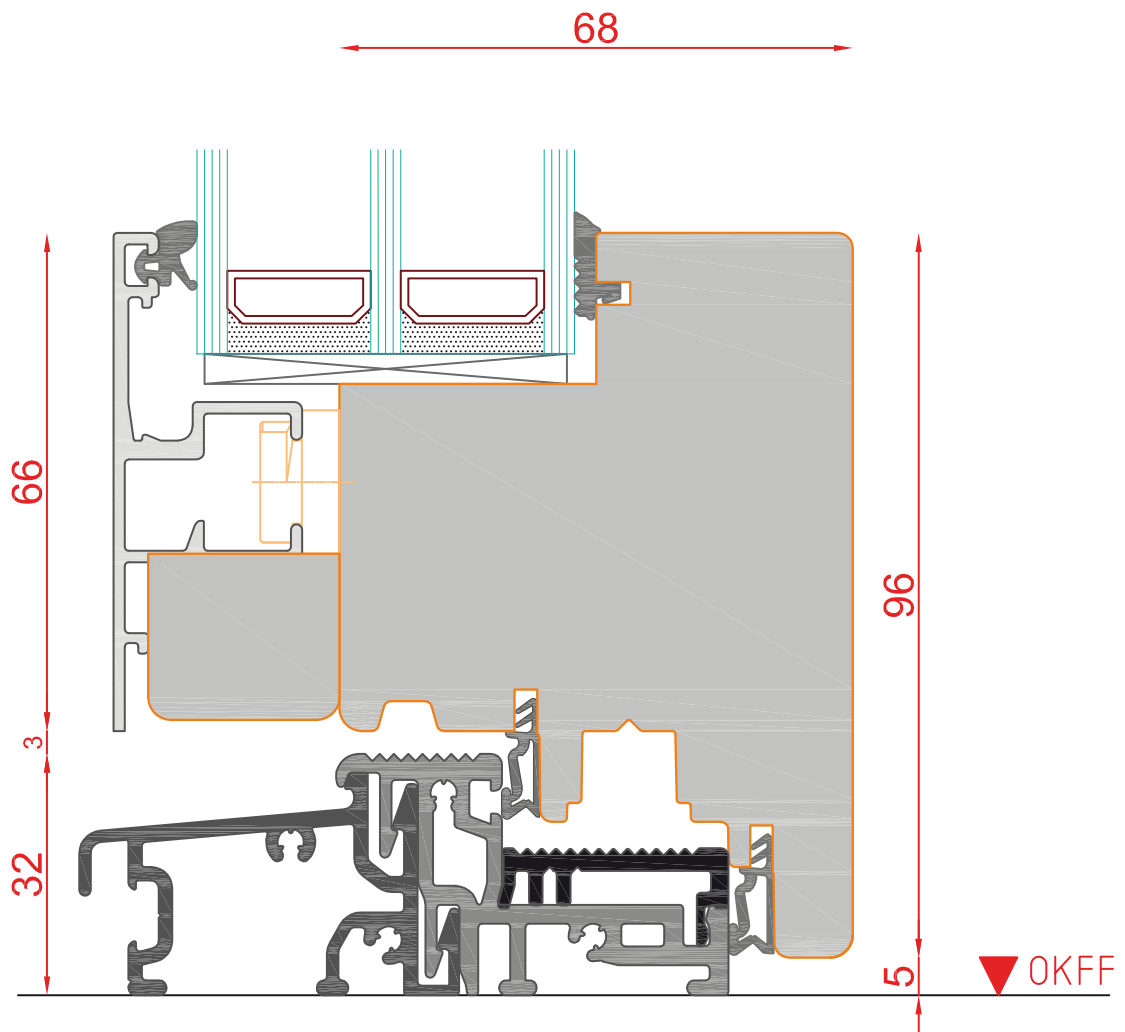
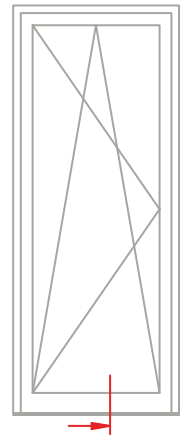

Bodenschwelle Weser 86/32 Ti



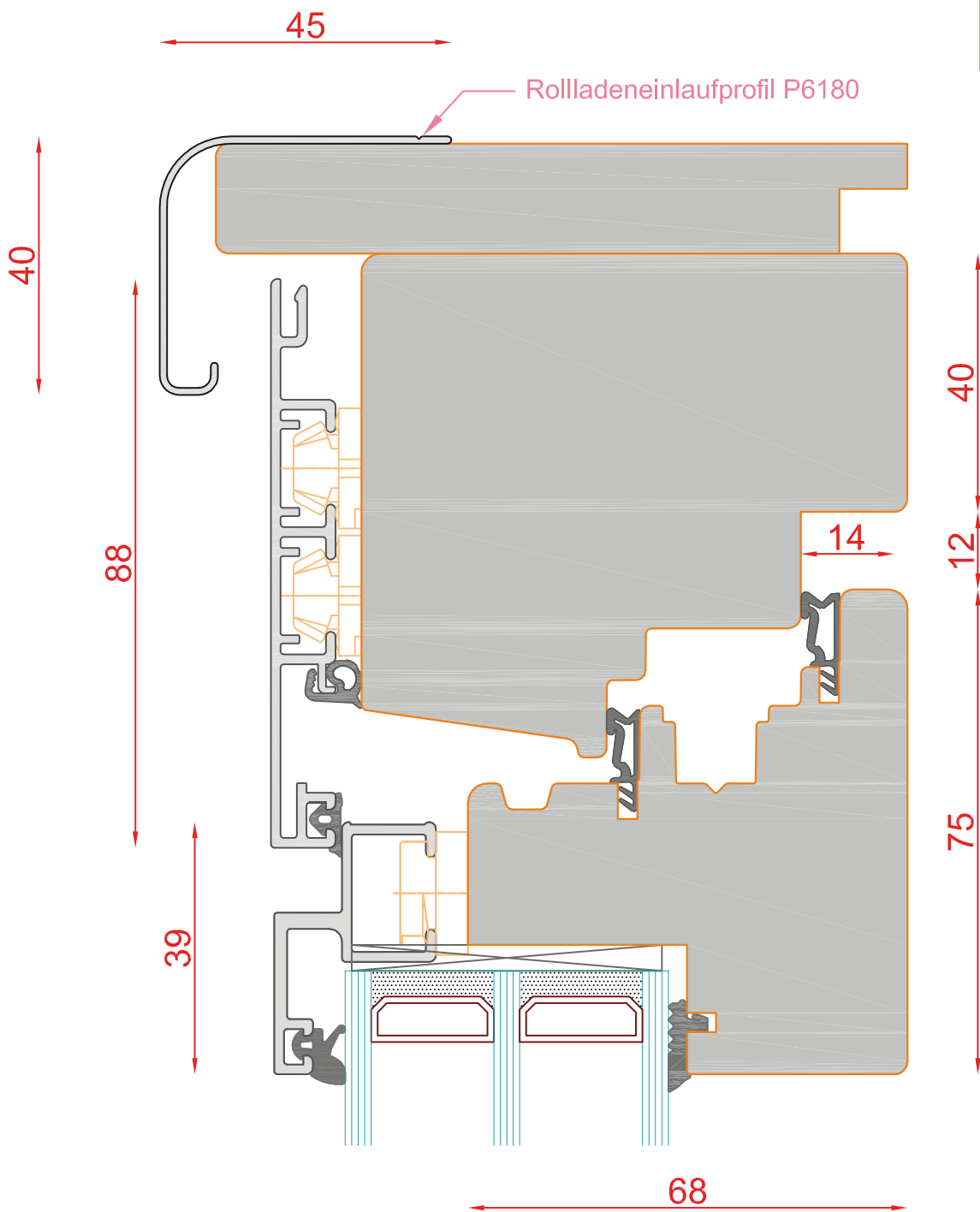
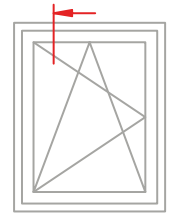

DUO 100
PLANO

Schnitt : Horizontal seitlich und oben

Typ: DK

| Seite: 232

SCHMIDT VISBEK
Fenster. Türen. Innovationen.

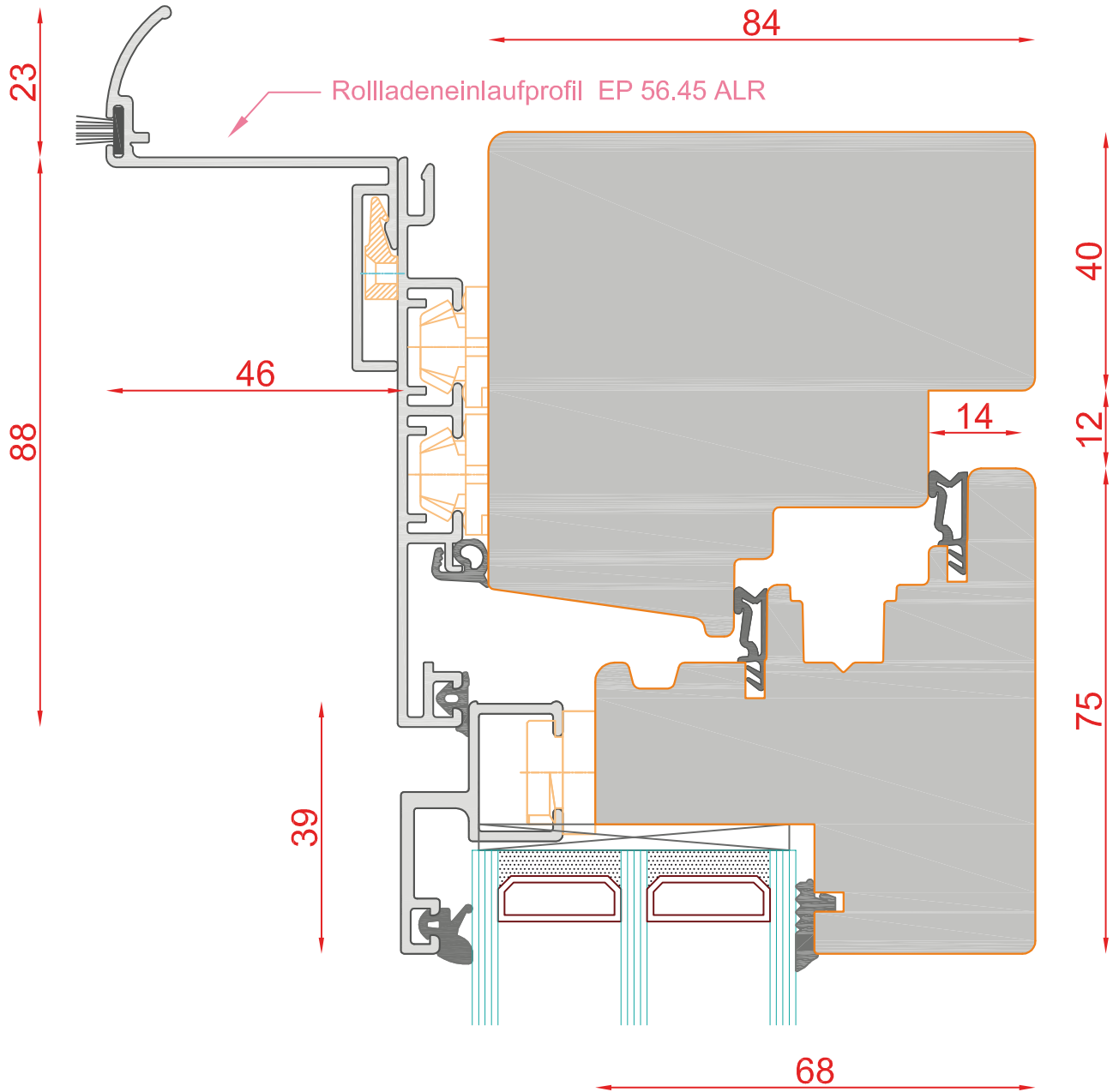
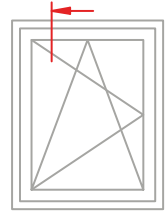

DUO 100
PLANO

Schnitt : Horizontal seitlich und oben

Typ: DK

| Seite: 234

SCHMIDT VISBEK
Fenster. Türen. Innovationen.

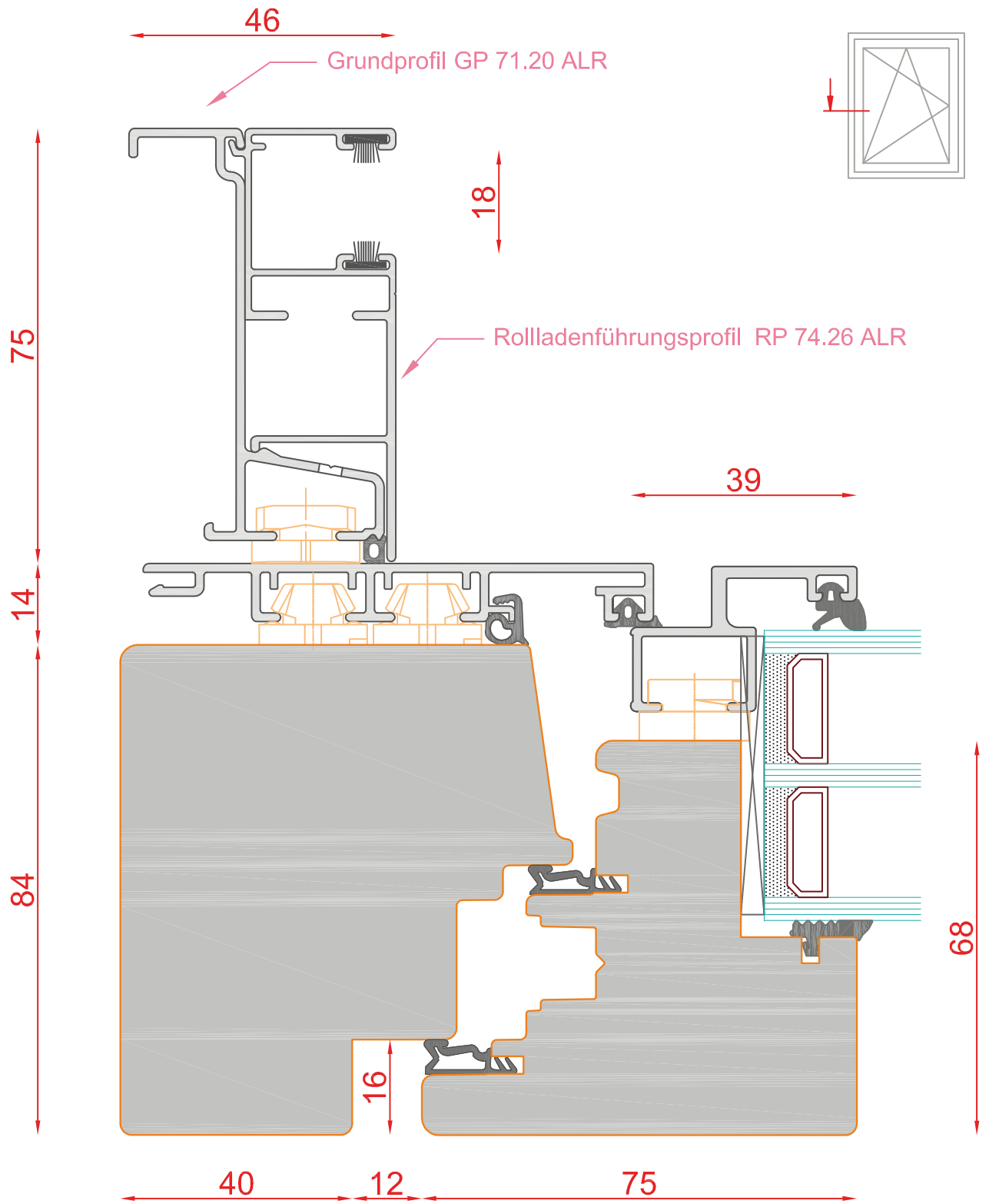

HAUSTÜREN

Pronto

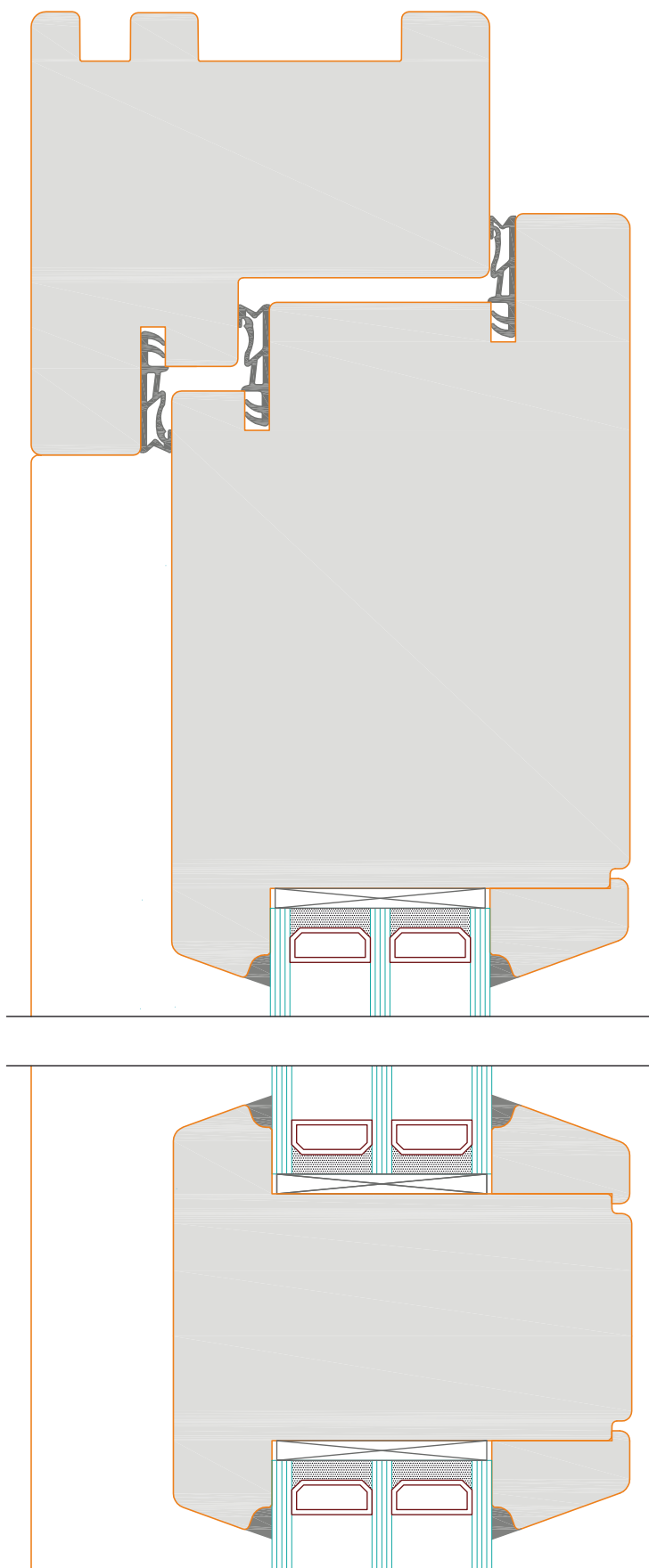

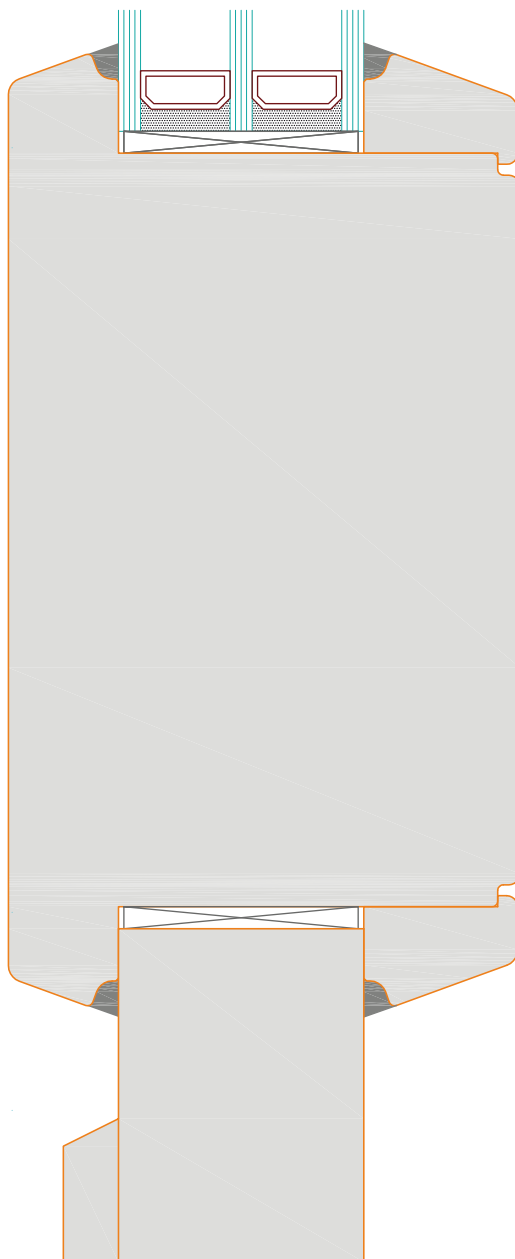

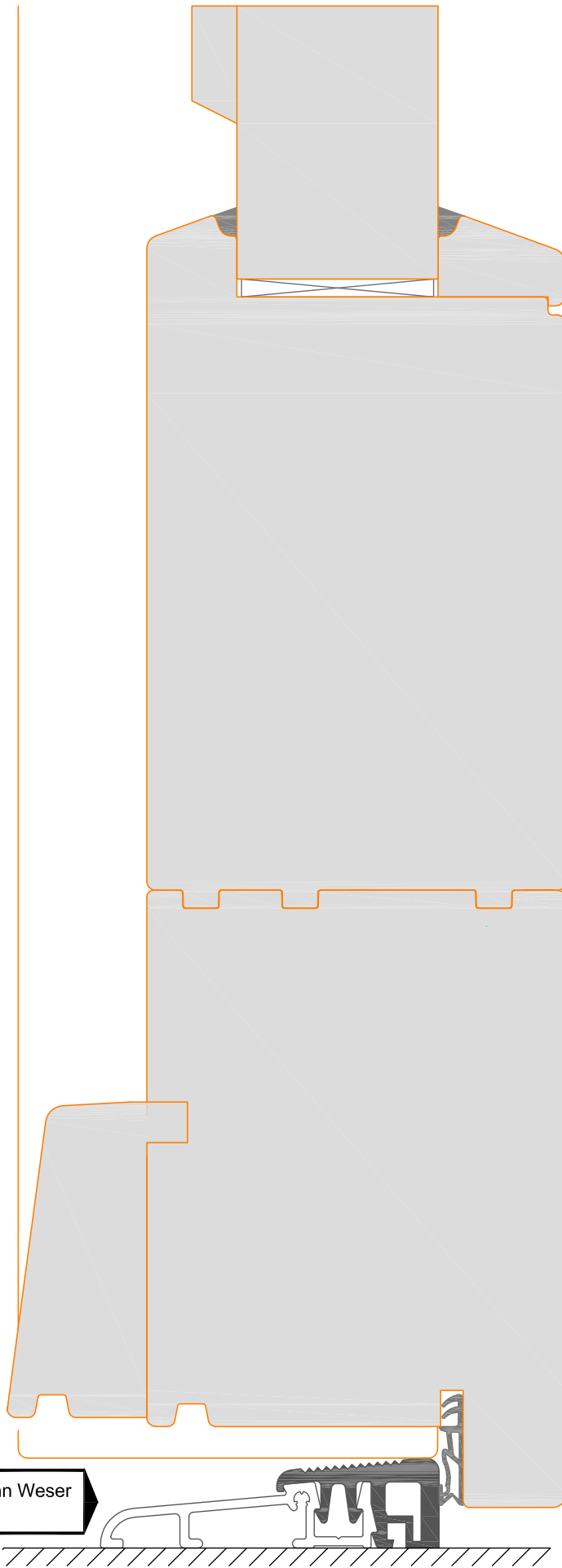

Bodenschwelle Gutmann Weser
75/20 TI



HAUSTÜREN
PRONTO

Typ: IV 93 Holz Haustür, Pronto

Schnitt : Vertikal | Seite: 239

Typ: IP 93 Holz Haustür, Pronto

Schnitt : Horizontal

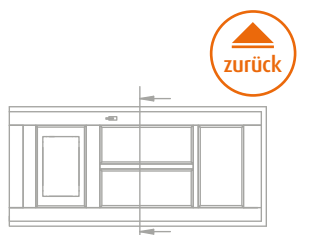
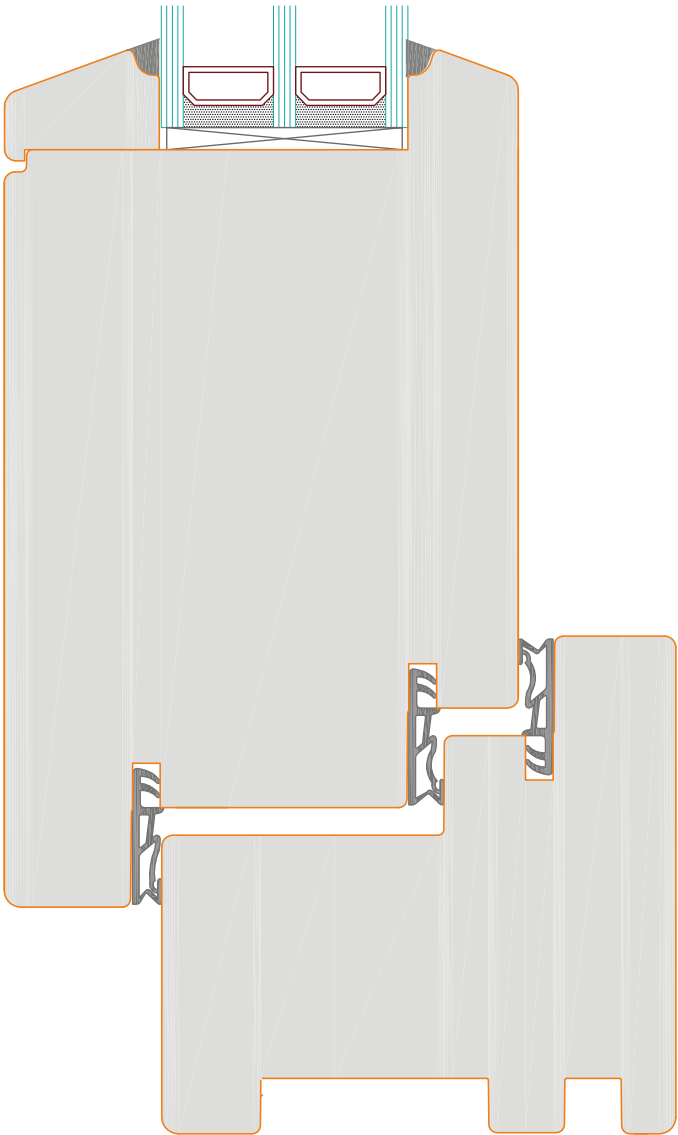

Typ: IP 93 Holz Haustür, Pronto

Schnitt : Horizontal

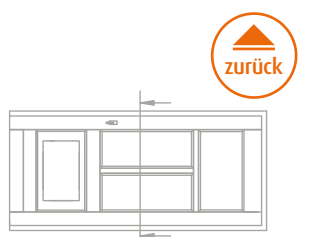
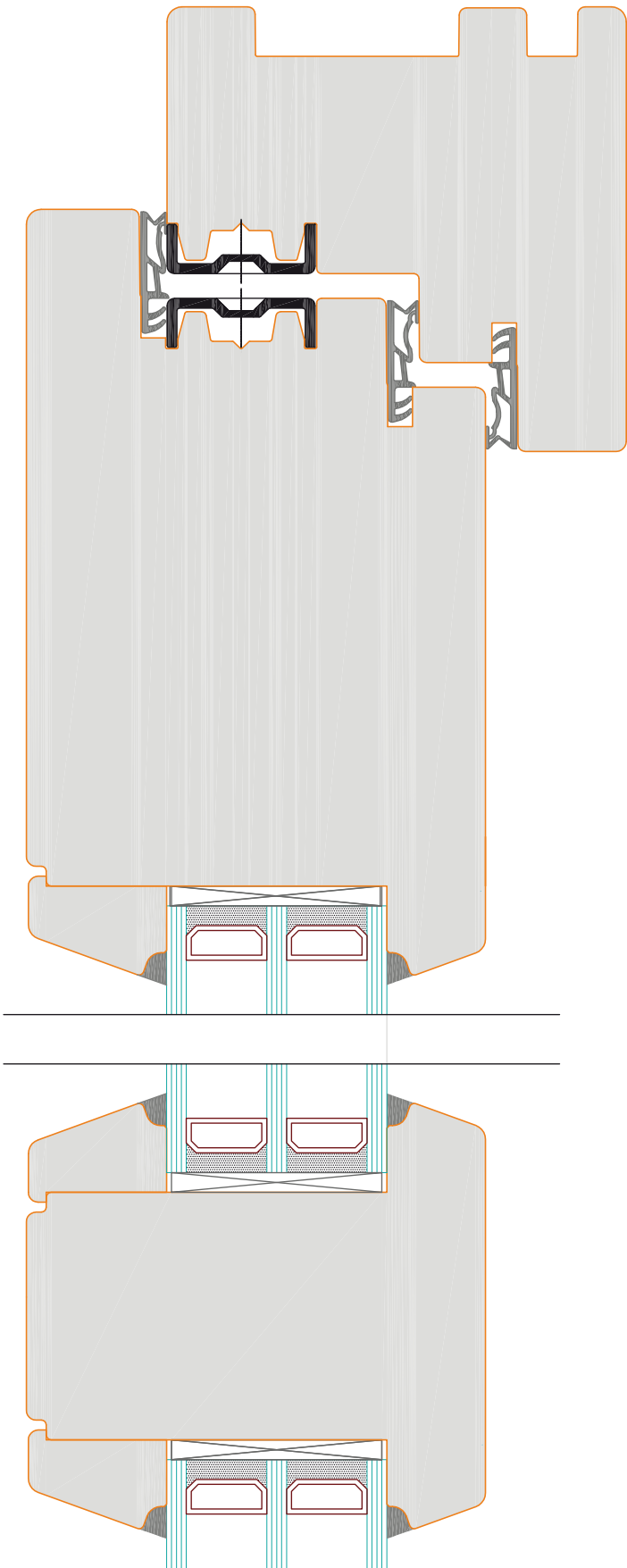

HAUSTÜREN

Classico

242

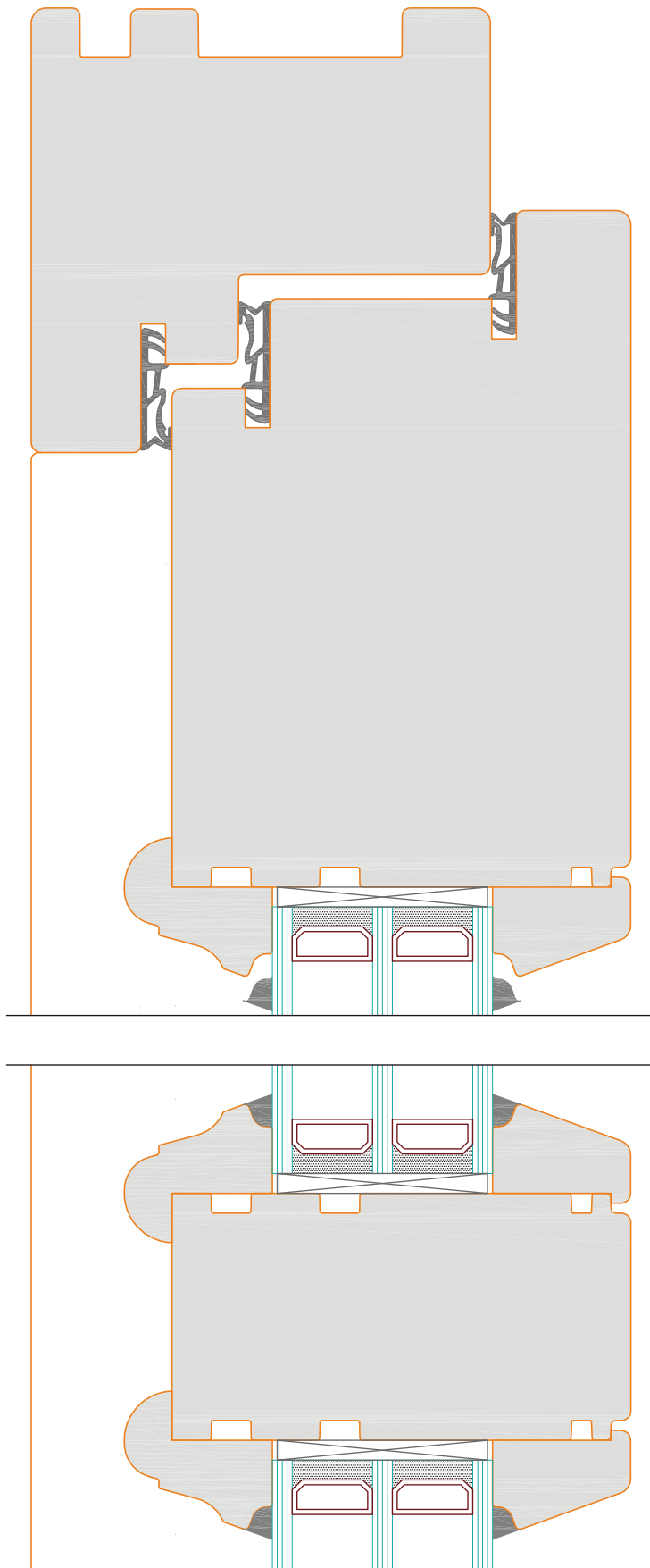

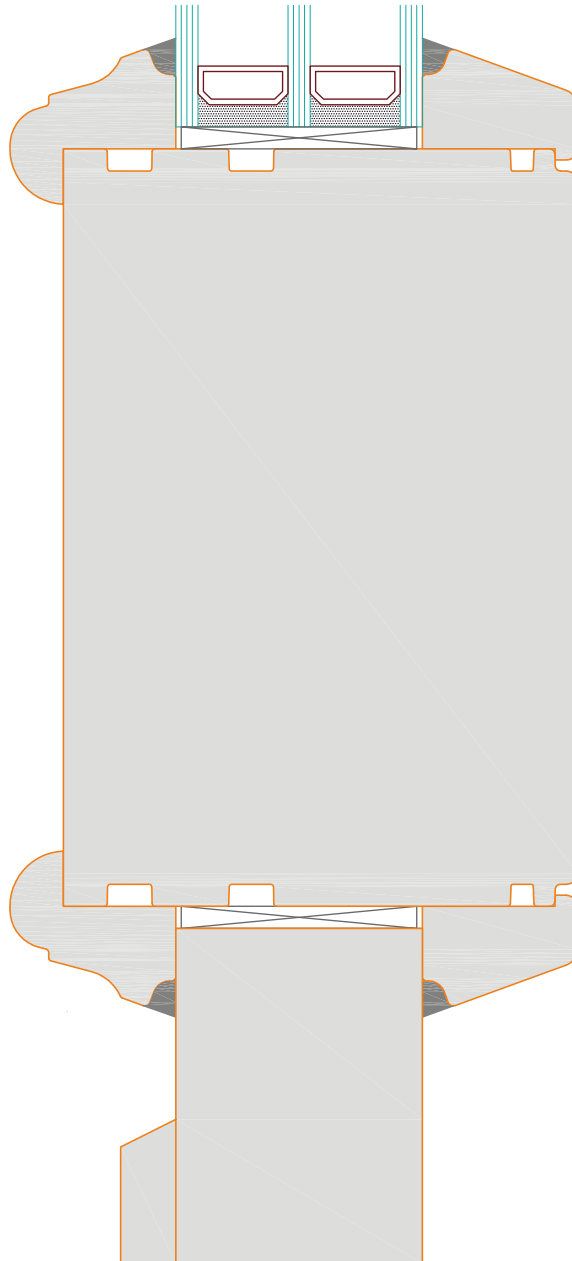

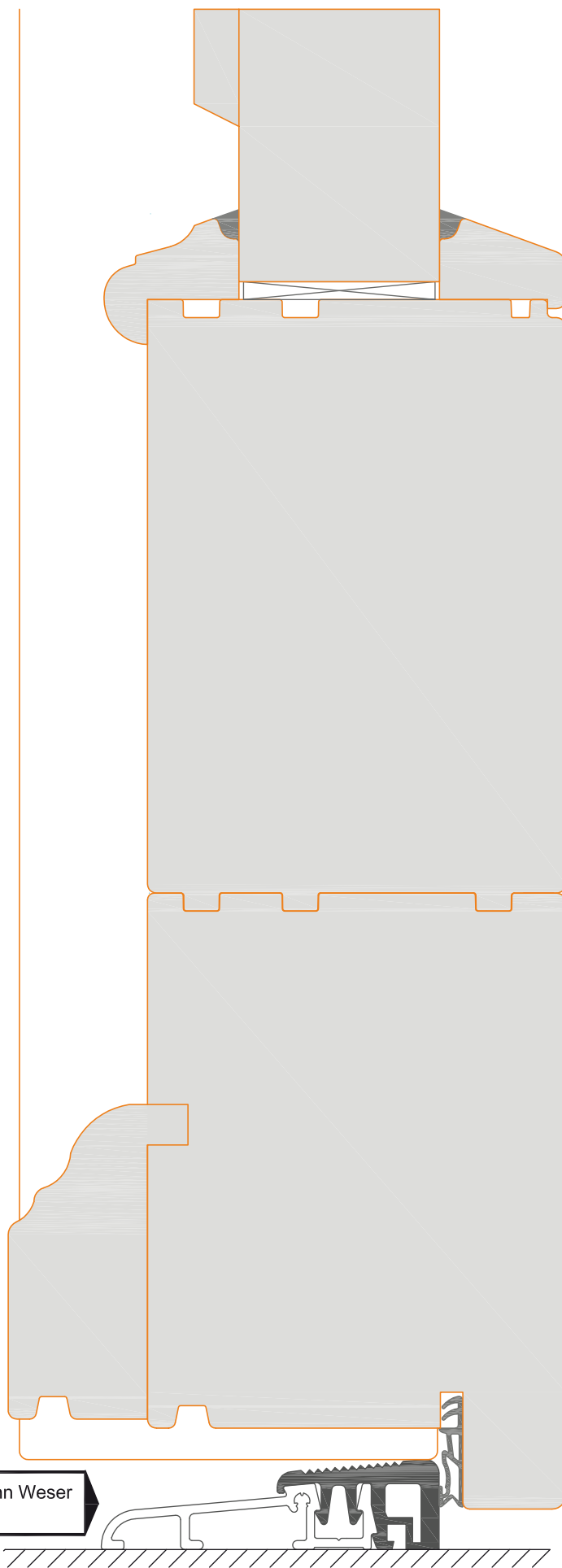

Bodenschwelle Gutmann Weser
75/20 T1



HAUSTÜREN
CLASSICO

Typ: IV 93 Holz Haustür, Classico

Schnitt : Vertikal | Seite: 245

Typ: IP 93 Holz Haustür, Classico

Schnitt : Horizontal

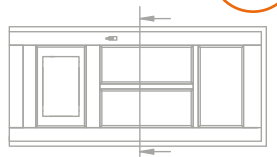
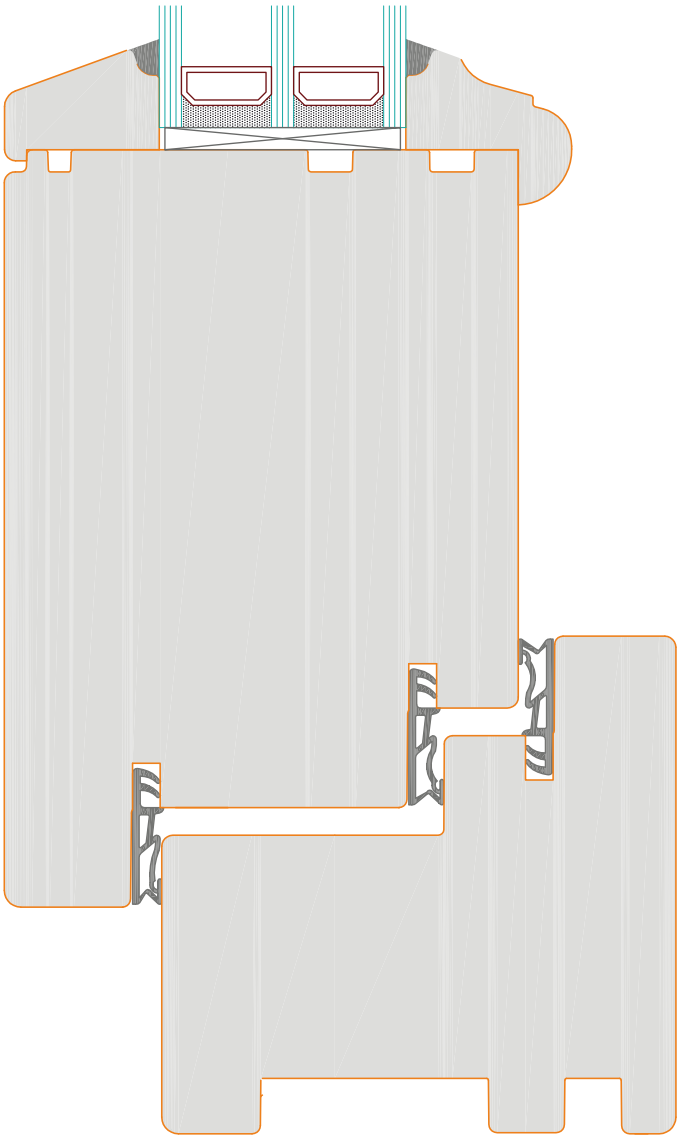

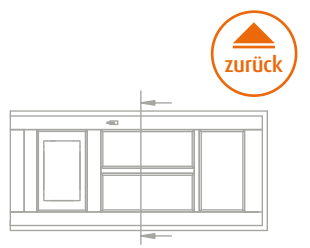
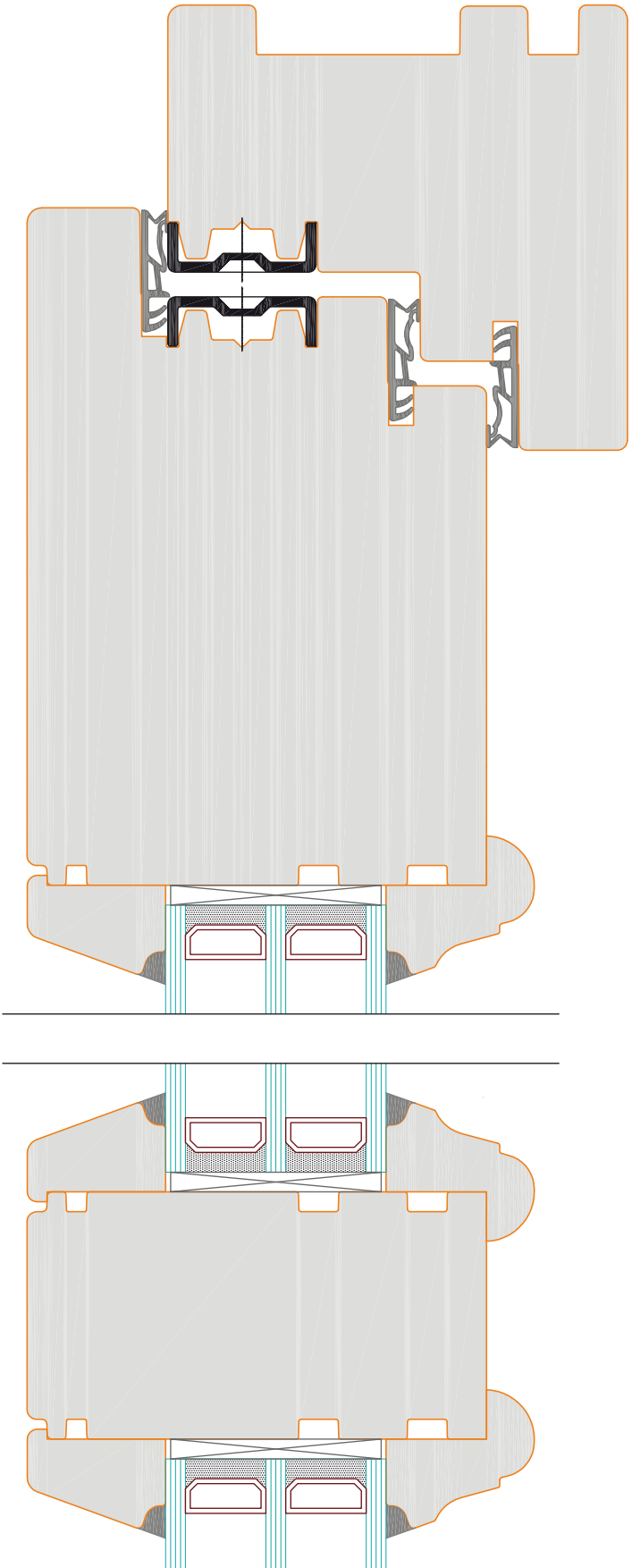

HAUSTÜREN

Holz-Alu
flächenbündig

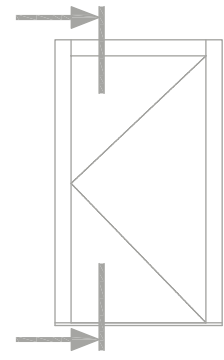
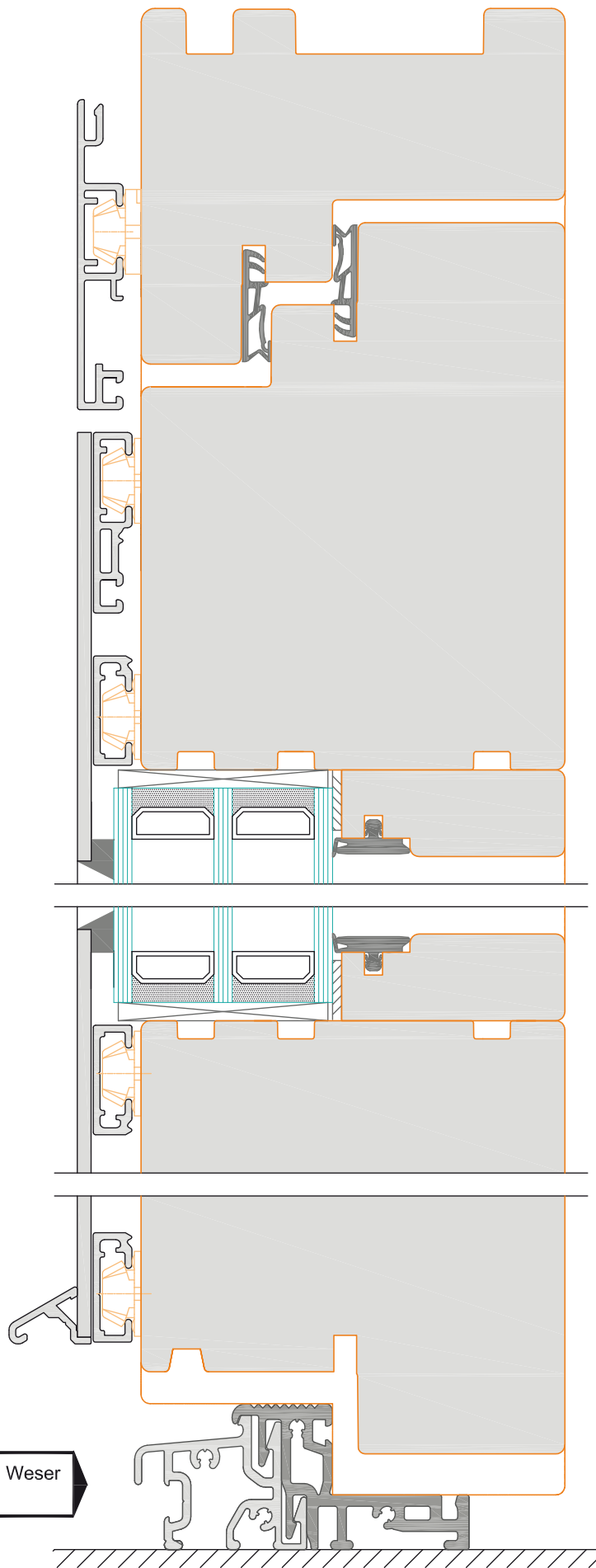

Bodenschwelle Gutmann Weser
75/32 TI



HAUSTÜREN
HOLZ-ALU FLÄCHENBÜNDIG

Typ: IV 93 Holz / Alu Haustür, Flächenbündig

Schnitt : Vertikal | Seite: 249

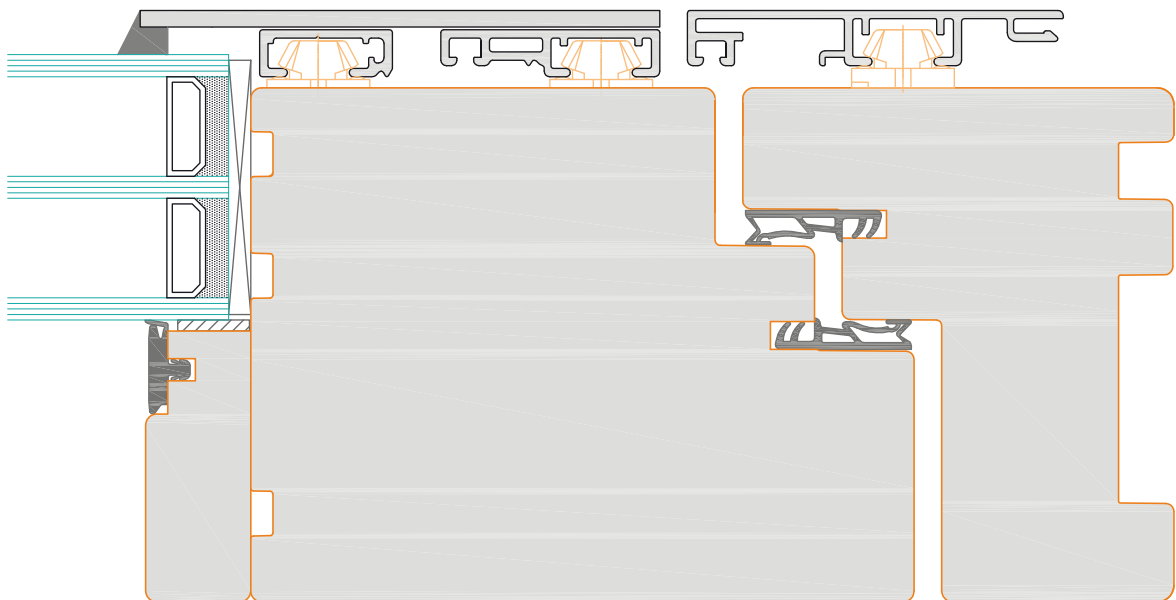
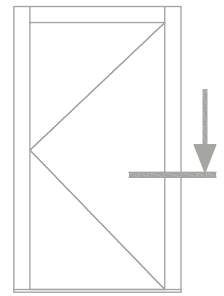

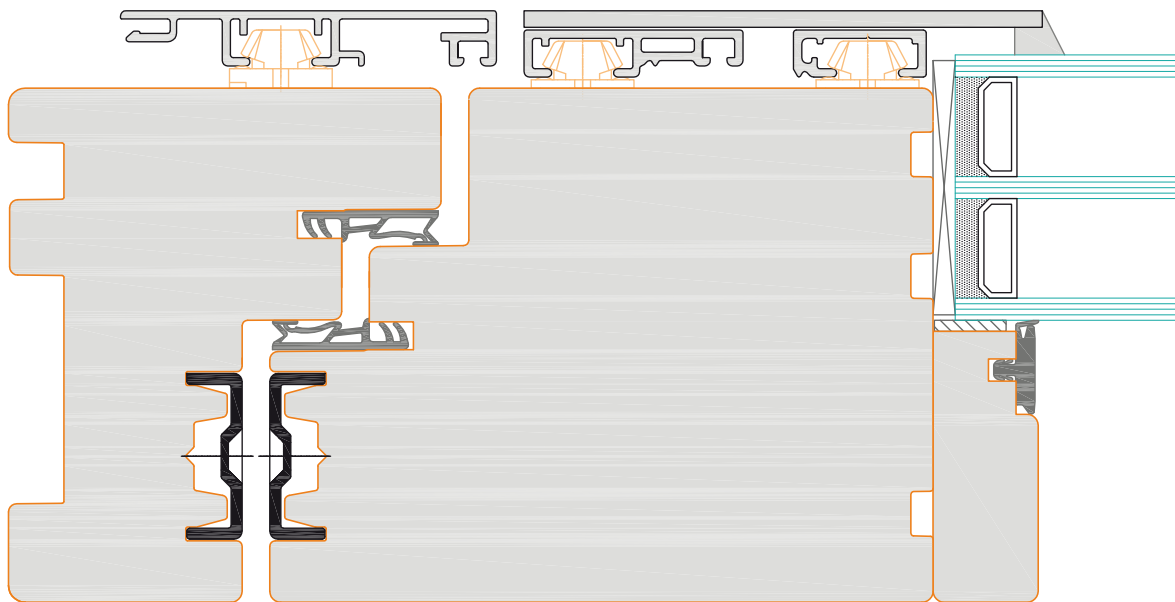
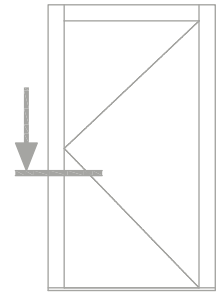

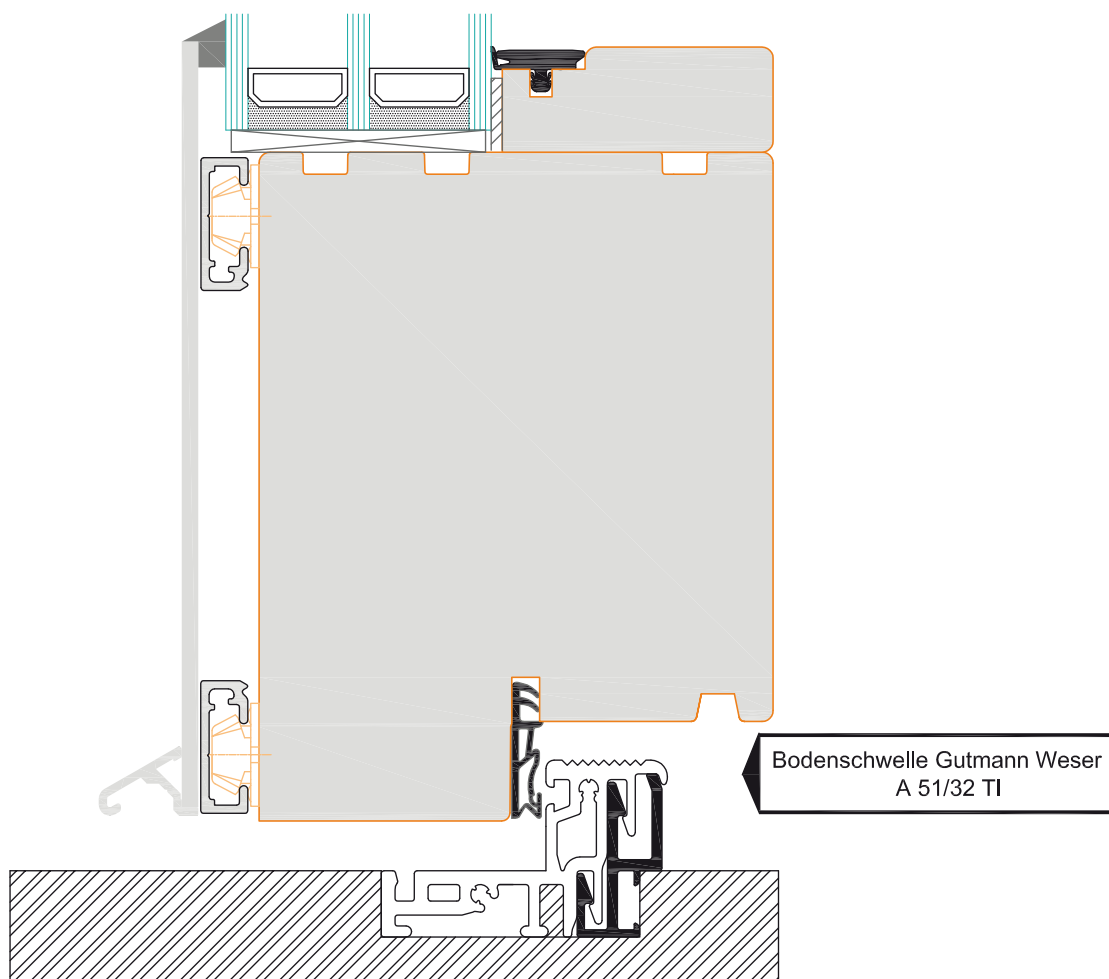
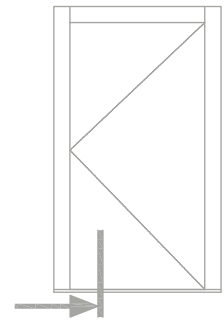

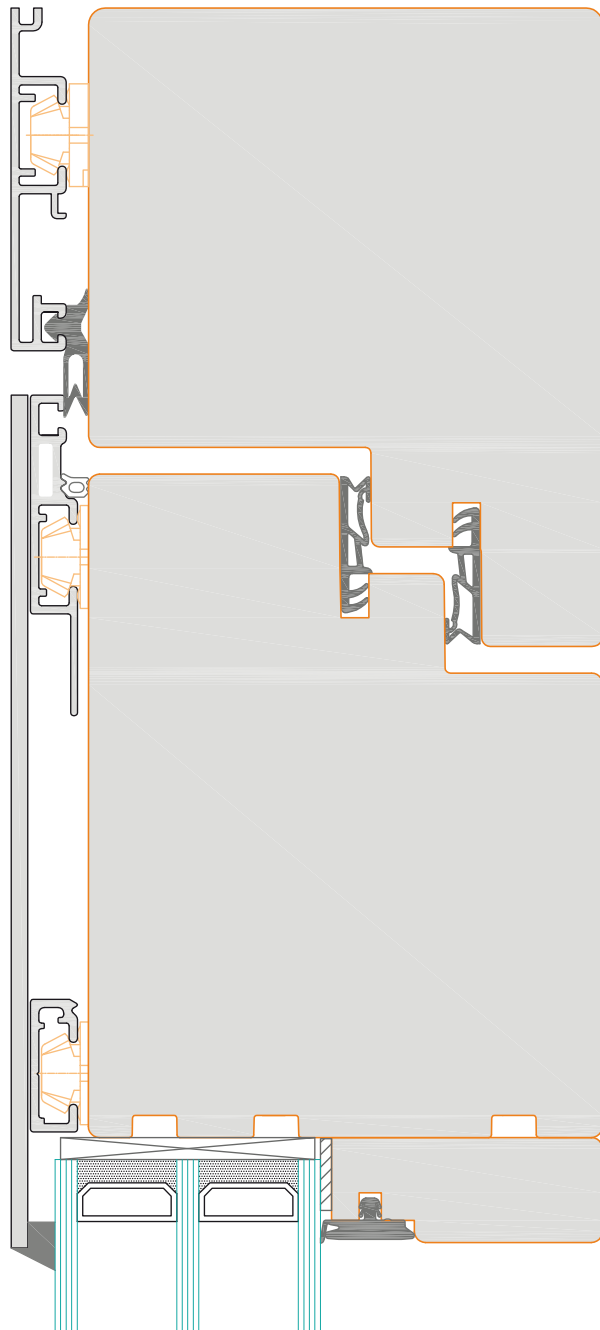
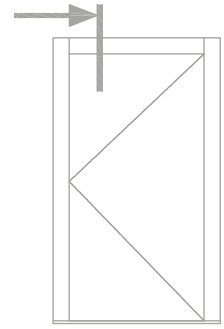

HAUSTÜREN

Holz-Alu
flächenversetzt

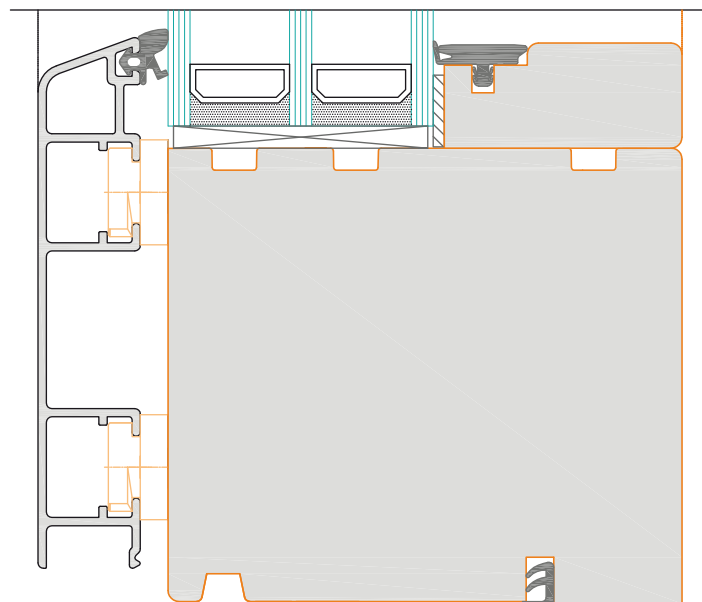
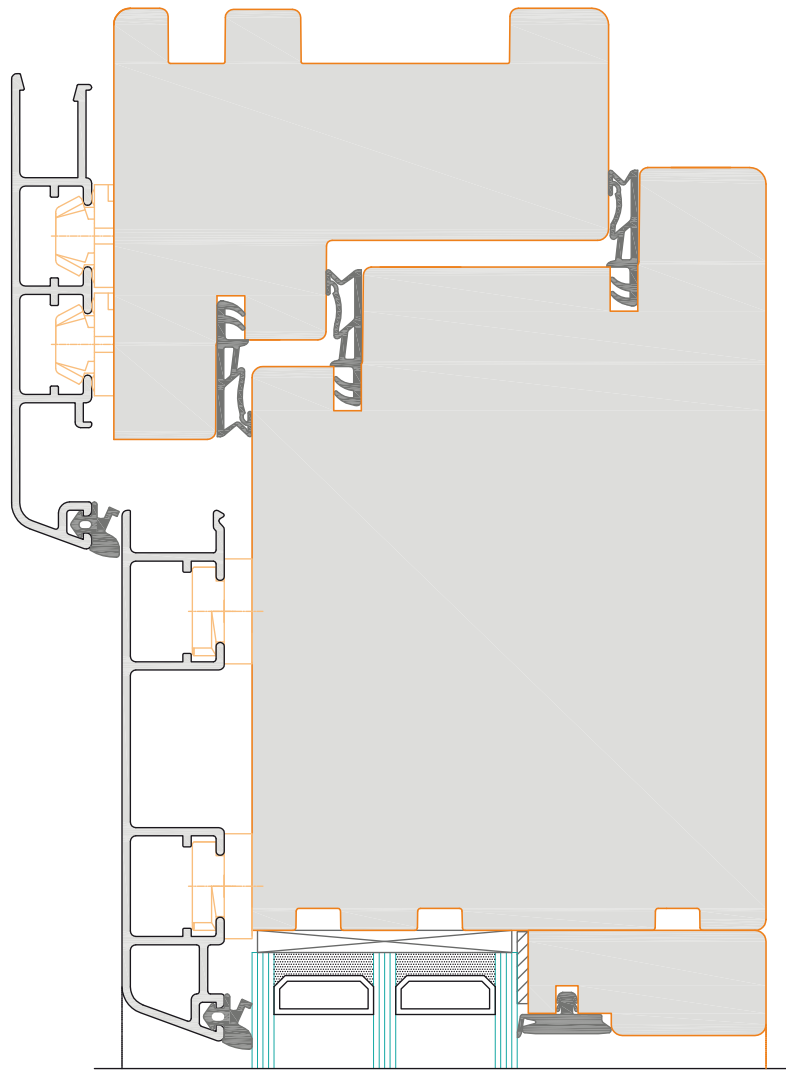

Bodenschwelle Gutmann Weser
95/20 TI

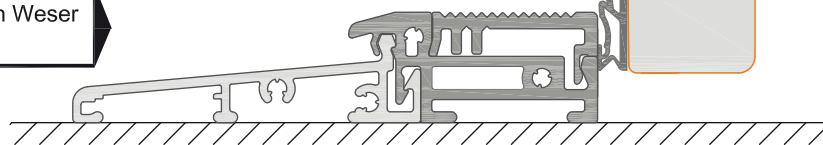

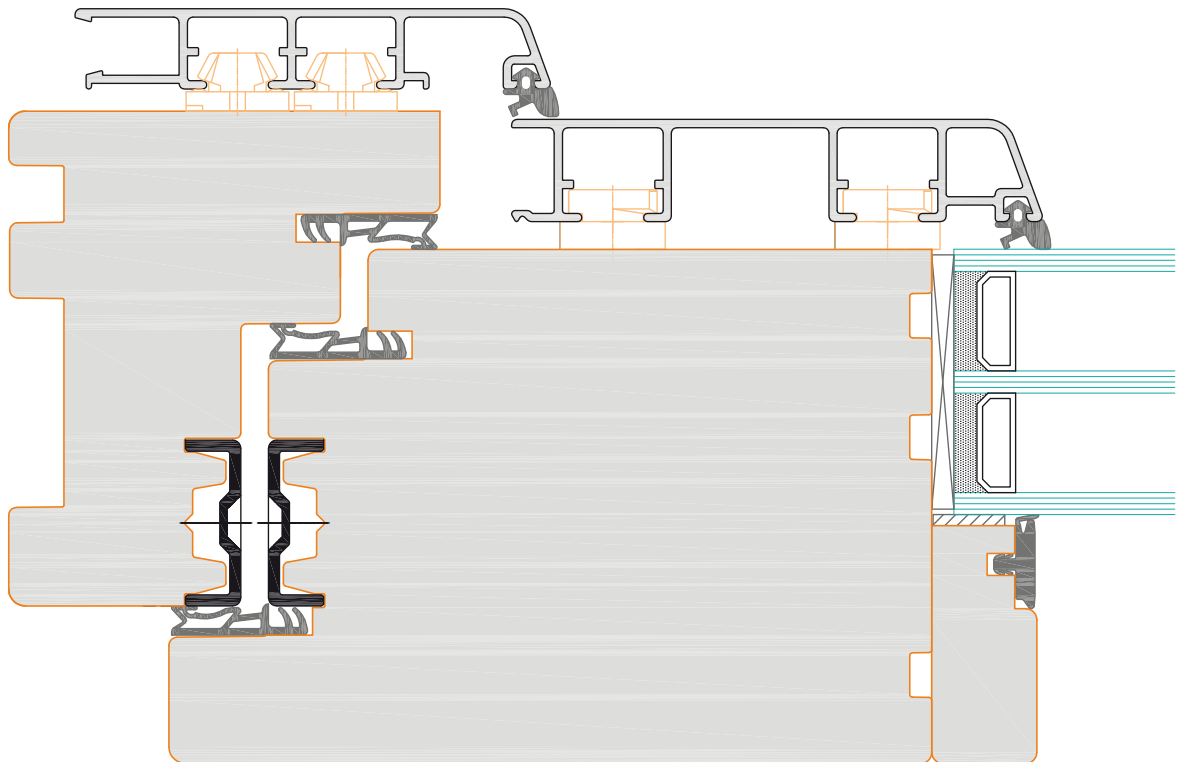
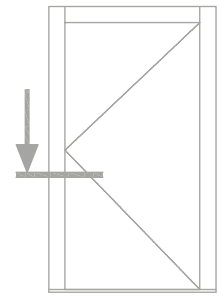

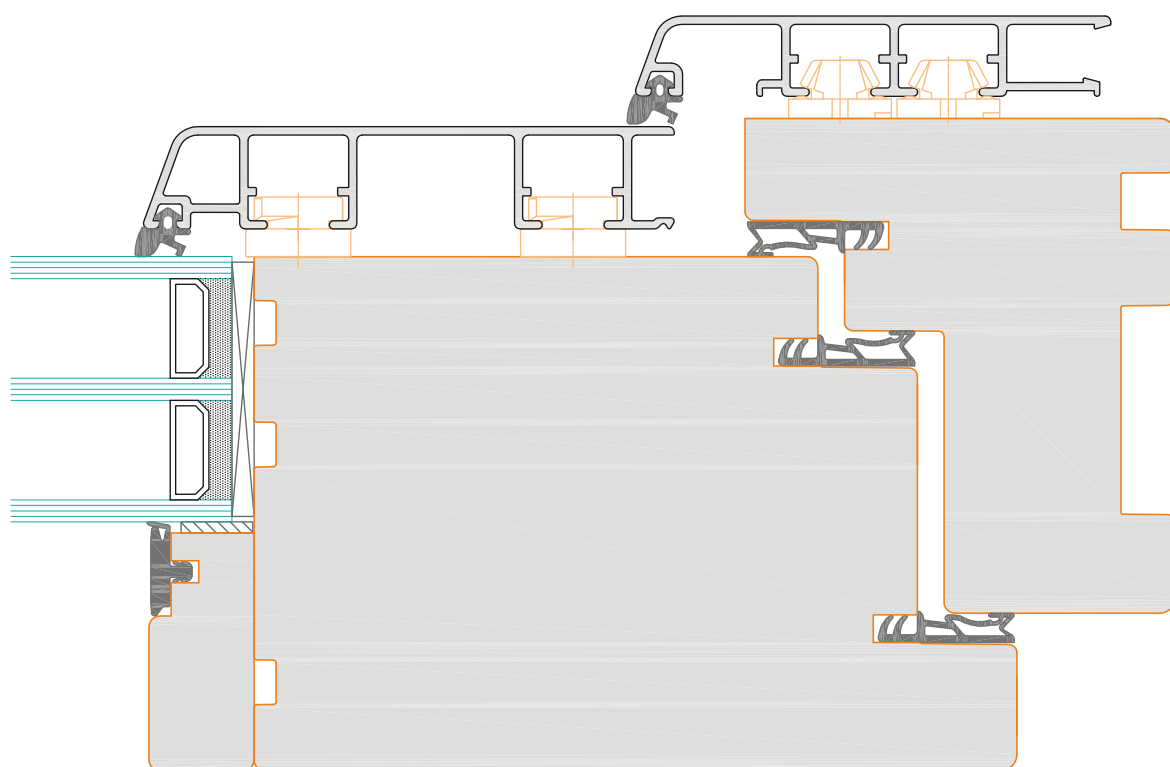
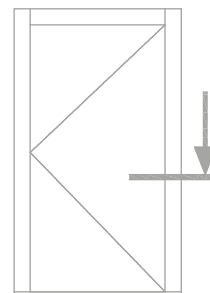

IP-DOOR

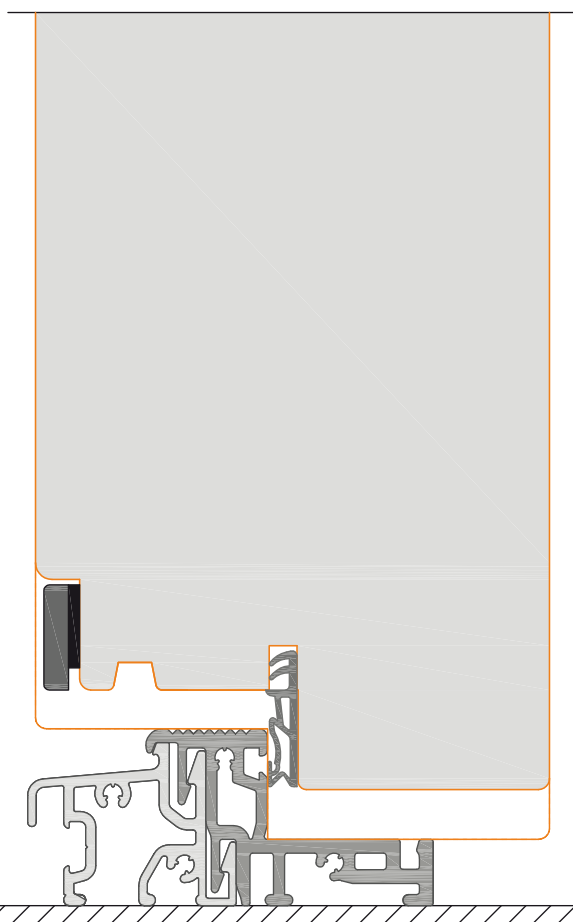
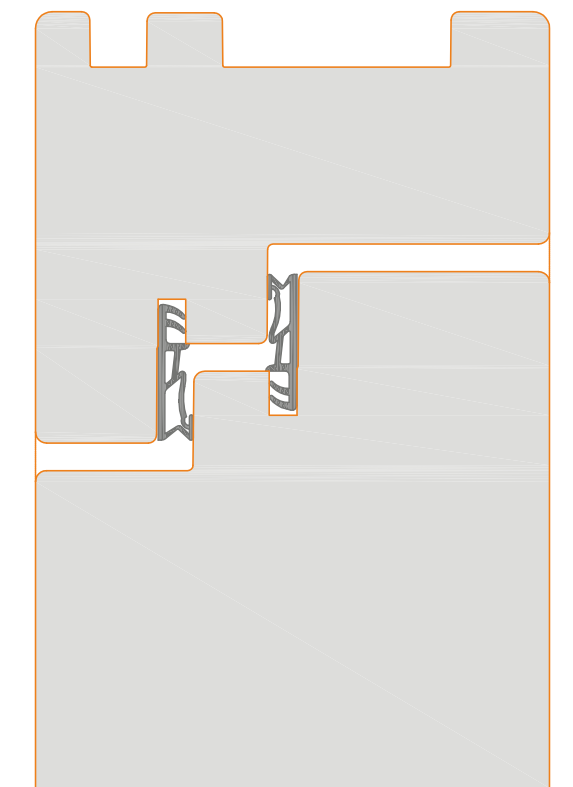
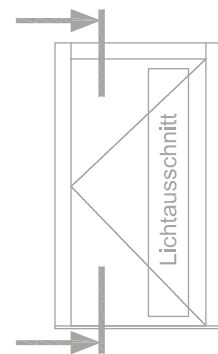

Bodenschwelle Gutmann Weser
75/32 TI



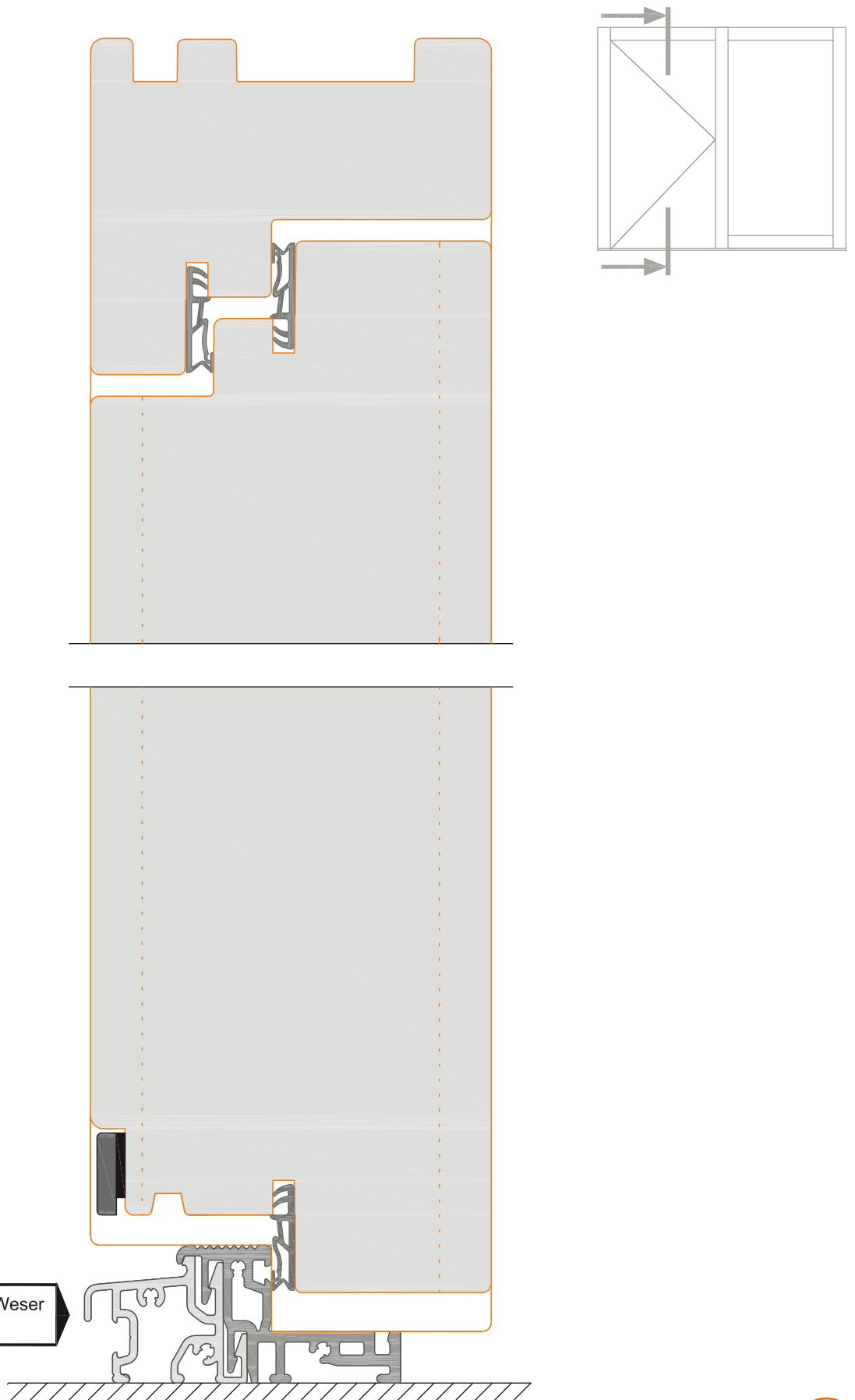

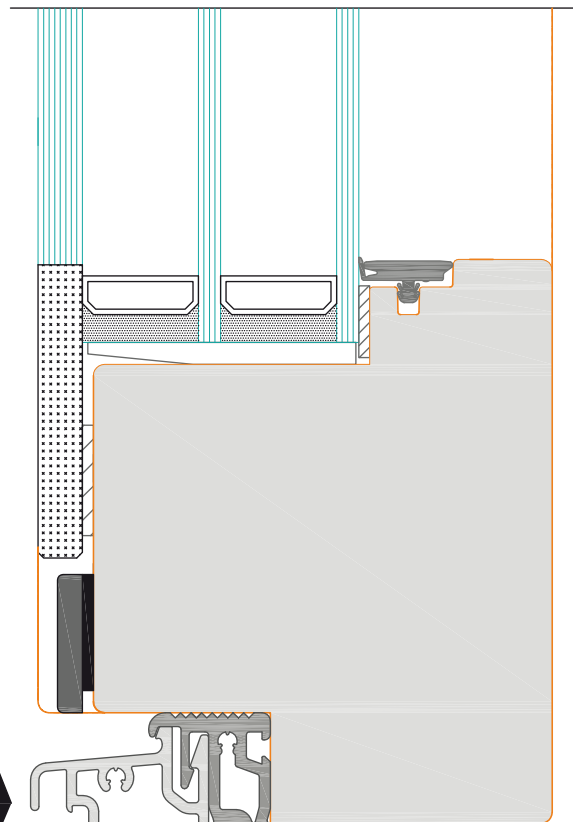
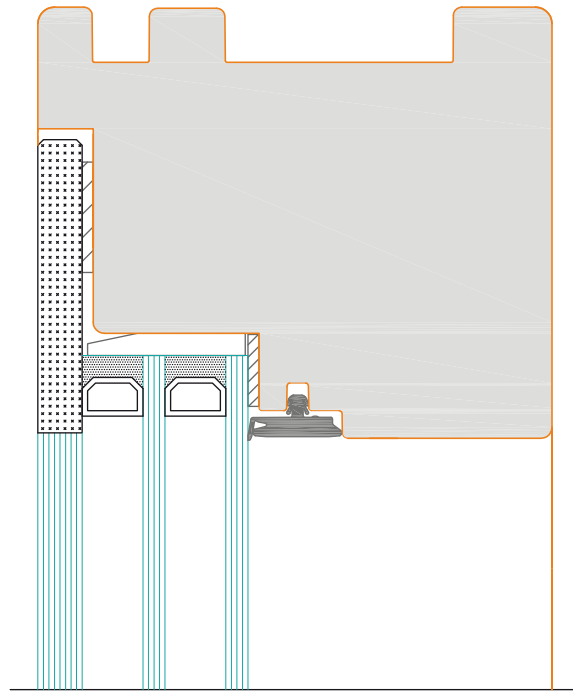
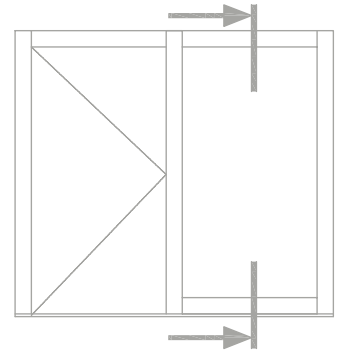

Bodenschwelle Gutmann Weser
75/32 T1

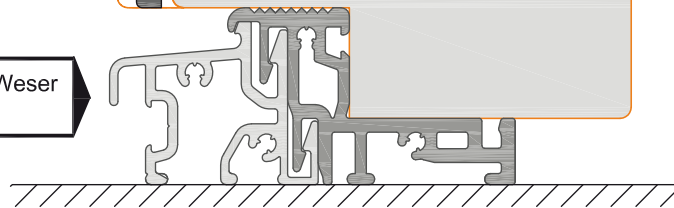

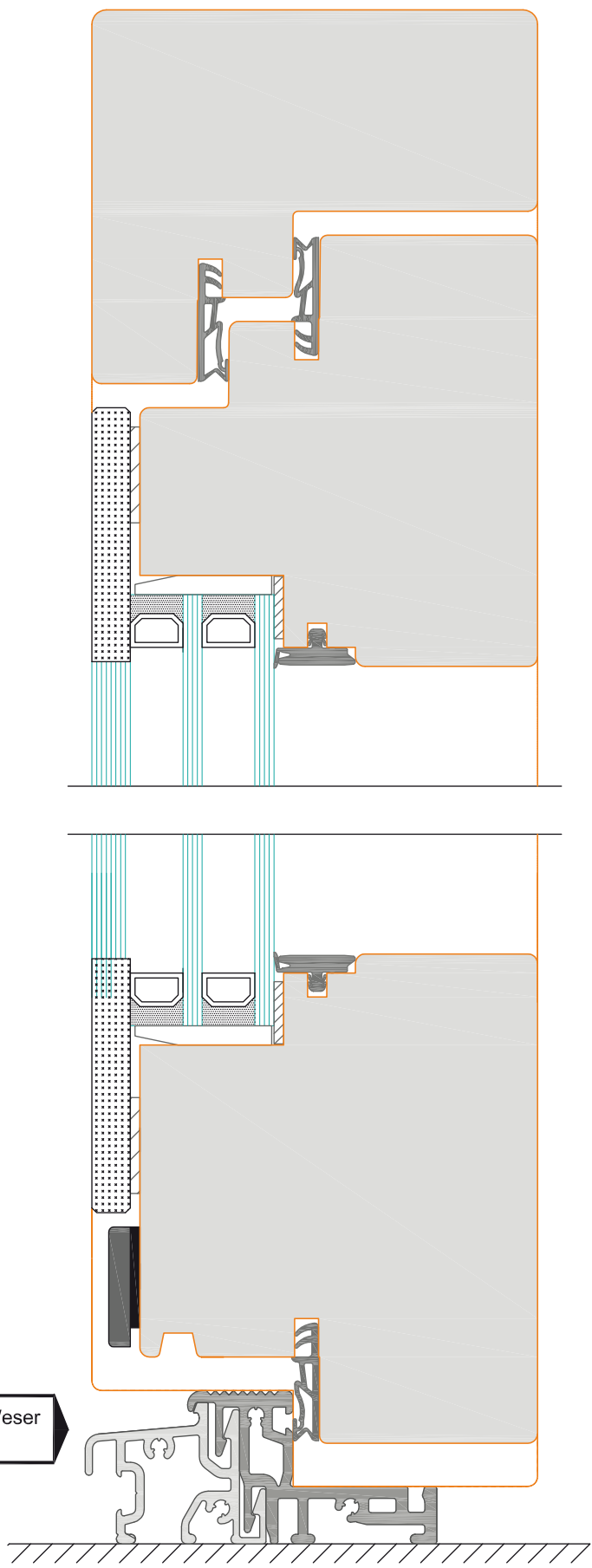
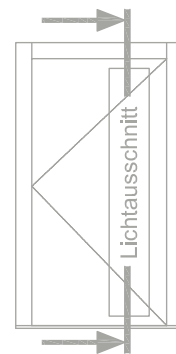

Bodenschwelle Gutmann Weser
75/32 TI





Typ: IP Door 93, beidseitig bündig

Schnitt : Horizontal, Tür mit seitlichem Fixteil

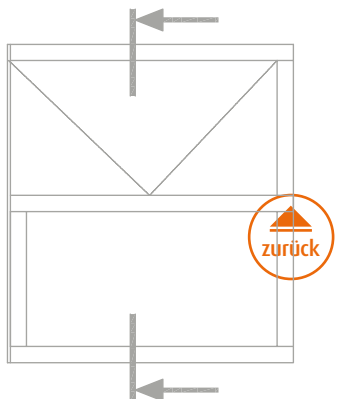
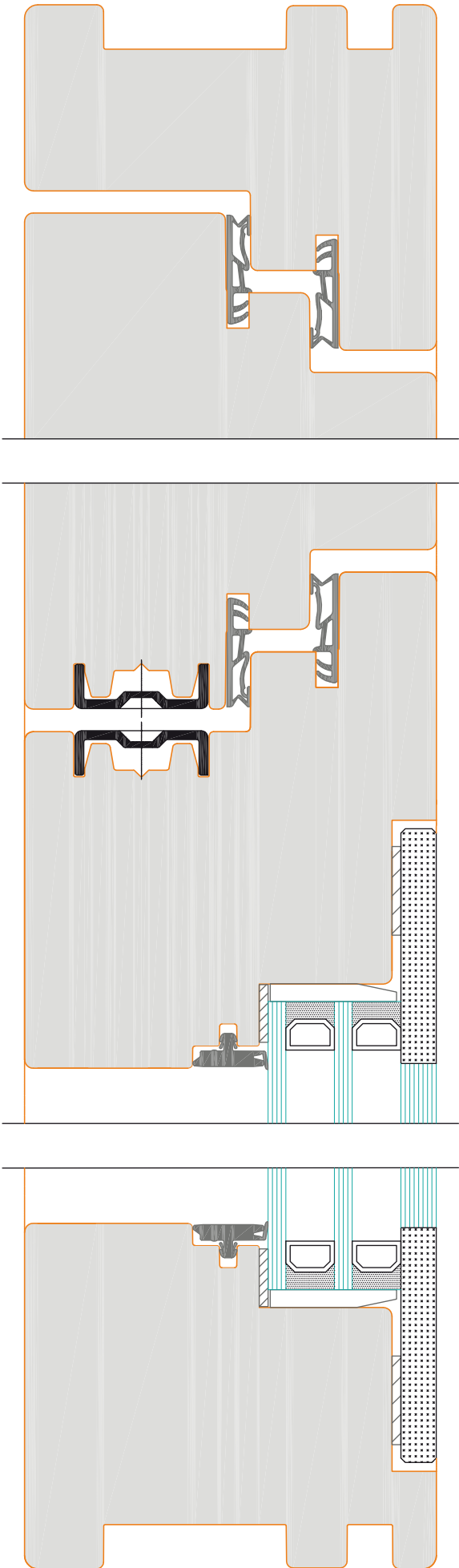



Typ: IP Door 93, beidseitig bündig

Schnitt : Horizontal, Tür mit seitlichem Fixteil

